

WLA
MPS





martinelli luce

La chiave
è la luce
e la luce
rischiara delle forme
e queste forme hanno
una potenza emotiva
per il gioco delle proporzioni
per il gioco dei rapporti
stupefacenti, inattesi

– Le Corbusier

Le Corbusier per Notre Dame
du Haut, Ronchamp
Le Corbusier for Notre Dame
du Haut, Ronchamp



LIGHT FOR LIFE

Ogni lampada non è solo una fonte di luce ma la sua interpretazione.

Martinelli Luce, nata come azienda familiare, negli anni ha saputo emergere nel mondo del design, tanto da guadagnarsi la fiducia e l'apprezzamento degli addetti al settore e del pubblico, consolidando il suo marchio sia in Italia che all'Estero.

Martinelli Luce non ha mai seguito le mode, ma le ha guardate con un occhio sapiente, proseguendo il proprio percorso incentrato sulla tecnologia, funzionalità e minimalismo, con richiami alla geometria delle forme e alla natura. Molte delle lampade rimandano infatti a elementi naturali e a nomi di fiori, di piante, di animali: Serpente, Pipistrello, Cobra, Colibrì, Cicala, Maggiorone, Pulce... Le forme, già concise e iconiche fin dagli inizi dell'Azienda, l'utilizzo di nuovi materiali, nuovi sistemi di stampaggio, nuove sorgenti di luce e nuove tecnologie hanno sempre scandito la filosofia di Martinelli Luce: ovvero creare non solo nuove forme, ma concentrare l'attenzione a risolvere e a proporre innovative soluzioni di illuminazione.

Fondata da Elio Martinelli negli anni '50 nello scantinato di un palazzo storico situato nel centro di Lucca, l'azienda si è poi spostata negli anni '70 nella attuale sede collocata nel verde rigoglioso che circonda la città. Oggi Martinelli Luce, con la figlia Emiliana e il nipote Marco, continua a produrre nuove soluzioni

progettuali con lampade studiate sia internamente, sia da designer esterni.

La storia di Martinelli Luce rappresenta un valore aggiunto importante che è stato difficile da ottenere e che non deve andare disperso; deriva dal lavoro di un insieme di persone che hanno contribuito all'affermarsi dell'azienda. Per questo motivo diverse lampade storiche sono tuttora in catalogo, insieme ai progetti di nuovi designer che hanno ottenuto importanti riconoscimenti internazionali tra cui il Compasso d'Oro.

Tre sono i cataloghi dell'intera collezione: Lampade (decorativo), Architectural e Outdoor, per rispondere alle varie esigenze architettoniche e domestiche.

Il presente catalogo raccoglie la produzione dedicata alla casa anche se molti degli apparecchi proposti possono avere una loro collocazione in ambienti commerciali o professionali. Per il settore tecnico e l'outdoor si rimanda ai cataloghi specifici ed al sito aziendale dove è illustrato anche l'importante lavoro be-spoke che Martinelli Luce ha sempre curato e che continua anche oggi a seguire, customizzando lampade di serie o realizzando apparecchi specifici che seguono le richieste progettuali degli architetti per i vari contesti architettonici e il contract.

LIGHT FOR LIFE

A lamp is not just a light source but its own interpretation.

Martinelli Luce, a company established as a family business, over the years has been able to stand out in the world of design, to the point of gaining the trust and appreciation of both the industry and the public, consolidating its brand both in Italy and abroad.

Martinelli Luce has never followed trends, but has looked at them with a wise eye, pursuing its own path centred on technology, functionality, minimalism, with references to the geometry of shapes and nature. Many of the lamps refer to natural elements and the names of flowers, plants and animals: Serpente, Pipistrello, Cobra, Colibri, Cicala, Maggiolone, Pulce... The shapes, already pure and iconic since the beginning of the Company, the use of new materials, new moulding systems, new light sources and new technologies have always marked Martinelli Luce's philosophy: that is, to create not only new shapes, but to focus on solving and proposing innovative lighting solutions.

Founded by Elio Martinelli in the 1950s in the basement of a historic building in the centre of Lucca, the company moved in the 1970s to its current location in the luxuriant greenery surrounding the city. Today Martinelli Luce, LED by his daughter Emiliana and grandson Marco, continues to produce new design

solutions with lamps created both in-house and by external designers. The history of Martinelli Luce represents an important added value that has been difficult to achieve and must not be dispersed; it derives from the work of a group of people who have contributed to the company's success.

Several historic lamps are still in the catalogue, together with projects by new designers who have won important international awards including the Compasso d'Oro. The entire collection is divided into three catalogues: Lamps (decorative), Architectural and Outdoor, to meet various architectural and domestic requirements.

This catalogue brings together the production dedicated to the home, although many of the fixtures proposed can be used in commercial or professional environments. For the technical and outdoor sector, please refer to the specific catalogues and to the company's website, which also illustrates the important bespoke work that Martinelli Luce has always taken care of and continues to do today, customising standard lamps or creating specific fixtures that follow the design requests of architects for various architectural and contract contexts.



Foto di Aldo Ballo

STORY

1950

Primo logo dell'azienda con la "P" di Plinio il babbo di Elio e la "M" di Martinelli, trasformato poi nel 1969 con il marchio attuale.

The company's first logo with the "P" of Plinio, Elio's father, and the "M" of Martinelli, later transformed into the current brand in 1969.



1960-61

Le prime partecipazioni alla fiera di Milano.

The first exhibition at the fair in Milan.

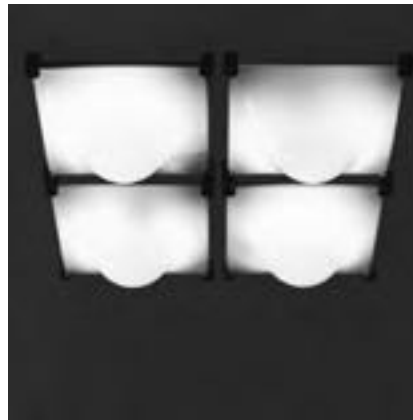
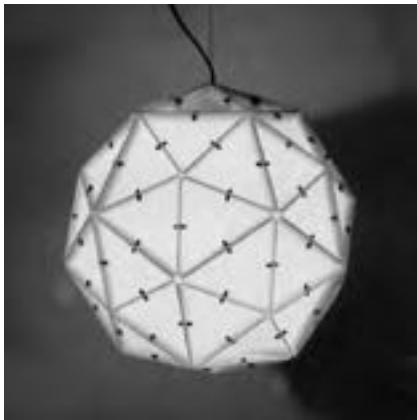

1962

Inizia la sperimentazione del materiale plastico: il metacrilato da cui è partito, con il suo utilizzo per molte lampade, il vero sviluppo dell'azienda.

Vengono progettate le lampade Poliedro (1962) con elementi modulari stampati e Bolla (1965) stampata per termoformatura.

Experimentation with plastics begins: the methacrylate, from which the company's real development started with its use for many lamps.

The Poliedro lamp (1962) with moulded modular elements and Bolla lamp (1965) by thermoforming were designed.

1965

Alcuni esempi di lampade con i diffusori in metacrilato in cui è evidente il sottosquadro eseguito in fase di lavorazione con stampi per termoformatura, studiati e realizzati all'interno dell'azienda.

Le lampade Serpente 1965 e Relax 1968.

A few examples of lamps with methacrylate diffusers in which the undercut made during processing with thermoforming moulds is evident, designed and manufactured within the company.

Serpente 1965 and Relax 1968.





1965

Elio Martinelli incontra l'architetto Gae Aulenti tramite il caro amico Sergio Camilli di Poltronova. Ha inizio la storia della lampada Pipistrello.

Elio Martinelli met architect Gae Aulenti through his dear friend Sergio Camilli of Poltronova. The story of Pipistrello begins.

1966

La 1° edizione di Eurodomus a Genova dove Elio Martinelli viene invitato dall'architetto Gio Ponti a partecipare. Seguirono poi le edizioni del 1967 a Torino, del 1970 a Milano e del 1972 a Torino.

The 1st edition of Eurodomus in Genoa where Elio Martinelli was invited by architect Gio Ponti to attend. This was followed by editions in 1967 in Turin, 1970 in Milan and 1972 in Turin.



1968

In questo anno nasce la lampada Cobra, stampata con materiale termoindurente, in vari colori. Nello stesso anno inizia la collaborazione con l'architetto Sergio Asti che progetta Profiterolle e la lampada Visiere.

In this year the Cobra lamp was created, moulded with thermosetting material, in various colours. In the same year the collaboration with the architect Sergio Asti began, who designed Profiterolle and the Visiere lamp.

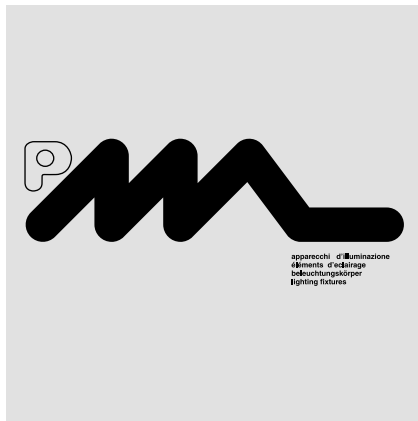

1968

Viene realizzata la lampada Ruspa progettata dall'architetto Gae Aulenti nella versione singola e a 4 elementi.

The Ruspa lamp designed by architect Gae Aulenti is produced in the single and 4-element versions.

1969

Elio Martinelli studia il nuovo marchio tuttora utilizzato dall'azienda con minime variazioni.

Elio Martinelli designed the new brand, which is still used by the company today with only minimal variations.

1969

La lampada Flex come esempio della componibilità caratteristica della filosofia aziendale.

The Flex lamp as an example of the modularity that is characteristic of the company's philosophy.



1972

La lampada Uni 672 di Elio Martinelli esposta a Lubiana a Bio7 e premiata con la menzione d'onore al Compasso d'oro ADI 1979.

Elio Martinelli's Uni 672 lamp exhibited in Ljubljana at Bio7 and awarded an honourable mention at the Compasso d'oro ADI 1979.



1974

Viene realizzato Box, un cubo componibile, un unico pannello in metallo assemblato con viti e dadi, 5 pannelli formano un Box.

Box modular cube, a single metal panel assembled with screws and nuts, 5 panels form a Box.

1976

Nasce la lampada Elmetto stampata in resina in vari colori.

The Elmetto lamp was born, moulded in resin in various colours.

1979

Con il versatile faretto Virgola, da parete e da terra, nasce l'idea di un sistema per il contract con l'utilizzo delle lampade alogene.

With the versatile Virgola wall and floor spotlight, the idea of a system for the contract sector was born, with the use of halogen lamps.



1981

Bolla, Serpente e Pipistrello sono presenti alla mostra "Dive luminose" a Milano dedicata alle lampade preferite dal pubblico dagli anni '30 agli anni '80.

Bolla, Serpente and Pipistrello are exhibited at the "Dive luminose" exhibition in Milano dedicated to the public's favourite lamps from the 1930s to the 1980s.



1984

La natura è l'ispirazione di Elio, nasce la lampada "Le rondini".

Nature is Elio's inspiration, "Le rondini" lamp was born.

1984

Martinelli Luce inizia a produrre lampade per l'outdoor.

Nascono i sistemi Out e Polo stampati in resina e in alluminio nelle versioni da terra, parete e a sospensione.

Martinelli Luce started producing lamps for outdoor use.

The Out and Polo systems were born moulded in resin and in aluminium, in the floor, wall and suspension versions.



STORY

1988

L'azienda oltre che alle lampade per interno si indirizza verso apparecchi a carattere tecnico, nasce il Sistema Z in varie tipologie, utilizzando le sorgenti di luce ad alogene dicroiche e AR111.

In addition to indoor lamps, the company also focuses on technical devices. The Z-System was created in various types, using dichroic halogen and AR111 light sources.

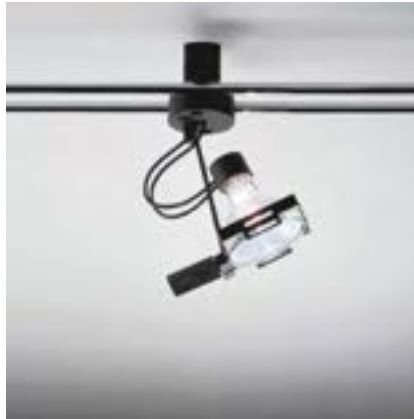

1989

Viene progettata la lampada Charles, omaggio all'architetto e designer Charles Rennie Mackintosh.

The Charles lamp is designed, a tribute to the architect and designer Charles Rennie Mackintosh.

La lampada Pipistrello entra a far parte delle collezioni del Metropolitan Museum of Art di New York.

The Pipistrello lamp joins the collections of the Metropolitan Museum of Art in New York.

1990

Inizia una serie di soluzioni tecniche per spazi pubblici. Viene progettato il Sistema ZH in varie tipologie con l'utilizzo delle sorgenti di luce alogene e a ioduri metallici.

A series of technical solutions for public spaces starts. The ZH System is designed in various types using halogen and a metal-halide light source.



1991

Incontro con Ralf figlio dell'architetto Richard Neutra, e inizio della produzione di due lampade disegnate dal padre. La lampada Marx del 1928 nata per la casa del dottor Marx e la lampada da terra V.D.L. del 1931.

Meeting with Ralf, son of Richard Neutra, and start of production of two lamps designed by his father. The Marx lamp from 1928 created for Dr. Marx's house and the V.D.L. floor lamp from 1931.



1993

Nascono gli apparecchi 2003 e 1893 sospensioni di grandi dimensioni per l'illuminazione di grandi spazi commerciali, con l'utilizzo di lampade a ioduri metallici.

The 2003 and 1893 fixtures were born, large pendants for lighting large commercial spaces, with metal halide light sources.

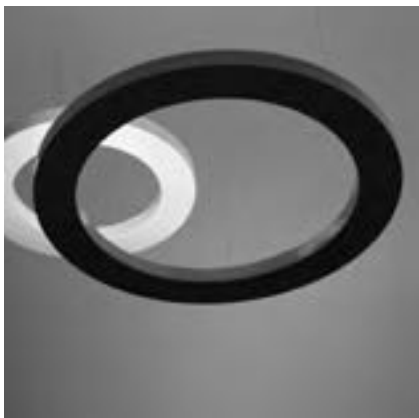

1995

Circular, la prima lampada ad anello presentata in occasione della fiera tecnica "Intel" nel padiglione della meccanica a Milano.

Circular, the first ring lamp presented at the "Intel" technical fair in the mechanics pavilion in Milan.

1998

Sempre inerenti alla componibilità, nasce da Elio e Emiliana la lampada Nuvole Vagabonde in diversi diametri, formata da elementi sovrapposti in metacrilato opal bianco.

Nuvole Vagabonde in different diameters, still related to modularity, was created by Elio and Emiliana. A lamp composed of overlapping white opal methacrylate elements.



2003

ADI Design Index 2003 seleziona il sistema componibile Shanghai. Disegnato dallo Studio Lucchi e Biserni e Angelo Micheli con l'utilizzo di moduli per tubi fluorescenti che vanno a formare giochi ed effetti di luce nello spazio.

ADI Design Index 2003 selects the modular system Shanghai. Designed by Studio Lucchi e Biserni and Angelo Micheli with the use of modules for fluorescent tubes that form games and light effects in the space.



2009

Nasce nel 2009 il sistema Colibrì a LED, minimale, studiato su richiesta per l'allestimento della mostra "Mito e bellezza (Napoleone ed Hermès)" a Lucca. Premiato con iF Product Design Award 2013 e con il German Design Award 2014. Progetto che ha dato origine a numerose versioni di diversa tipologia.

The minimalist Colibrì LED system for the exhibition "Myth and Beauty (Napoleon and Hermès)" in Lucca, was created in 2009. Awarded the iF Product Design Award 2013 and German Design Award 2014. Project that has given rise to numerous versions of different typologies.



2009

Sempre per grandi spazi, Emiliana progetta, con l'utilizzo del polietilene e la tecnologia rotazionale, Circular Pol in vari diametri e Circular Pol XXL con moduli componibili per creare percorsi senza limiti. Premiato con iF Product Design Award 2014. Con la solita tecnologia nasce il sistema Mamba nel 2017.

Also for large spaces, Emiliana designs, using polyethylene and rotational moulding technology, Circular Pol in various diameters and Circular Pol XXL with modular modules to create pathways. Awarded with iF Product Design Award 2014.

The Mamba system was born in 2017.

2009

Un giovane designer Brian Sironi presenta a Martinelli Luce la lampada Elica. Molti sono i premi e i riconoscimenti ottenuti, tra cui il Compasso d'oro ADI 2011.

Elica è poi presente nel 2011 nella mostra "The new Italian design" alla Triennale di Milano e a Istanbul.

Young designer Brian Sironi presents the Elica lamp at Martinelli Luce. Awarded the Compasso d'Oro ADI 2011.

Elica was present in 2011 in the exhibition "The new Italian design" at the Triennale di Milano and in Istanbul.



2011-2013

La lampada Toy dei giovani designer Studio 4P1B è segnalata ad ADI Design Index 2011 e al Good Design Awards di Chicago nel 2013. La lampada Fluida di Studio Natural è premiata con ADI Design Index 2012 e poi con la Menzione d'onore al Compasso d'oro 2014.

The Toy lamp by the young designers Studio 4P1B is mentioned at the ADI Design Index 2011 and at the Good Design Awards in Chicago in 2013. The Fluida lamp by Studio Natural was awarded the ADI Design Index 2012 and then an Honourable Mention at the Compasso d'oro 2014.



2013

Inaugura la mostra "Gae Aulenti, gli oggetti, gli spazi" alla Triennale di Milano a cura di Vanni Pasca e studio Gae Aulenti architetti associati.

The exhibition "Gae Aulenti, gli oggetti, gli spazi" opens at the Milan Triennale curated by Vanni Pasca and studio Gae Aulenti architetti associati.



2011

Installazione "Zero Progetto" per "Interni Mutant" a Milano e Carrara con Studio Snøhetta e l'architetto Paolo Armenise.

"Zero Project" installation for "Interni Mutant" – Milan and Carrara with Studio Snøhetta and architect Paolo Armenise.

2012

Installazione per "Interni Legacy" con lo studio Som/Skidmore, Owings & Merrill e l'architetto Paolo Armenise a Milano.

Installation for "Interni Legacy" with Som/Skidmore, Owings & Merrill and architect Paolo Armenise in Milano.

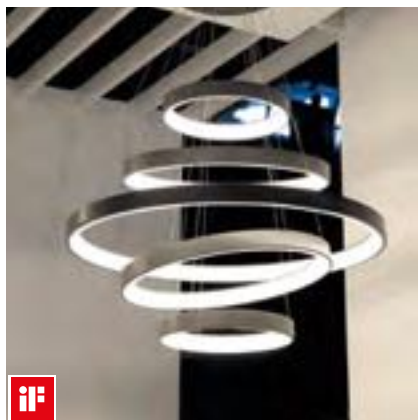

2014

Nasce la serie Lunaop di Emiliana Martinelli con l'utilizzo delle nuove sorgenti a LED. Lampade ad anello in alluminio in vari diametri, nelle versioni singole o composte.

Premiata con iF Product Design Award 2015.

The Lunaop series by Emiliana Martinelli were born with the use of new LED sources. Aluminium ring lamps in various diameters, in single or compound versions.

Awarded with iF Product Design Award 2015.

2015

Evento all'Istituto Italiano di Cultura a Parigi per i 50 anni della lampada Pipistrello. Viene realizzata la versione dorata e una edizione speciale firmata e numerata in oro 24K in 50 esemplari.

Event at the Italian Cultural Institute in Paris for the 50th anniversary of the Pipistrello lamp. The golden version and a special edition signed and numbered in 24K gold in 50 pieces.

Nasce la lampada Ciulifruli componibile in vari colori di Atelier(s) A. Femia e E. Martinelli.

The modular Ciulifruli lamp in various colours by Atelier(s) A. Femia and E. Martinelli.



2017

Inizia il tema del comfort acustico con l'utilizzo dei materiali fonoassorbenti con le lampade Lent (2017) di Studio Yonoh premiata con iF Product Design Award 2018 e Hush di Massimo Farinatti (2019) premiata con iF Product Design Award e ADI Design Index 2020.

The topic of acoustic comfort began with the use of sound-absorbing materials with the lamps Lent 2017 by Studio Yonoh awarded with iF Product Design Award 2018 and Hush by Massimo Farinatti 2019 awarded with iF Product Design Award and ADI Design Index 2020.



2018

Per i suoi 50 anni la lampada Cobra di Elio Martinelli si veste di rosso e 23 designer partecipano al progetto "Cobra Texture" presentato alla Triennale di Milano, con una loro grafica applicata sulla lampada. Viene organizzato il concorso under 35 "Cobra Re-loaded".

For its 50th anniversary, Elio Martinelli's Cobra lamp is dressed in red and 23 designers participated in the "Cobra Texture" project presented at the Triennale di Milano with their own graphics applied to the lamp. The under-35 "Cobra Re-loaded" award is organised.



2018

Mostra dedicata ad Elio Martinelli e la Martinelli Luce presso la Triennale di Milano in occasione dei 70 anni dell'azienda. Pubblicazione del libro "Elio Martinelli e la Martinelli Luce" a cura di Emiliana Martinelli edito da Mondadori-Electa, Milano.

Exhibition dedicated to Elio Martinelli and Martinelli Luce at the Triennale di Milano on the occasion of the company's 70th anniversary.

Publication of the book "Elio Martinelli e la Martinelli Luce" edited by Emiliana Martinelli and published by Mondadori-Electa, Milan.



2019

In occasione di Lucca Comics & Games Martinelli Luce rende omaggio a Guido Crepax con una mostra nel proprio Showroom a Lucca e con l'edizione speciale della lampada Civetta di Emiliana con la texture dedicata a Valentina. Allestimento con i cartoons Baleri.

On the occasion of Lucca Comics & Games Martinelli Luce paid tribute to Guido Crepax with an exhibition in its Showroom in Lucca and with the special edition of the Civetta lamp with texture dedicated to Valentina. Set-up with Baleri cartoons.

2019

Martinelli Luce Illumina la mostra "Museo della follia" a cura di Vittorio Sgarbi e realizzata dal gruppo Contemplazioni. Presso lo spazio la Cavallerizza, Lucca. La collaborazione è continuata per la mostra "I pittori della Luce" nel 2021.

Lighting for the itinerant exhibition "Museo della follia" curated by Vittorio Sgarbi and produced by the Contemplazioni group. At the space Cavallerizza, Lucca. The collaboration continued for the exhibition "I pittori della Luce" in 2021.



2019

Vengono progettate diverse lampade per l'outdoor utilizzando il cemento ad alta resistenza con idrorepellente. Le lampade Pont di Marc Sadler, Cyborg di Karim Rashid, Koala di Emiliana Martinelli e altre presenti nel catalogo outdoor.

Various lamps are designed for outdoor use using high-strength water-repellent concrete. The Pont lamps by Marc Sadler, Cyborg by Karim Rashid, Koala by Emiliana Martinelli and others in the outdoor catalogue.



2019

Con lo Studio Habits viene proposta la lampada Elastica, una striscia in tessuto elastico che grazie alla streep LED e al particolare circuito, tirandola, si accende, si dimmera, si spegne. Premiata con iF Product Design Award, ADI design Index e il Premio per l'innovazione 2020.

Studio Habits proposes the Elastica lamp, a strip of elastic fabric which, thanks to the LED strip and the special circuit, can be turned on, dimmed and turned off by pulling it. Awarded with iF Product Design Award, ADI design Index and Innovation Award 2020.

2020

Martinelli Luce è presente al Vitra Design Museum e alla Zagabria Design Week.

Martinelli Luce exhibits at Vitra Design Museum and Zagreb Design Week.

Un anno difficile e complesso per la pandemia che passerà alla storia. Nasce l'idea della lampada per outdoor Frog, in polietilene, colorata e divertente, realizzata poi nel 2021.

A difficult and complex year for the pandemic that will go down in history. The Frog outdoor lamp is born, in polyethylene colour, fun and fun.



2020

Progetto "Light you like" che attraverso la tecnologia Bluetooth consente di modulare e controllare l'intensità e la temperatura del colore con semplici controlli touch su smartphone e tablet e regolare più dispositivi illuminanti adattando la luce alle tue esigenze. (Pipistrello, Biconica, TX1)

"Light you like" project that through Bluetooth technology allows you to modulate and control the intensity and temperature of the colour with simple touch controls on smartphones and tablets and adjust multiple lighting devices to suit your needs. (Pipistrello, Biconica, TX1)



2021

Allestimento di due vetrine presso La Rinascente di Milano, una con alcune lampade storiche simbolo dell'azienda e l'altra dedicata alle ultime proposte. Partecipazione alla 26th Shenzhen International Furniture Fair con una selezione di lampade.

Setting up of two shop window displays at La Rinascente in Milan, one displaying some of the company's historic iconic lamps and the other dedicated to its latest proposals. Participation in the 26th Shenzhen International Furniture Fair with a selection of lamps.

2021

Dalle collaborazioni con designer come Peluffo&Partners e Neil Poulton nascono le nuove lampade: la sospensione Lady Galala (iF Product Design Award 2022) componibile e la lampada da parete orientabile Toggle.

From collaborations with designers such as Peluffo&Partners and Neil Poulton come the new lamps: the modular Lady Galala (iF Product Design Award 2022) hanging lamp and the adjustable Toggle wall lamp.



2021

Le lampade Pistillo illuminate con il tricolore al Quirinale e alla residenza presidenziale villa Rosebery a Posillipo.

The Pistillo lamp lit with the tricolour at the Quirinale and the presidential residence Villa Rosebery in Posillipo.

Le lampade Biconica e Pipistrello alla mostra "Together" organizzata dalla rivista IQD al negozio Olivetti di Venezia, progettato da Carlo Scarpa.

The Biconica and Pipistrello lamps at the "Together" exhibition organised by IQD magazine at the Olivetti shop in Venice, designed by Carlo Scarpa.

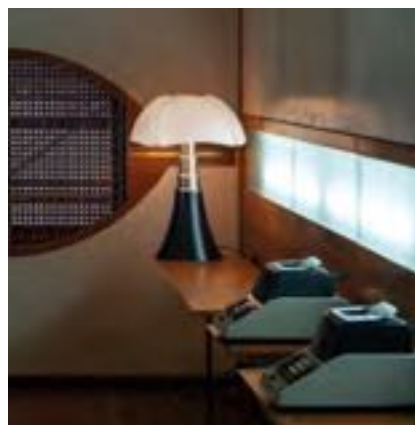

2021-2022

Continua la progettazione di nuove lampade con Studio Habits l'ultimissimo prototipo della lampada Metrica nelle varie versioni parete, tavolo, terra.

The design of new lamps using different materials continues, the latest prototype of the Metrica, wall, table, floor lamp, designed by Studio Habits.

Riedizione della lampada Visiere dell'architetto Sergio Asti disegnata nel 1968, nella versione con lampadine LED.

Re-edition of architect Sergio Asti's Visiere lamp designed in 1968, in a version with LED bulbs.

2022

Lo Studio Natural progetta la nuova sospensione Avro con presa di corrente nella parte inferiore del suo diffusore.

Studio Natural designed the new Avro pendant with a power socket at the bottom of its diffuser.

A 100 anni dalla nascita di Elio Martinelli, Martinelli Luce inaugura il Metaverso dedicato al suo fondatore.

100 years after the birth of Elio Martinelli, Martinelli Luce inaugurates its Metaverse dedicated to its founder.



PREMI E RICONOSCIMENTI AWARDS AND ACKNOLEGMENTS



2009
2011
2013



2003
2010
2011
2015
2020
2021
2022



2011
2013
2014
2015
2016
2017
2018
2019
2020
2021
2022



2010



2011

reddot design award



2011



1979
2015



2016
2020
2021
2022



2012
2014

NOMINEE



2021
2022

DESIGNER

Elio Martinelli	Studio Natural
Gae Aulenti	Paola Navone
Sergio Asti	Michel Boucquillon
Richard Neutra	Donia Maaoui
Emiliana Martinelli	Adolini & Simonini
Orlandini Design	Atelier(s) Alfonso Femia
Marc Sadler	Karim Rashid
Marcello Morandini	Michael Geldmacher
Luc Ramael	Martinelli Venezia Studio
Marco Ghilarducci	Studio Habits
Brian Sironi	Simon Schmitz
Lella & Massimo Vignelli	Peluffo&Partners
PLS design - Lorenzo Perini	Neil Poulton
Studio Area-17	Davide Frattini Frilli

#martinelliluce



Una selezione di immagini amatoriali che gli amici di Martinelli Luce hanno postato e continuano a postare su Instagram facendoci vedere come vivono le lampade Martinelli Luce nel loro contesto quotidiano.

A selection of amateur pictures that Martinelli Luce's friends have posted and continue to post on Instagram showing us how Martinelli Luce lamps live in their daily context.





@artconnexion06



@boccutostefania



@annagrassham



@catrinettewien



@cindy_fav



@chat_noir_eka



@lustrodalucca



@codameanstill



@charlottezara1

#martinelliluce



@__modern__way__



@dsarah23

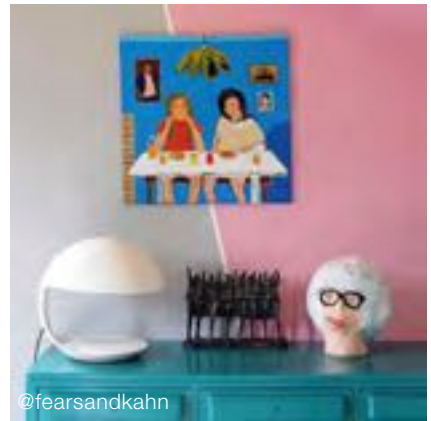

@fearsandkahn



@numbering.day



@garage.209



@garretsmemories

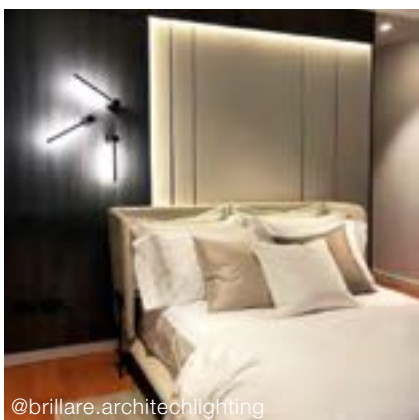

@brillare.architeclighting



@designandlighting



@stillucestore



@madamicellalisandrina



@karim_rashid_official



@p5luminaire

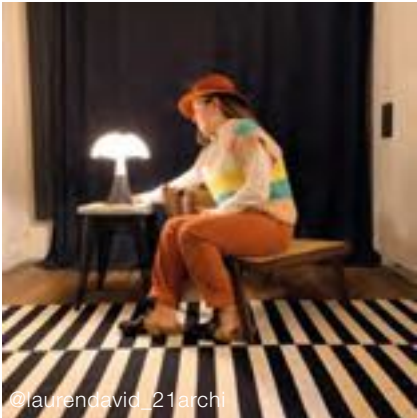

@laurendavid_21archi



@le_grenier_de_galde



@gg_designart

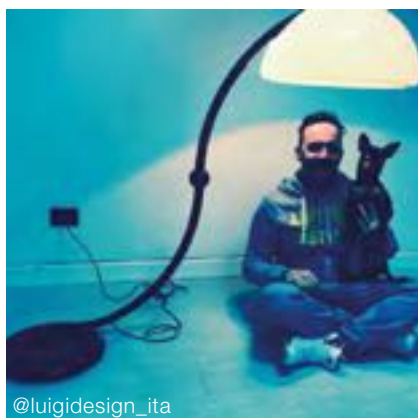

@luigidesign_ita



@lulu_bidouille

#martinelliluce

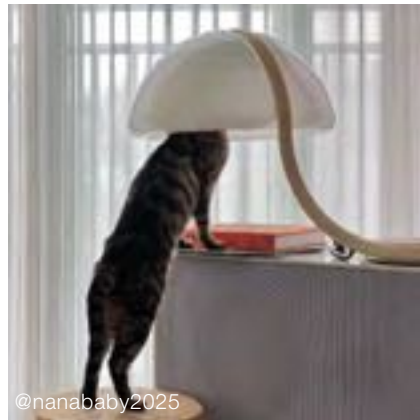



@delloydesign



@roberta_patalani

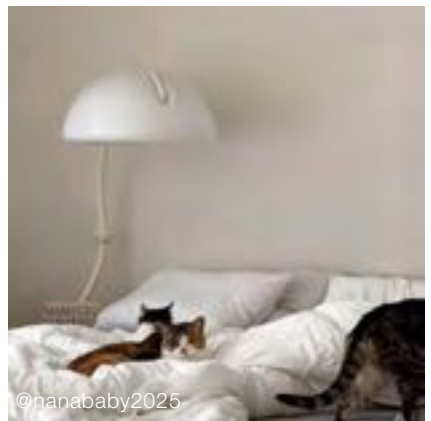

@nanababy2025



@stugalove



@christelle__frn



@lestendancesdedelph



@valentinapalla_



@studio_vintage_hh



@bsn__leo

LIGHTYOULIKE

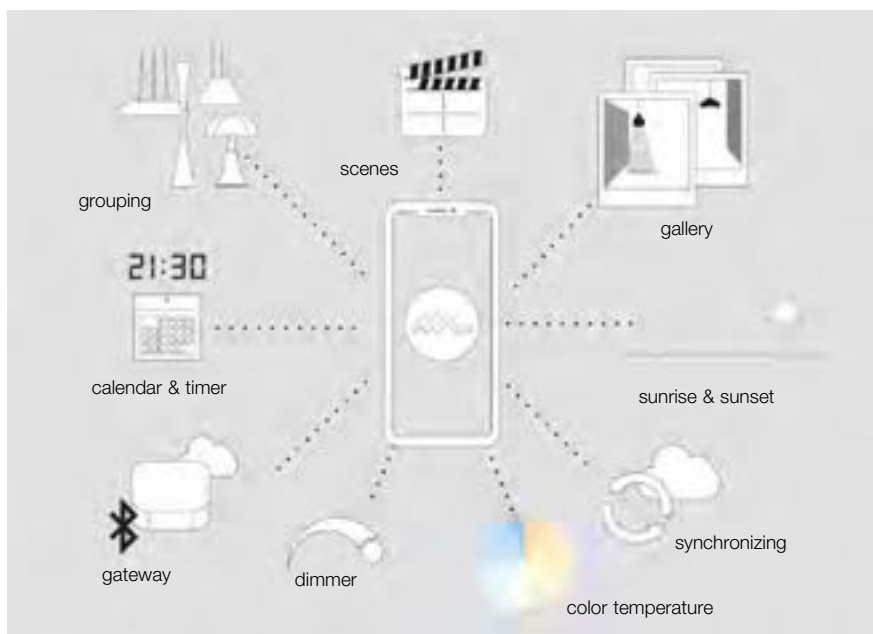

LIGHT YOU LIKE

“Light you like” è un progetto di Martinelli Luce che attraverso la tecnologia “Bluetooth” ti rende protagonista nello spazio del vivere quotidiano per dare vita a una nuova esperienza sensoriale e migliorare il tuo benessere.

Con questa innovazione tecnologica Martinelli Luce offre una luce modulabile grazie al sistema di controllo dell'intensità e per alcuni prodotti della temperatura del colore che ti permette di personalizzare lo spazio abitativo in base alle tue emozioni e sensazioni. Intervenire sull'illuminazione della tua abitazione diventa facile ed intuitivo, grazie all'utilizzo di app compatibili con i sistemi Apple e Android, le quali attraverso semplici controlli touch su smartphone e tablet permettono di regolare più dispositivi illuminanti e di adattare la luce alle tue esigenze.



Con le app è possibile:

- Dimmerare le lampade tramite dispositivo bluetooth, iOS e Android Apps
- Regolare la temperatura della luce in maniera dinamica da 2500 a 6700K (per alcuni prodotti compatibili)
- Creare gruppi di lampade per la sincronizzazione (max 127)
- Creare scene: per accensioni temporali; per accensione/spengimento gruppi di lampade
- Scattare una foto alla lampada e vederla nell'app per semplificare la selezione del prodotto.



“Light you like” is Martinelli Luce's project which, through “Bluetooth” technology, makes you the protagonist in the space of your daily life to give life to a new sensorial experience and improve your well-being.

With this technological innovation, Martinelli Luce offers a modular light thanks to the system of control of the intensity and color temperature allowing you to customize your living space according to your emotions and sensations.

Working on the lighting of your home becomes easy and intuitive, thanks to the use of apps compatible with Apple and Android systems, which through simple touch controls on smartphones and tablets allow you to adjust multiple lighting devices and adapt the light to your needs .

With the apps you can:

- Dim the lamps via bluetooth device, iOS and Android Apps
- Adjust the light temperature dynamically from 2500 to 6700K (for some compatible products)
- Create groups of lamps for synchronization (max 127)
- Create scenes: for temporal lighting; for switching groups of lamps on/off
- Take a photo of the lamp and view it in the app to simplify product selection.



App CASAMBI (Apple Store e Google Play)



INDICE / INDEX

LAMPADE DA TAVOLO TABLE LAMPS	43
LAMPADE A SOSPENSIONE SUSPENSION LAMPS	179
LAMPADE DA TERRA FLOOR LAMPS	277
LAMPADE DA PARETE E DA SOFFITTO WALL OR CEILING LAMPS	377
EDIZIONI SPECIALI SPECIAL EDITIONS	467
HIGHLIGHTS	483
COMPLEMENTI DI ARREDO FURNITURE	527

INDEX

LAMPADE DA TAVOLO / TABLE LAMPS





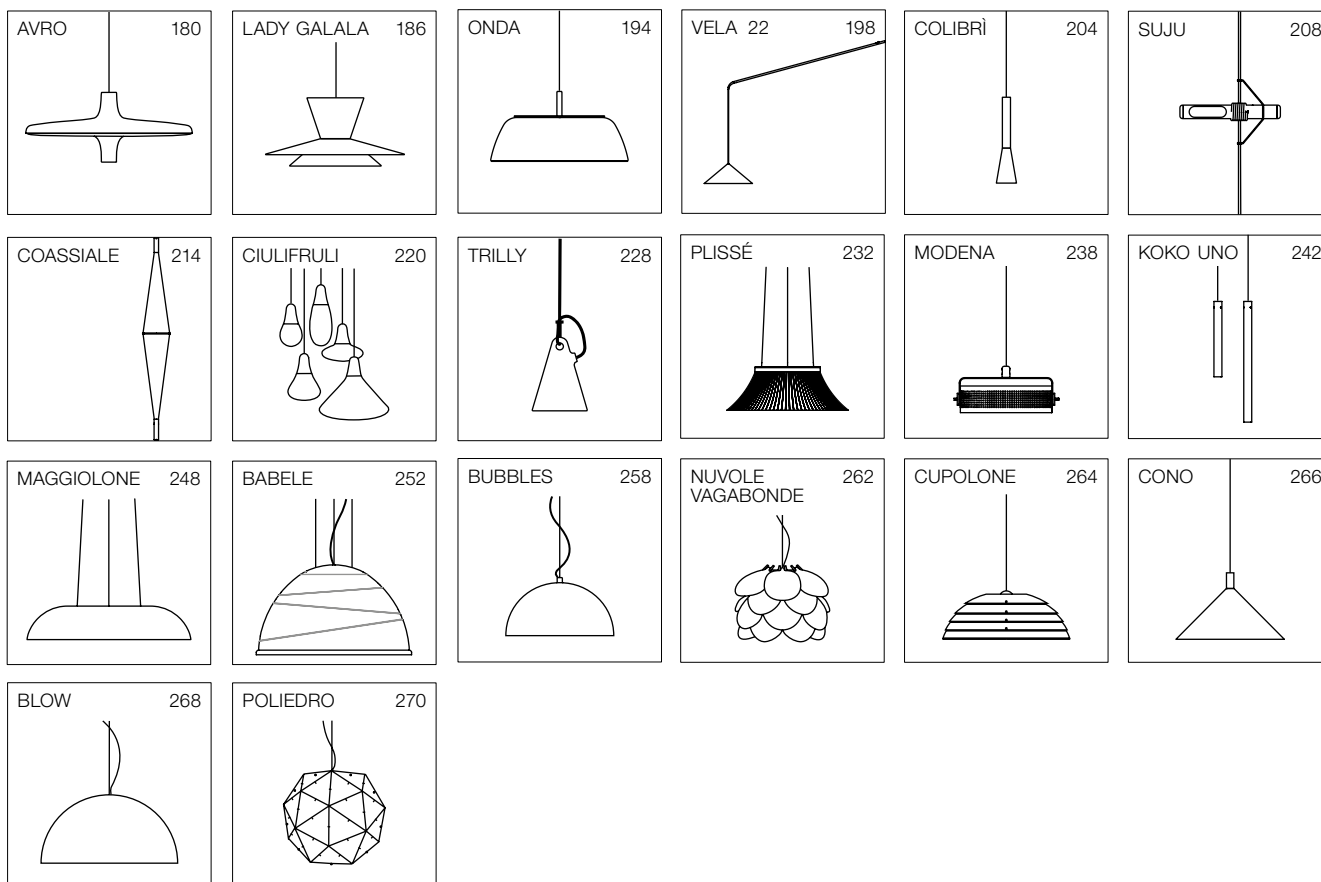





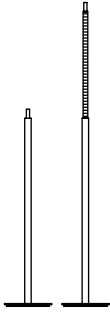
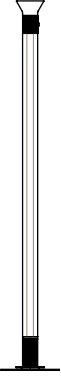

METRICA 44 	CABRIOLETTE 50 	DELUX 56 	KIKI CORDLESS 66 	CYBORG 70 	HOOP 78 
FLUIDA 82 	PULCE 88 	SEGNALIBRO 92 	COLIBRI 96 	ELICA 100 	CIVETTA 106 
TX1 108 	MICO 118 	L'AMICA 122 	ELMETTO 128 	COBRA 132 	PIPISTRELLO 140 
SERPENTE 172 					

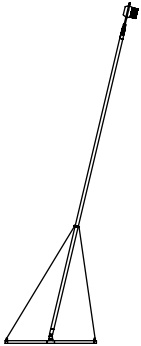
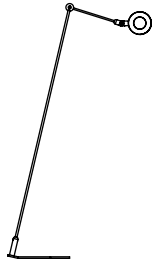
LAMPADE A SOSPENSIONE / SUSPENSION LAMPS

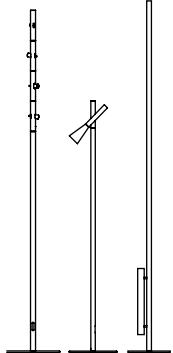
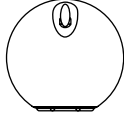
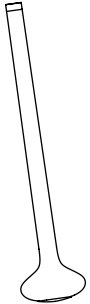

INDEX

LAMPADE DA TERRA / FLOOR LAMPS

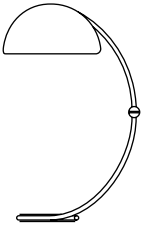
METRICA 278 	DIA 282 	GRU 288 	CABRIOLETTE 292 	FROG 298 	ELASTICA 308 
Y3 316 	L'AMICA 322 	CLOCHARD 324 	COLIBRÌ 328 	BOWL 336 	PIN 340 
EVA 344 	PISTILLONE 352 	PISTILLO 356 	BICONICA POL 358 	BICONICA 366 	SERPENTE 370 

LAMPADE DA PARETE E DA SOFFITTO / WALL AND CEILING LAMPS

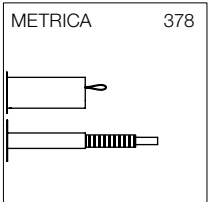
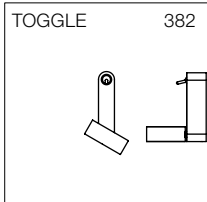
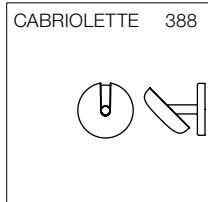
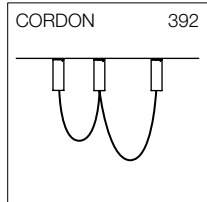
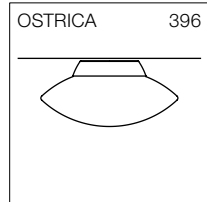
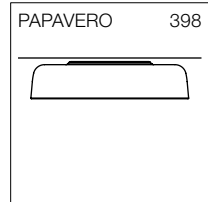
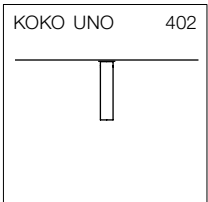
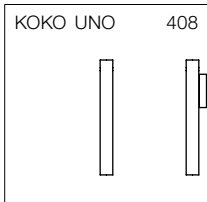
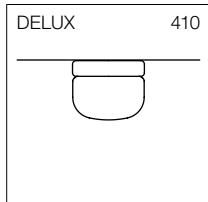
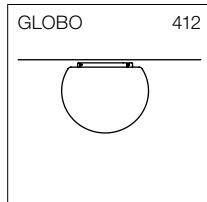
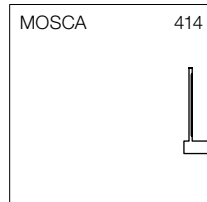
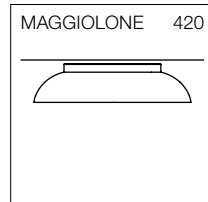
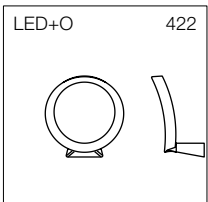
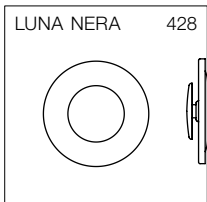
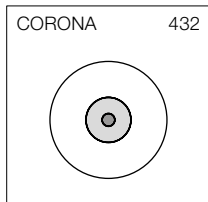
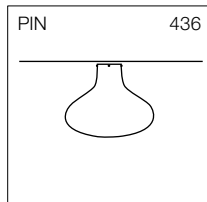
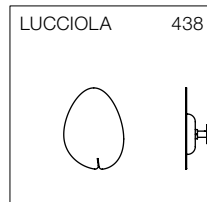
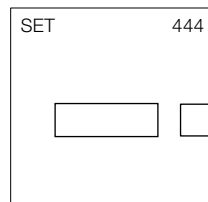
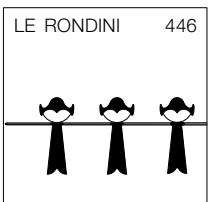
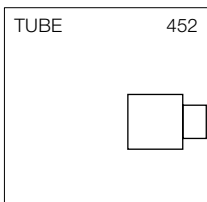
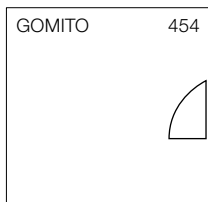
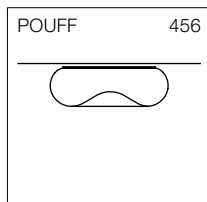
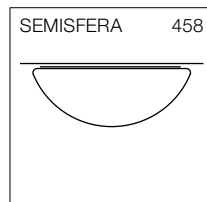
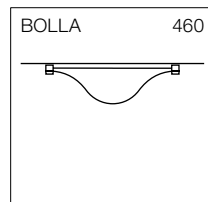
METRICA 378 	TOGGLE 382 	CABRIOLETTE 388 	CORDON 392 	OSTRICA 396 	PAPAVERO 398 
KOKO UNO 402 	KOKO UNO 408 	DELUX 410 	GLOBO 412 	MOSCA 414 	MAGGIOLONE 420 
LED+O 422 	LUNA NERA 428 	CORONA 432 	PIN 436 	LUCCIOLA 438 	SET 444 
LE RONDINI 446 	TUBE 452 	GOMITO 454 	POUFF 456 	SEMISFERA 458 	BOLLA 460 

INDEX

EDIZIONI SPECIALI / SPECIAL EDITION

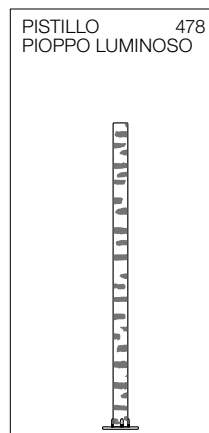
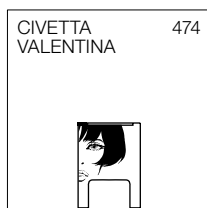

HIGHLIGHTS

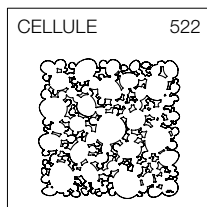
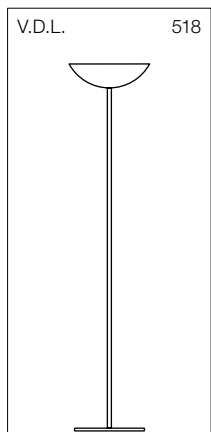
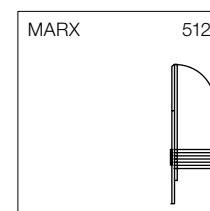
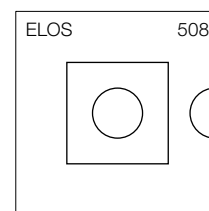
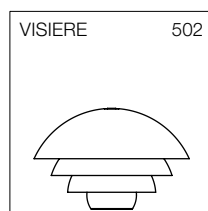
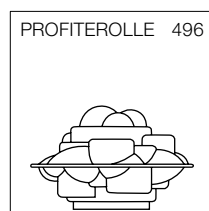
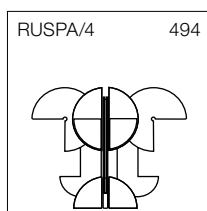
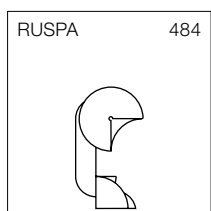

COMPLEMENTI DI ARREDO / FURNITURE

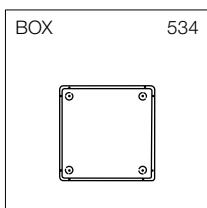
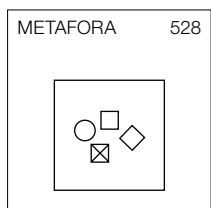



INDICE ALFABETICO PER FAMIGLIE / ALPHABETICAL INDEX BY PRODUCT FAMILY

AVRO	180	ELMETTO	128	PAPAVERO	398
BABALE	252	ELOS	508	PIN	
BICONICA	366	EVA	344	terra / floor	340
BICONICA POL	358	FLUIDA	82	soffitto / ceiling	436
BLOW	268	FROG	298	PIOPPO LUMINOSO	478
BOLLA	460	GLOBO	412	PIPISTRELLO	140
BOWL	336	GOMITO	454	Pipistrello	146
BOX	534	GRU	288	Pipistrello led	148
BUBBLES	258	HOOP	78	Pipistrello 4.0	150
CABRIOLETTE		KIKI CORDLESS	66	Pipistrello med	152
tavolo / table	50	KOKO UNO		Minipipistrello	158
terra/floor	292	sospensione / suspension	242	Minipipistrello cordless	164
parete / wall	388	soffitto-parete / wall-ceiling	402	PISTILLO	356
CELLULE	522	LADY GALALA	186	PISTILLONE	352
CIULIFRULI	220	L'AMICA		PLISSÉ	232
CIVETTA	106	tavolo / table	122	POLIEDRO	270
Civetta Valentina	474	terra / floor	322	POUFF	456
CLOCHARD	324	LE RONDINI	446	PROFITEROLLE	496
COASSIALE	214	LED+O	422	PULCE	88
COBRA	132	LUCCIOLA	438	RUSPA	484
Cobra scorpius	468	LUNA NERA	428	SEGNALIBRO	92
COLIBRÌ		MAGGIOLONE		SEMISFERA	458
tavolo / table	96	sospensione / suspension	248	SERPENTE	
sospensione / suspension	204	soffitto / ceiling	420	tavolo / table	172
terra / standing	328	MARX	512	terra / floor	370
CONO	266	METAFORA	528	SET	444
CORDON	392	METRICA		SUJU	208
CORONA	432	tavolo / table	44	TOGGLE	382
CUPOLONE	264	terra / standing	278	TRILLY	228
CYBORG	70	parete / wall	378	TUBE	452
DELUX		MICO	118	TX1	108
tavolo / table	56	MODENA	238	V.D.L.	518
soffitto / ceiling	410	MOSCA	414	VELA 22	198
DIA	282	NUVOLE VAGABONDE	262	VISIERE	502
ELASTICA	308	ONDA	194	Y3	316
ELICA	100	OSTRICA	396		



LAMPADE DA TAVOLO
TABLE LAMPS



METRICA

Interattiva, tecnologica e divertente. La magia della luce che prende forma nel momento in cui viene estratta. Metrica prende il nome dal classico strumento di misurazione, ispirandosi al medesimo gesto di estrazione: infatti la sorgente di luce a LED può essere estratta o riposizionata all'interno del corpo lampada replicando lo stesso movimento del metro. È su questo gioco fra tecnologia ed estetica che risiede l'unicità di Metrica. Infatti al suo interno vi è un sensore che legge l'alternanza del bianco e del nero presenti nella struttura mobile, regolandone così la luminosità. La sorgente di luce a LED, nascosta all'interno del supporto che forma la base, si accende nel momento in cui viene estratta, aumentando progressivamente di intensità fino a raggiungere la posizione massima. Si spegne mano a mano che ritorna all'interno della base.



Interactive, technological and fun. The magic of the light that takes shape the moment it is extracted. Metrica takes its name from the classic measuring instrument, inspired by the same gesture of extraction: in fact, the LED light source can be extracted or repositioned inside the body lamp by replicating the same movement of the meter. The uniqueness of Metrica lies in this interplay of technology and aesthetics. In fact, there is a sensor inside the movable structure that reads the alternation of black and white, thus adjusting the brightness. The LED light source, hidden inside the support that forms the base, lights up as soon as it is extracted, gradually increasing in intensity until it reaches its maximum position. It switches off as it returns to the base.

STUDIO HABITS





METRICA

STUDIO HABITS



Lampada da tavolo a luce diretta che si accende e si spegne quando la sorgente di luce a LED viene estratta o riposizionata all'interno del corpo lampada.

Struttura in alluminio estruso verniciato nel colore bianco o nero, base nel colore bianco.

Alimentatore a spina.

Direct light table lamp that switches on and off when the LED light source is removed or repositioned inside the lamp body.

Extruded aluminium frame painted in white or black, base in white.

Driver on plug.

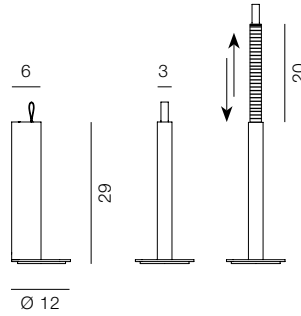

8W LED 340lm 3000K

833/BI ○ bianco / white

833/NE ● nero / black

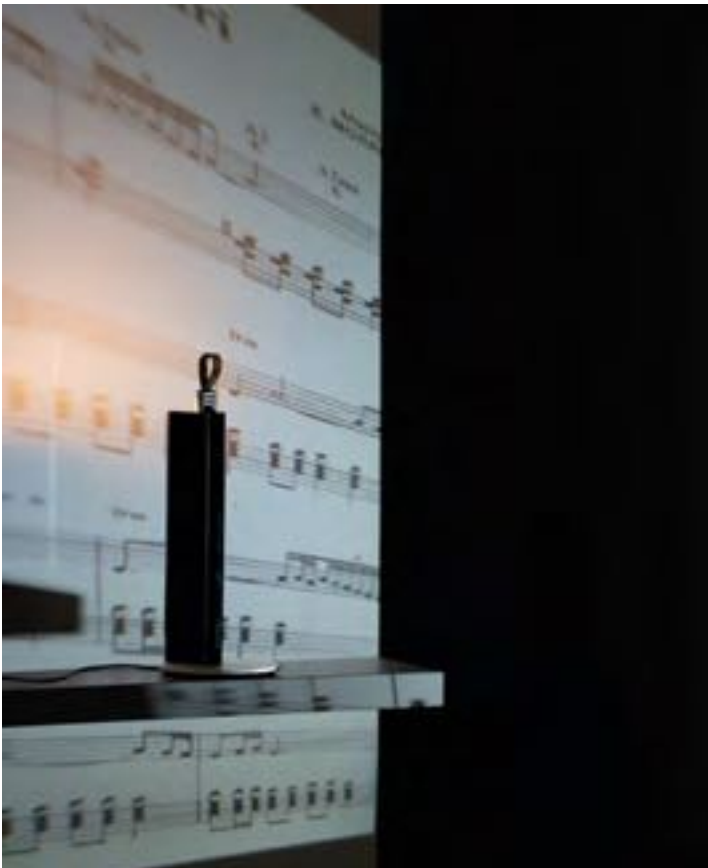





CABRIOLETTE

Piccola, orientabile, funzionale, rotonda e giocosa.

Il riflettore si orienta e si muove a ricordare una cabriolet.

Appoggiata sulla scrivania, in camera vicina al letto, da lettura vicino al divano, ma anche fuori nelle serate d'estate per illuminare il tuo party nella versione cordless.

Disponibile anche nella versione a parete e da terra.

Small, adjustable, functional, circular and playful.

The reflector swivels and moves to recall a cabriolet.

Placed on the desk, in the bedroom next to the bed, for reading next to the sofa, but also taken outside on summer evenings to light up your parties in the cordless version. Available in the wall and floor version.

STUDIO NATURAL

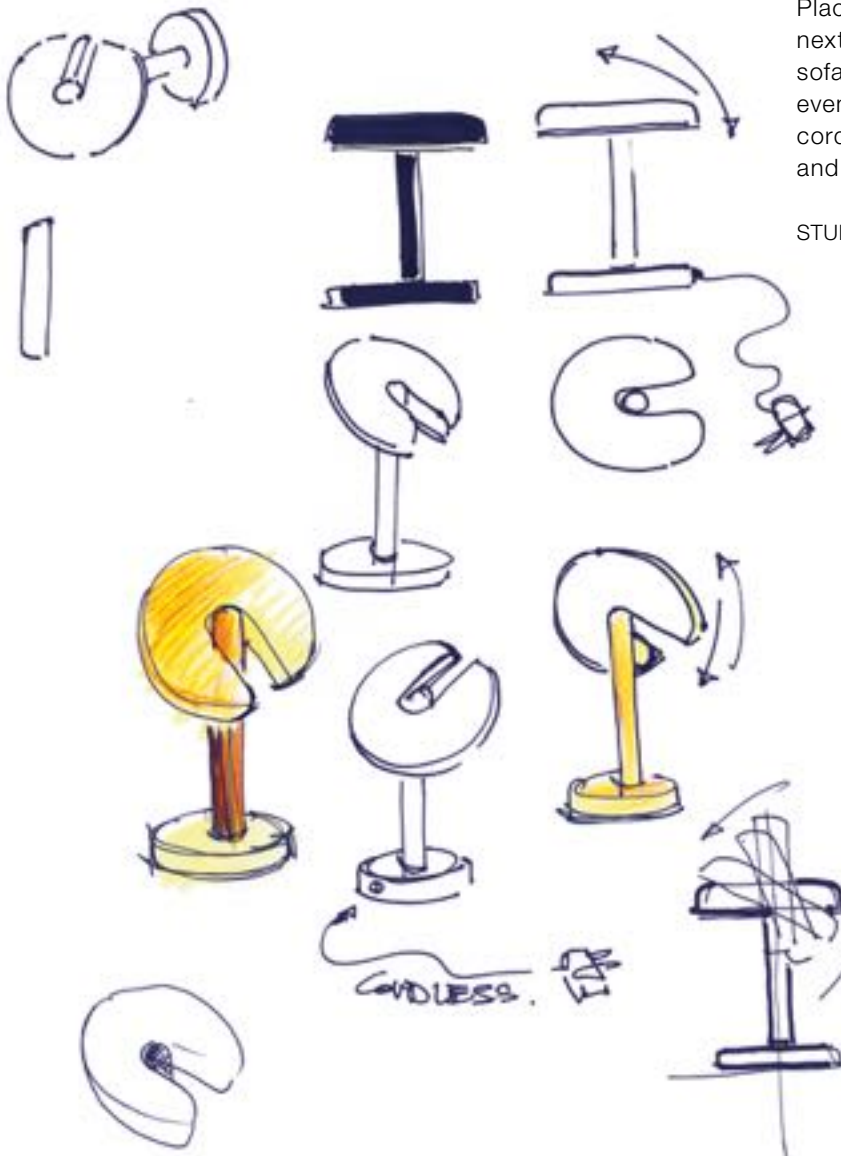

CABRIOLETTE

STUDIO NATURAL



Lampada da tavolo a luce diretta orientabile.
Struttura in pressofusione di alluminio verniciato nei colori bianco, nero, giallo e azzurro.
Diffusore in policarbonato opal bianco.
Sorgente di luce a LED integrato.
Dimmerabile con pulsante sul cavo.
Alimentatore a spina.

Table lamp providing direct adjustable light.
Aluminium die-cast structure painted in white, black, yellow and light blue.
White opal methacrylate diffuser.
Integrated LED light source.
Dimmable with button on cable.
Driver on the plug.

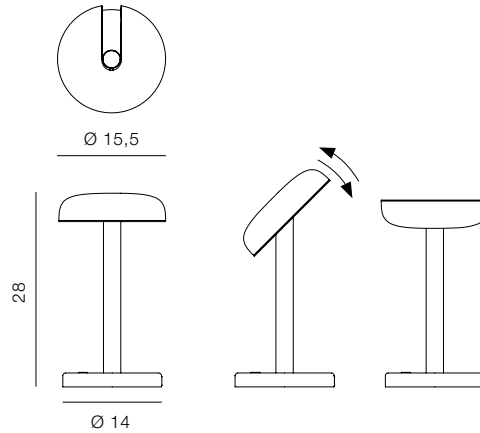

7,5W 1119lm 2700K

- 832/BI ○ bianco / white
- 832/NE ● nero / black
- 832/GI ● giallo / yellow
- 832/AZ ● azzurro / light blue



CABRIOLETTE cordless

STUDIO NATURAL



Lampada da tavolo cordless a luce diretta orientabile.

Struttura in pressofusione di alluminio verniciato nei colori bianco, nero, giallo e azzurro.

Sorgente di luce a LED integrato.

Dimmerabile con pulsante touch sulla base.

Batteria ricaricabile con cavetto USB-C incluso senza caricabatteria, durata 8 ore, batteria fornita.

Caricabatteria USB da ordinare a parte.

Cordless table lamp providing direct adjustable light.

Aluminium die-cast structure painted in white, black, yellow and light blue.

Integrated LED light source.

Dimmable with touch button on the base.

Rechargeable battery with USB-C cable included, duration 8 hours, battery supplied.

USB charger to be ordered separately.

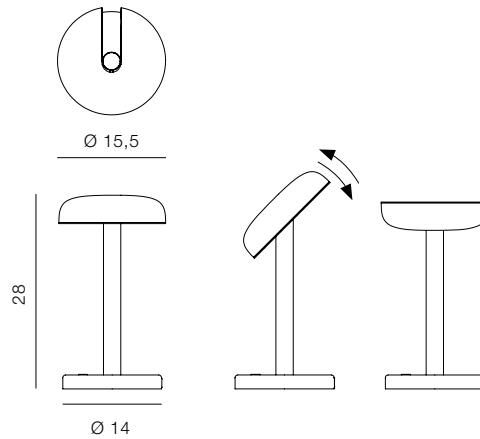

1,5W 220lm 2700K

832/CL/BI ○ bianco / white

832/CL/NE ● nero / black

832/CL/GI ● giallo / yellow

832/CL/AZ ● azzurro / light blue

40065 caricabatteria USB-C / USB-C charger







DELUX

Volevamo proporre un progetto a Martinelli Luce da presentare durante l'edizione Euroluce 2017. L'idea era quella di disegnare una lampada sospesa nel tempo in grado di essere inserita in qualsiasi ambiente. In quel periodo dopo pranzo in studio facevamo spesso delle lunghe partite a ping pong prima di rientrare al lavoro. Il tennis da tavolo è sempre stato uno scaccia pensieri e al tempo stesso tra uno scambio e l'altro parlavamo dei vari progetti in corso. L'argomento della lampada era sempre più ricorrente finché un giorno mettendo a fuoco le linee di una racchetta abbiamo iniziato a ridisegnarla giocando con le proporzioni. Un puro esercizio di stile che tratto dopo tratto ci ha fatto apparire una silhouette che sempre più ci convinceva. Un mix di richiami tra una racchetta da ping pong e una lampadina classica. L'utilizzo di materiali nobili come l'alluminio tornito e il marmo è stata una scelta spontanea dettata dalla geometria della lampada stessa. Per valorizzare maggiormente l'aspetto pulito abbiamo deciso di usare il vetro soffiato come diffusore. Da questa scelta deriva anche il nome Delux, un richiamo esplicito al valore dei materiali che delineano le geometrie morbide di un prodotto pensato per essere sospeso nel tempo.



We wanted to propose a project to Martinelli Luce to present during the Euroluce 2017 edition. The idea was to design a lamp suspended in time that could be placed in any environment. At that time, after lunch in the studio, we often played long games of table tennis before going back to work. Table tennis has always been a good way to get rid of our thoughts, and between exchanges we talked about various projects. We talked more and more about the lamp until one day, focusing on the lines of a racket, we started to redesign it by playing with the proportions. A pure exercise in style that, line by line, led to the appearance of a silhouette that was increasingly convincing. A mix of references between a table tennis racket and a classic light bulb. The use of noble materials such as turned aluminium and marble was a spontaneous choice dictated by the geometry of the lamp itself. To further enhance the clean look we decided to use blown glass as the diffuser. The name Delux also derives from this choice, an explicit reference to the value of the materials that outline the soft geometries of a product designed to be suspended in time.





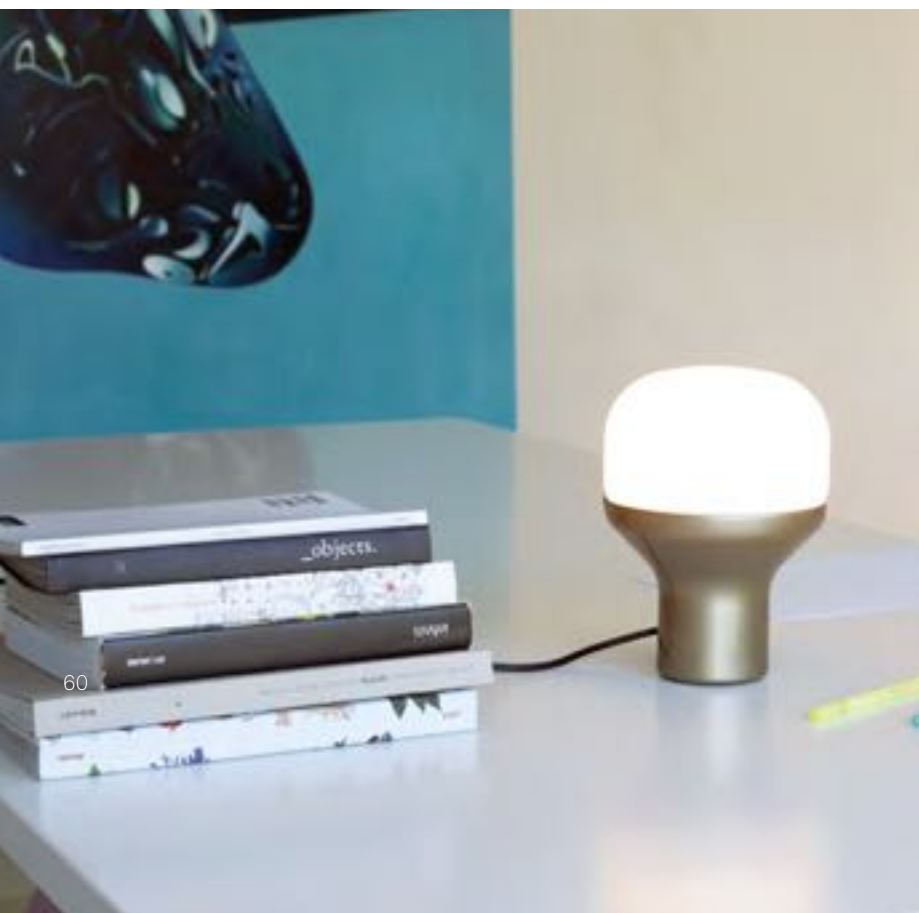



DELUX

STUDIO NATURAL



Lampada da tavolo a luce diffusa. Base in alluminio verniciato nel colore sabbia dorata, rame perlato o nero lucido. Diffusore in vetro soffiato opal bianco.
Per lampadina a LED.
Disponibile anche nella versione Junior e con base di marmo.

Table lamp with diffused light. Golden sand, pearly copper or glossy black painted aluminium base.
Blown opal white glass diffuser.
For LED bulb.
Available also in the Junior version and with marble base.

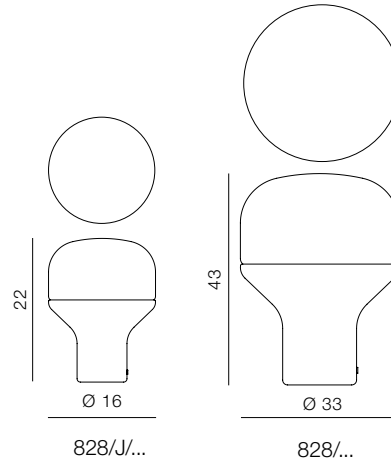

DELUX
1x10W E27 LED

- 828/CH ● sabbia dorata / golden sand
- 828/CP ● rame perlato / pearly copper
- 828/NE ● nero lucido / glossy black

DELUX JUNIOR
1x5W E14 LED

- 828/J/CH ● sabbia dorata / golden sand
- 828/J/CP ● rame perlato / pearly copper
- 828/J/NE ● nero lucido / glossy black



DELUX base in marmo / marble base



64

DELUX
1x10W E27 LED

828/MAR/MR ● marmo nero marquina
black marquina marble

828/MAR/CA ○ marmo bianco carrara
white Carrara marble

DELUX junior
1x5W E14 LED

828/J/MAR/MR ● marmo nero marquina
black marquina marble

828/J/MAR/CA ○ marmo bianco carrara
white Carrara marble







KIKI cordless

Kiki ha l'allegria e la bellezza leggera delle lanterne di carta cinesi.

Con un pizzico di ironia, tradizioni che appartengono a mondi lontani si contaminano e danno vita a luci da usare sia in giardino che all'interno della casa.

Kiki può avere tante vite sempre diverse e fantasiose sia nella versione singola che a catenaria.

(vedi catalogo architectural).

Kiki has the cheerfulness and light beauty of Chinese paper lanterns.

With a touch of irony, traditions that belong to distant worlds are contaminated and give life to lights that can be used both in the garden and inside the home.

Kiki can have many lives always different and imaginative, in both the single and chain versions .

(see architectural catalogue).

PAOLA NAVONE

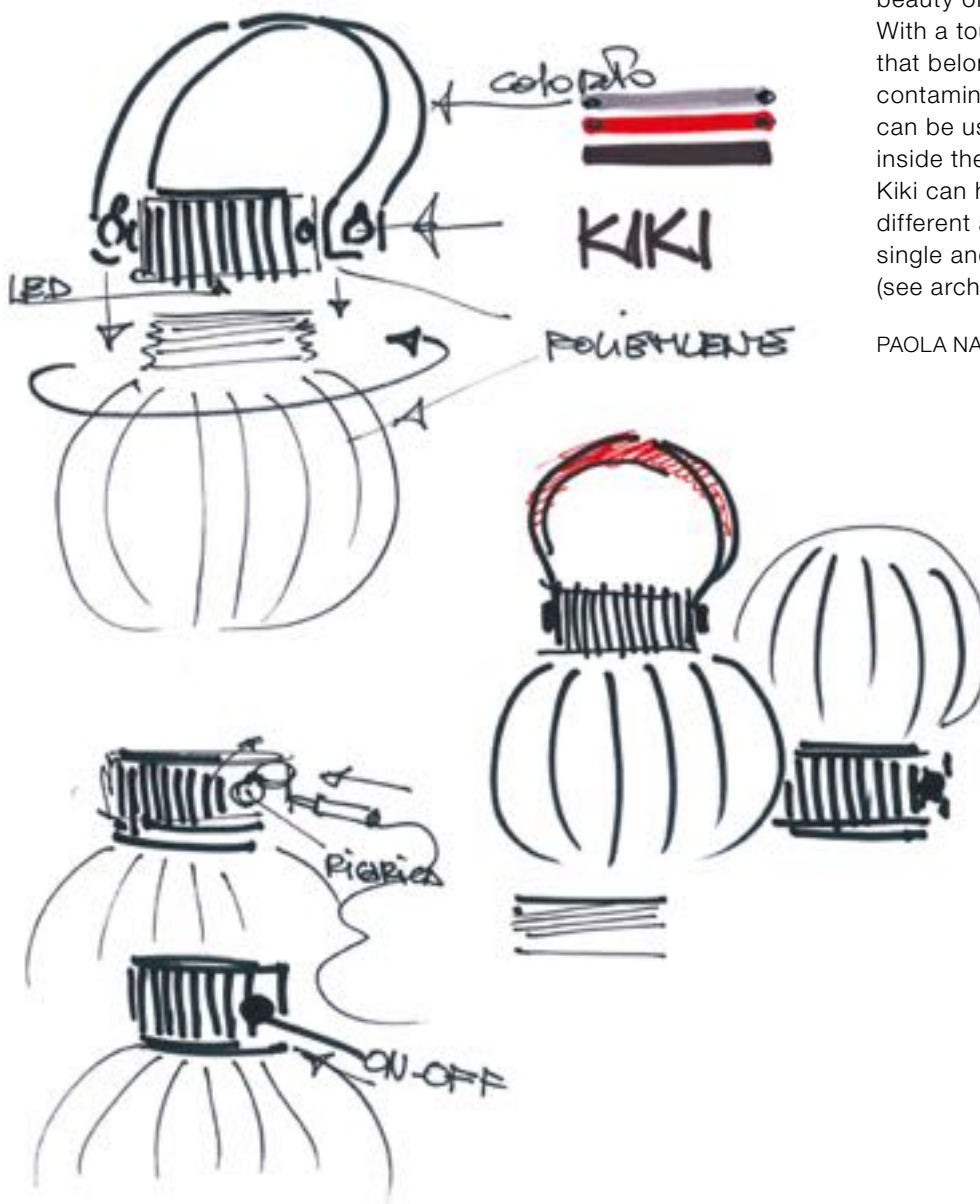

KIKI cordless

PAOLA NAVONE



Lampada dimmerabile a luce diffusa per esterno. Supporto stampato in resina e gomma per LED integrato. Diffusore in polietilene stampato in rotazionale, maniglia intercambiabile in silicone nei colori: rosso, nero, grigio-verde.
Batteria ricaricabile, con cavo USB, durata batteria 7 ore.
Caricabatteria USB da ordinare a parte.

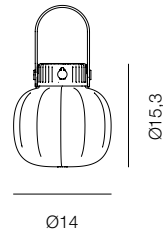

Diffused dimmable light lamp for outdoor. Molded support in resin and rubber for integrated LED. Diffuser in polyethylene, printed with rotational molding technology. Silicone interchangeable handle, provided in the following colours: red, black and grey-green.
Rechargeable battery, with USB cable, battery life 7 hours.
USB charger to be ordered separately.

1W LED 110lm 2700K

21004/DIM/CL/NE bianco / white

40065 caricabatteria USB / USB charger



La lampada è completa di maniglia intercambiabile in silicone nei colori rosso, nero o grigio-verde (includere)

The lamp is provided with interchangeable silicone handle in red, black, grey-green colour (included)





CYBORG

Mentre stavi sognando, Cyborg è atterrata sul tuo comodino avvolta da un fascio di luce. La piccola, intuitiva lampada reagisce al contatto umano grazie ai comandi tattili. Adoro il modo in cui essa sembra galleggiare sulla luce. Solo nell'era digitale abbiamo a disposizione nuove tecnologie, processi di produzione, materiali, software e strumenti che mi permettono di creare forme sensuali e naturali, come Cyborg.

While you were dreaming, Cyborg beamed down from above and landed on your bed side table. The small, friendly lamp responds to human contact thanks to touch-sensitive controls. I love the way it seems to float on the light. Only in the digital age we have new technologies, production processes, materials, software and tools allowing me to create sensual and organic shapes, like Cyborg.

KARIM RASHID

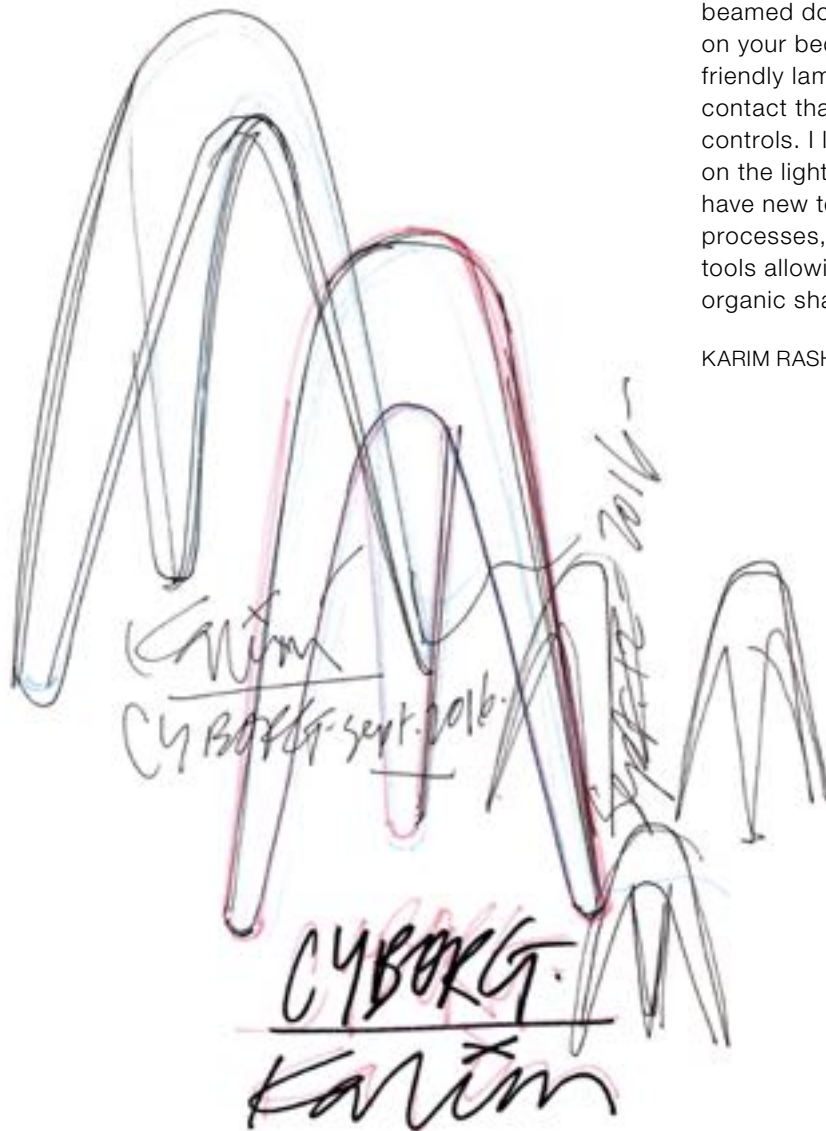

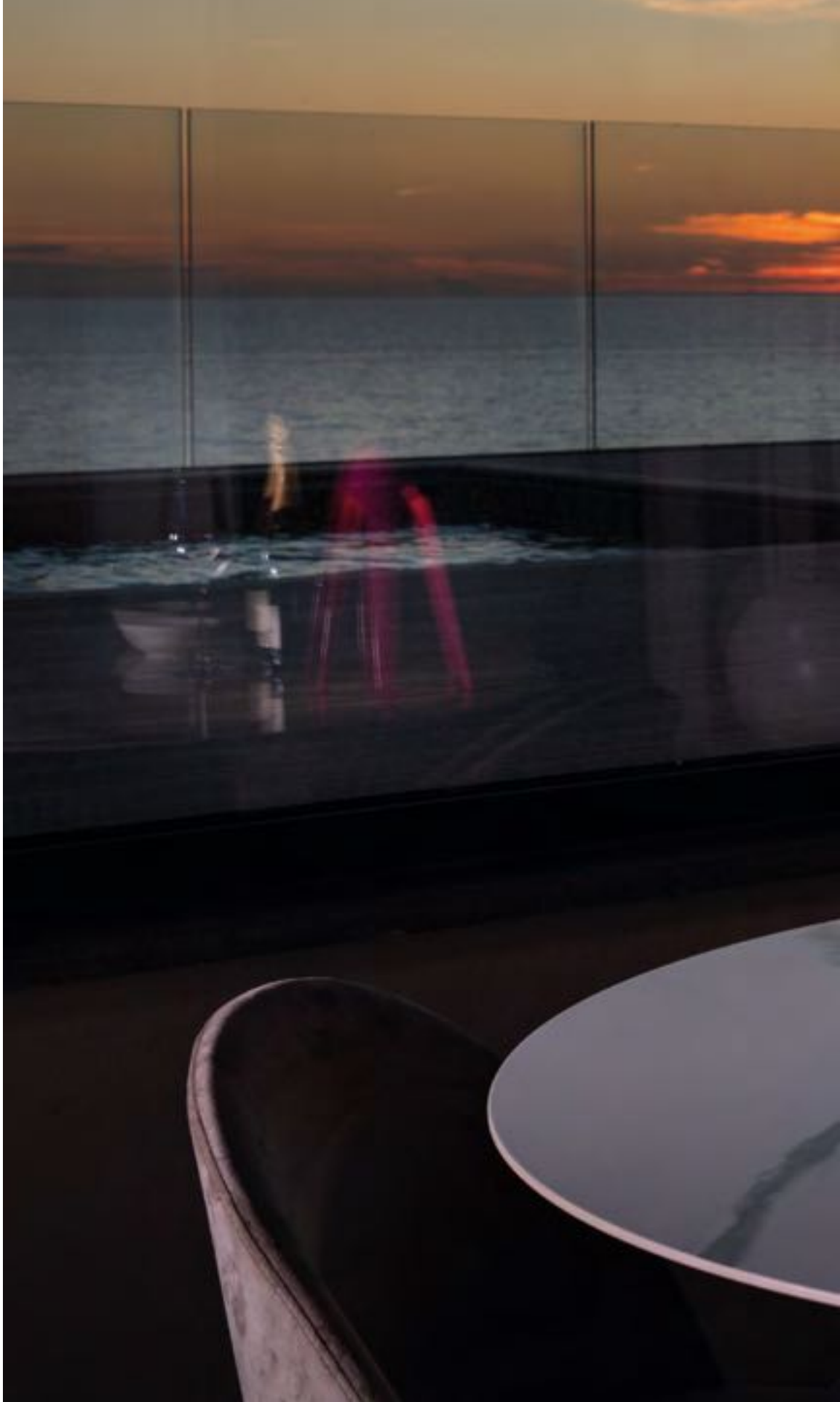







CYBORG

KARIM RASHID



Lampada da tavolo a luce diretta diffusa, struttura in fusione di alluminio verniciata nei colori bianco, azzurro chiaro, lime chiaro, grigio chiaro, fucsia e in alluminio naturale. Diffusore in policarbonato opal bianco. Sorgente di luce a LED integrato. Alimentatore elettronico a spina. Accensione e spegnimento on-off con sensore touch.

Table lamp direct diffused light. Structure of cast painted aluminium in colours white, light blue, light lime, light grey, fuchsia and natural aluminium colour. White opal polycarbonate diffusor. LED light source integrated, electronic driver on the plug. Sensor touch on-off.

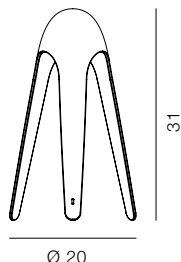

4,5W LED 450lm 3000K

- 825/BI ○ bianco / white
- 825/AZ ● azzurro chiaro / light blue
- 825/VE ● lime chiaro / light lime
- 825/GR ● grigio chiaro / light grey
- 825/AL ● alluminio naturale / natural aluminium
- 825/FC ● fucsia / fuchsia







HOOP

La funzione ne ha determinato la forma. Una lampada facile da accendere e spegnere anche durante la notte, dalla forma e proporzione che la riconducono quasi ad un oggetto ludico, seppur raffinata nei minimi dettagli. Un prodotto senza tempo e capace di adattarsi a stili e contesti d'uso differenti.

Function determined its form. A lamp that is easy to turn on and off, even during the night, with a shape and proportion that almost make it look like a playful object, yet refined in every detail. A timeless product capable of adapting to different styles and contexts of use.

ADOLINI & SIMONINI



Adolini

HOOP

ADOLINI & SIMONINI



Lampada da tavolo a luce diretta diffusa, struttura in resina nel colore bianco o nero. Diffusore in metacrilato opal bianco satinato. Sulla parte superiore del riflettore è presente un bottone di accensione touch, on/off. Sorgente di luce a LED. Alimentatore elettronico a spina.

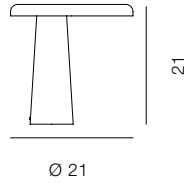

Table lamp direct diffused light. White or black resin structure. White opal satin methacrylate diffuser. Touch on/off button on the reflector. For LED light source. Electronic driver on the plug.

7W LED 650lm 3000K

824/BI ○ bianco / white

824/NE ● nero / black









MENTIONE D'ONORE

FLUIDA



Fluida è nata dal desiderio di creare una nuova lampada per la scrivania. L'ispirazione ci è arrivata un pomeriggio guardando un esercizio di ginnastica ritmica con il nastro. Tutto quel movimento, quei pivot, quell'energia ci hanno rimandato immediatamente ad un'idea di innata e indomabile flessibilità. Volevamo un prodotto che racchiudesse proprio questi valori, flessibilità e dinamicità; riuscire a sintetizzare tutto questo all'interno di un corpo luminoso non è stato affatto facile. L'applicazione dei LED ci ha aiutato a raggiungere il nostro obiettivo. Il primo prototipo che abbiamo realizzato non era altro che una fettuccia di materiale plastico con incollata una striscia LED. Volevamo un sistema semplice per giocare e interagire con la lampada, per questo l'utilizzo delle basi calamitate è stato perfetto. La sua ingegnerizzazione è stato uno dei processi più impegnativi realizzati insieme a Martinelli Luce. Ci sono voluti due anni di sviluppo per trovare un materiale che garantisse la flessibilità voluta mantenendo le performance luminose prefissate. Un processo lungo ma che ha dato vita ad un prodotto innovativo che a nostro avviso rispecchia pienamente il concetto di design Made in Italy, dove pensiero del progettista e conoscenza dell'imprenditore si uniscono in una stretta collaborazione per creare innovazione. La sua flessibilità le permette di adattarsi alle molteplici esigenze, dall'ambito lavorativo alla semplice illuminazione da tavolo. Il nome Fluida deriva dall'opera "Strutturazione Fluida" dell'artista futurista Gianni Colombo.

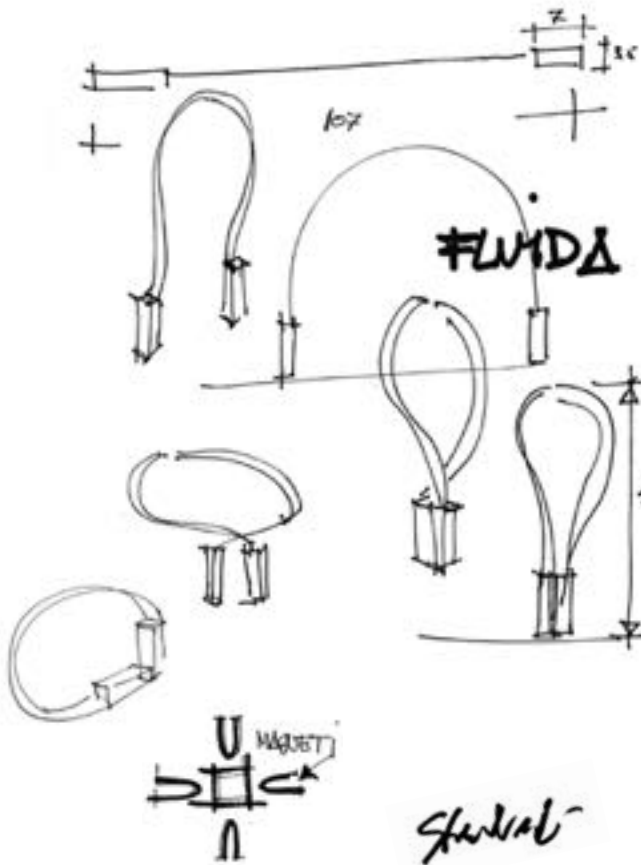

Fluida was born from the desire to create a new desk lamp. Inspiration came to us one afternoon while watching a rhythmic gymnastics exercise with the ribbon. All that movement, those pivots, that energy immediately reminded us of an idea of innate and indomitable flexibility. We wanted a product that reflected these values, flexibility and dynamism. It was not easy to combine all this in a light body. The application of LEDs helped us to achieve our goal. The first prototype we made was a simple plastic strip with a LED strip glued to it. We wanted a simple way to play and interact with the lamp, so the use of magnetic bases was perfect. Its engineering was one of the most challenging processes carried out together with Martinelli Luce. It took two years of development to find a material that would provide the desired flexibility while maintaining the desired lighting performance. A long process, but one that has given rise to an innovative product which, in our opinion, fully reflects the concept of Made in Italy design, where the designer's thoughts and the entrepreneur's knowledge come together in close collaboration to create innovation. Its flexibility allows it to adapt to a wide range of needs, from the working environment to simple table lighting. The name Fluida comes from the work "Strutturazione Fluida" by the futurist artist "Gianni Colombo."

STUDIO NATURAL





Abitazione privata, Tavernelle Val di Pesa, Aoa Architetti

FLUIDA

STUDIO NATURAL



Lampada da tavolo a luce diretta formata da una fascia flessibile con sorgente di luce a LED unita alle due basi in resina. Le due basi, grazie ai magneti al loro interno, si uniscono in molteplici posizioni modificando l'orientamento della fascia LED, creando ogni volta performance luminose diverse. Alimentatore elettronico a spina.

Table lamp indirect light formed by a flexible strip with LED light source connected to the two resin bases. The two bases, thanks to the magnets inside them, can be joined in multiple positions modifying the direction of the strip LED creating every time different light performances. Electronic driver on the plug.

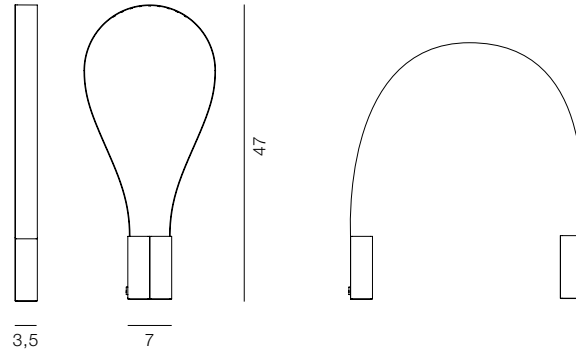

4W LED 400lm 3000K

823/BI ○ bianco / white



MENZIONE D'ONORE
COMPASSO D'ORO 2016



1° PREMIO YOUNG & DESIGN 2013



ADI DESIGN INDEX





PULCE

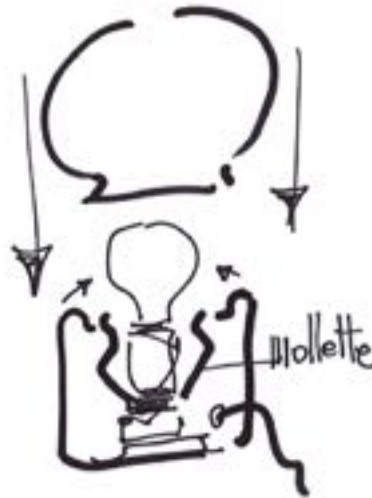

PULCE

Il mio hobby è la pittura, dipingo la sera, è per me un relax.

Avevo vicino una lampada con un diffusore in vetro che faceva però troppa luce disturbando i miei colori. Ho dato così delle veloci pennellate di blu per oscurare il vetro.

È nata così l'idea di base per Pulce. Una piccola lampada con una luce intensa da un lato e una luce soft dall'altro.

My hobby is painting, I paint in the evening, it's relaxing for me.

I had a lamp with a glass diffuser next to me, but it was too bright and disturbed my colours. So I gave quick strokes of blue to darken the glass.

The basic idea for Pulce was born.

A small lamp with an intense light on one side and a soft light on the other.

EMILIANA MARTINELLI

PULCE

EMILIANA MARTINELLI



Lampada da tavolo a luce diffusa.
Diffusore in vetro soffiato opal bianco.
Base in alluminio verniciato nel colore blu
o giallo senape con pennellata nello stesso
colore. Con base bianca o in ottone satinato
con vetro opal bianco. Lampadina a LED.

Table lamp providing diffused light.
White opal blown glass diffuser.
Aluminium base painted in blue or mustard
yellow with brushstroke in the same colour.
With white or satin brass base with white
opal glass. LED bulb.

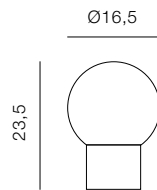

1x5W E27 LED

820/BI  bianco / white

820/BL  blu / blue

820/GI  giallo / yellow

820/OT  ottone / brass

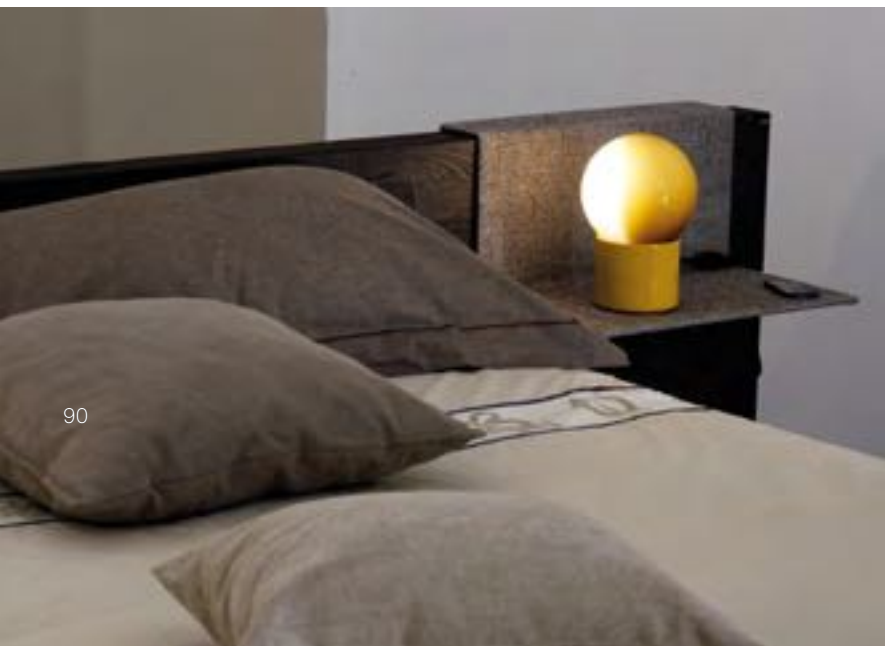



Casa privata Ciciana, Lucca



SEGNALIBRO

Vicino al mio letto avevo un tavolino molto piccolo, ci doveva stare una lampada, il telefono, un blocchetto per gli appunti, frutta secca da mangiare davanti alla tv, ma anche un libro per quando la televisione diventava noiosa. Quindi mancando lo spazio ho pensato di poter riporre il libro sopra la lampada, aperto all'ultima pagina letta prima che il sonno avesse il sopravvento. Una lampada che cambia aspetto a secondo della tua lettura; la copertina colorata o solo grafica ne determina la metamorfosi. La lampada diventa "segnalibro", il libro diventa "paralume" e parte integrante della lampada stessa.

Next to my bed I had a very small table on which a lamp was supposed to be placed, or a telephone, a notepad, dried fruit to eat in front of the TV, but also a book for when the TV became boring. So, since there was no space, I thought I could put the book on top of the lamp, opened to the last page read before sleep took over me.

A lamp that changes appearance depending on your reading; the coloured cover or only graphics determine its metamorphosis. The lamp becomes "bookmark", the book becomes "lampshade" and integral part of the lamp itself.

ORLANDINI DESIGN

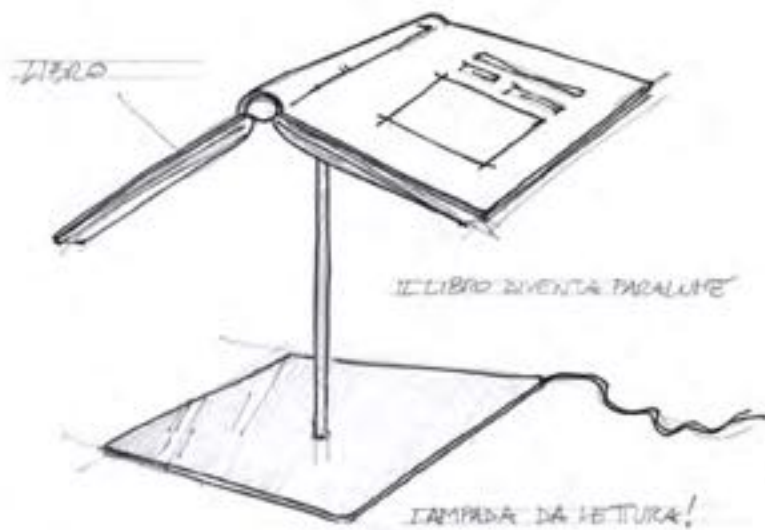
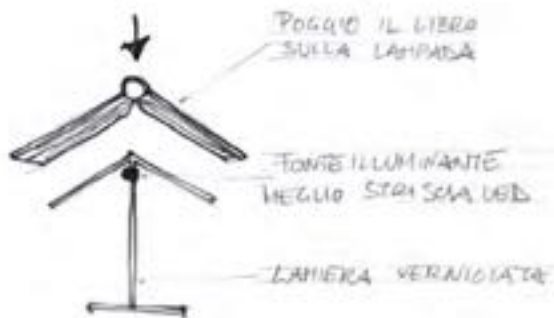

SEGNALIBRO

ORLANDINI DESIGN



Lampada da lettura a luce diretta in metallo verniciato nel colore bianco. La lampada diventa "segnalibro", il libro diventa paralume e parte integrante della lampada stessa, la luce e il libro entrano in stretta simbiosi. La lampada quasi scompare ed è il libro a diventare il tema estetico-decorativo del prodotto. Sorgente di luce a LED. Alimentatore elettronico a spina.

Reading, table lamp, direct light, white painted metal. The lamp becomes a "bookmark", the book becomes lampshade and integral part of the lamp, the light and the book come in close symbiosis. The lamp almost disappears and the book becomes the aesthetic-decorative theme of the product. LED light source. Electronic driver on the plug.

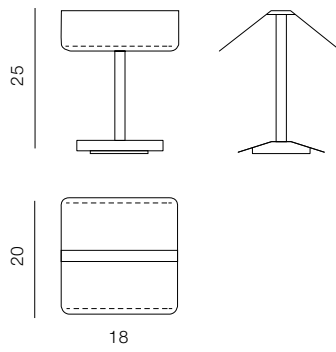

6W 600lm 3000K

817/BI ○ bianco / white







COLIBRÌ

Un segno grafico minimale che esalta la funzione. La testa orientabile nasconde la sorgente di luce a LED e illumina con una luce diretta il tavolo da lavoro e la tua lettura senza abbagliarti.

A minimalist graphic sign that enhances function. The swivelling head conceals the LED light source and provides direct light for your work table and reading without dazzling you.

EMILIANA MARTINELLI



COLIBRÌ

EMILIANA MARTINELLI



Lampada da tavolo a luce diretta orientabile.
Struttura in alluminio verniciato nero.
Testa girevole per sorgente di luce a LED.
Base in metallo verniciato nel colore nero.
Alimentatore elettronico a spina.
Con sensore touch.

Adjustable table lamp direct light. Black
painted aluminium structure. Swivel head
whit LED light source. Black colour painted
metal base. Electronic driver on the plug.
With touch control.

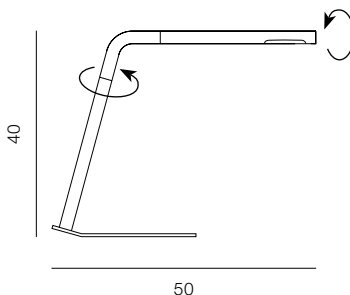

10W 800lm 3000K

811/T/H/NE ● nero / black





Casa Poggio Terralba, Pisa





ELICA

L'ispirazione nasce dall'intento di progettare una lampada da tavolo a LED, dove il LED fosse l'unica fonte luminosa con la quale potesse essere realizzata. Il mio interesse nel LED era concentrato principalmente nella sua forma e nella sua proporzione, unica nel suo genere: lunga, stretta e piatta, quindi non assimilabile ad altre fonti luminose ad esempio puntiformi o con spessori importanti. Lo spessore del braccio di Elica infatti è stato dimensionato in funzione dei LED ed il braccio è stato il punto di partenza del progetto: 8mm è lo spessore minimo che garantisce l'alloggiamento dei LED e la resistenza alla flessione. Dato lo spessore del braccio bisognava definirne la forma, conferendo una rotondità finale al braccio che è figlia della rotazione. Come raccordare quindi un cerchio ad un altro cerchio più grande in modo da rendere la base stabile? Con un segmento dritto. Si ottiene quindi un cono. L'altezza della lampada e lunghezza del braccio sono dimensionati secondo i principi della sezione aurea e non è presente nessun dettaglio tecnico a vista: il braccio stesso della lampada costituisce l'interruttore. Ruotando il braccio, la lampada si accende e si spegne, generando un effetto sorpresa. Inoltre l'accensione/spegnimento della lampada è accompagnato da un effetto sonoro, un click che costituisce un ulteriore feed-back per l'utente e contemporaneamente un richiamo al suono dei classici interruttori. L'ispirazione fin qui descritta era inoltre accompagnata da un preciso intento: non volevo progettare una lampada molto "tecnica" o un prodotto di styling, desideravo invece che potesse durare nel tempo. Pertanto mi sono ispirato alle forme pure delle grandi lampade del passato, come Atollo, Eclisse, Cobra. L'obiettivo dichiarato era creare una lampada senza tempo.

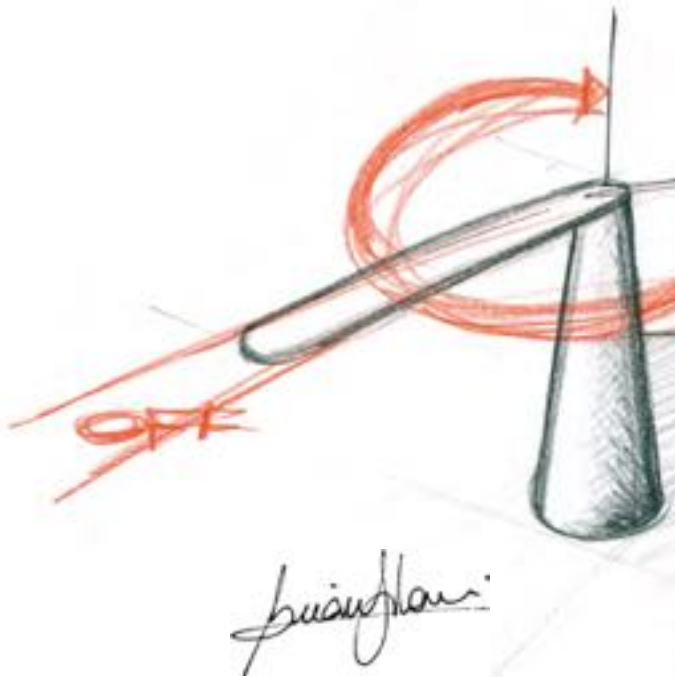

The inspiration came from the intention to design a LED table lamp, where the LED was the only light source with which it could be made. My interest in the LED was mainly concentrated in its shape and proportion, which is unique: long, narrow and flat, so it cannot be assimilated to other light sources such as point or thick ones. In fact, the thickness of Elica's arm was dimensioned according to the LEDs and the arm was the starting point of the project: 8mm is the minimum thickness that guarantees the housing of the LEDs and resistance to bending. Given the thickness of the arm, it was necessary to define its shape, giving a final roundness to the arm that is the result of rotation. So how do you join one circle to another larger circle to make the base stable? With a straight segment. The result is a cone. The height of the lamp and the length of the arm are dimensioned according to the principles of the golden section and there is no visible technical detail: the arm of the lamp itself is the switch. By rotating the arm, the lamp turns on and off, generating a surprise effect. In addition, the switching on/off of the lamp is accompanied by a sound effect, a click that provides additional feedback for the user and at the same time recalls the sound of classic switches. The inspiration described above was also accompanied by a precise intention: I didn't want to design a very "technical" lamp or a styling product, I wanted it to be long-lasting. Therefore I was inspired by the pure shapes of the great lamps of the past, such as Atollo, Eclisse, Cobra. The stated aim was to create a timeless lamp.





ELICA

BRIAN SIRONI



Lampada da tavolo a luce diretta girevole.
Struttura in alluminio verniciato.
Sorgente di luce a LED integrato.
Alimentatore elettronico sulla spina.
L'accensione e lo spegnimento della lampada avviene tramite la rotazione del braccio.

Table lamp with an adjustable direct light.
Painted aluminium structure. LED light source integrated. Electronic driver on the plug. The lamp lights up and switch off by the rotation of its arm.

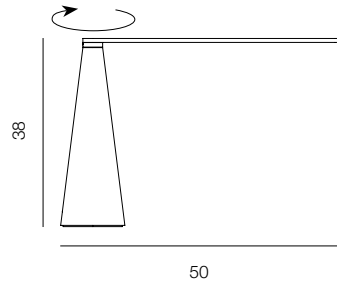

9W LED 720lm 3000K

807/J/BI ○ bianco / white

807/J/NE ● nero / black

807/J/GI ● giallo / yellow



104



AWARDS:
-YOUNG&DESIGN 2009
-HONORABLE MENTION I.D.
-ANNUAL DESIGN REVIEW 2010
-IF GOLD AWARD 2010
-GOOD DESIGN AWARD 2010
-GERMAN DESIGNPREIS NOMINEE 2011
-RED DOT DESIGN AWARD 2011
-XXII COMPASSO D'ORO - ADI" 2011



CIVETTA

EMILIANA MARTINELLI



Lampada da tavolo a luce indiretta e diffusa. Struttura in tubolare di alluminio, verniciato nel colore bianco. Disco diffusore superiore in metacrilato satinato nel colore bianco o arancio.

Table lamp, diffused and indirect light. Tubular aluminium structure in white painted colour. Upper satin methacrylate finish diffuser in white or orange colour.

1x5,3W E27 LED

804/BI/BI bianco-bianco / white-white

804/BI/AR bianco-arancio / white-orange

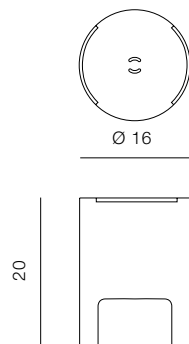

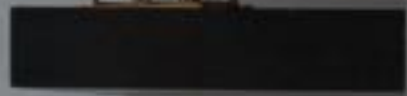



TX1

Amo molto la tecnologia e l'informatica. Inoltre, lo spazio celeste mi ha sempre affascinato per essere senza confini e barriere e mi sono sempre emozionato a vedere le strutture dei satelliti nello spazio, lucidissime e piene di antenne radio e pannelli solari. La Tx1 è la mia prima lampada e l'ho disegnata con l'intento di fare un prodotto che esprimesse le mie emozioni, versatile, caratterizzato dall'emettere una luce indiretta e orientabile (la luce può essere riflessa per 30° max in due direzioni). Mi sono ispirato ad un radar che si orienta verso lo spazio per comunicare con i satelliti e il nome che le ho dato deriva dal codice di un satellite. L'idea di partenza è stata quella di un riflettore lucidato a specchio su cui incidesse la forte luminosità data da lampadine dicromatiche colorate RGB (red-green-blue) inserite all'interno di un corpo tubolare in alluminio, in modo da poter creare qualunque tipo di colore sfruttando un comando remoto. Quando la lampada è nata non era ancora disponibile la tecnologia LED, adottata poi nel 2009 (due anni dopo la prima versione). A questo primo aggiornamento tecnologico importante fa seguito l'introduzione della tecnologia bluetooth che consente di comandare la sorgente luminosa utilizzando una APP per smartphone o tablet e ottenere tramite la nuova tecnologia "tunable white" una luce calda o fredda in base alle proprie esigenze, oltre alle mille diverse colorazioni che la tecnologia LED già consentiva. La lampada per le sue dimensioni e le caratteristiche illuminotecniche è ideale per essere utilizzata nel soggiorno, su un tavolo basso vicino al divano.

I really love technology and informatics. In addition, celestial space has always fascinated me because it has no boundaries or barriers, and I have always been excited to see the structures of satellites in space, very shiny and full of radio antennas and solar panels. The Tx1 is my first lamp and I designed it with the intention of making a product that would express my emotions, be versatile, emit indirect light and be adjustable (the light can be reflected for 30° max in two directions). I was inspired by a radar that orients itself towards space to communicate with satellites, and the name I gave it derives from the code of a satellite. The starting idea was a mirror-polished reflector on which the strong luminosity given by RGB (red-green-blue) coloured dichroic bulbs inserted inside a tubular aluminium body would affect, so that any type of colour could be created using a remote control. When the lamp was created, LED technology was not yet available, which was adopted in 2009 (two years after the first version). This first important technological update was followed in recent days by the introduction of Bluetooth technology, which allows the light source to be controlled using an APP for smartphones or tablets and to obtain, through the new "tunable white" technology, a warm or cold light according to one's needs, in addition to the thousands of different colours that LED technology already allowed. The lamp's size and lighting characteristics make it ideal for use in the living room, on a low table near the sofa.

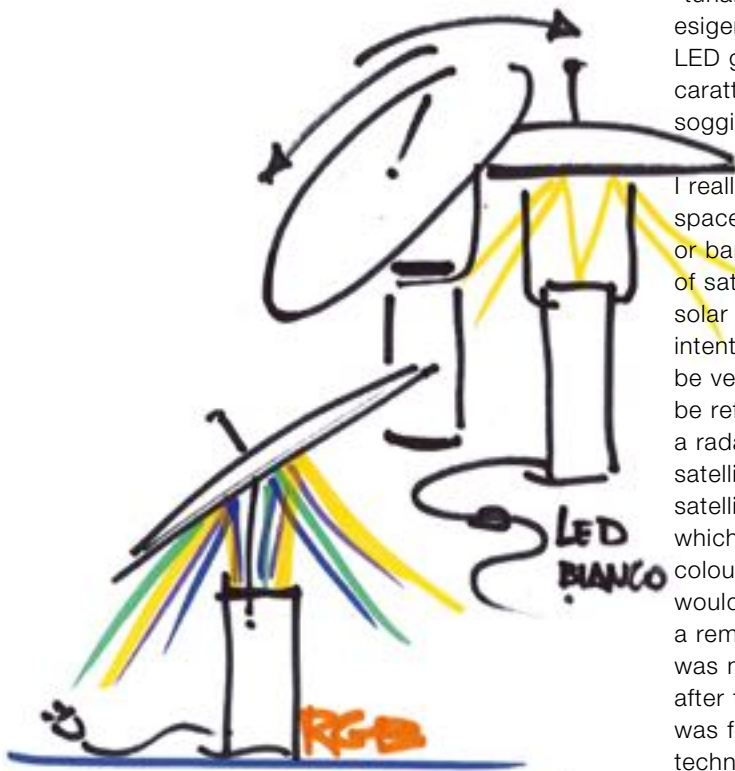









TX1 tech

MARCO GHILARDUCCI



LIGHTYOU LIKE

Lampada da tavolo a luce riflessa, riflettore orientabile, corpo in alluminio verniciato bianco e supporti cromati. Lampada dimmerabile Bluetooth con APP Casambi nelle versioni con sorgente di luce a LED tunable white e RGB.

Sorgente di luce a LED integrato. Alimentatore elettronico a spina.

Table lamp with reflected light, adjustable reflector, white painted aluminium body, chromed supports. Bluetooth dimmable lamp with Casambi APP in versions with tunable white and RGB LED light source.

LED light source integrated. Electronic driver on the plug.

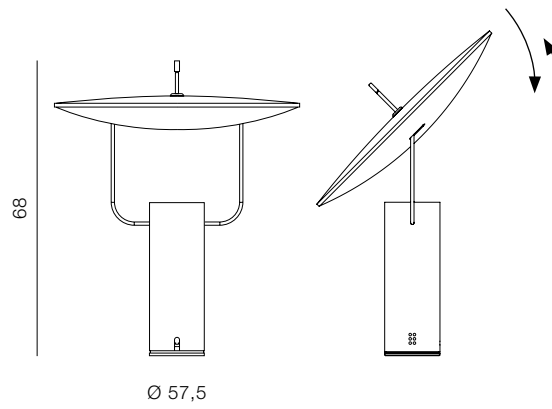

 TUNABLE WHITE
32W LED 3100lm 2500-6700K

799/L/1/BD/BI bianco / white

 RGB
18W LED RGB 1800lm

799/L/BD/BI bianco / white

 CASAMBI App iOS / Android - Free -





TX1 luxury

MARCO GHILARDUCCI



Lampada da tavolo a luce riflessa, riflettore orientabile, corpo in alluminio verniciato. Versione con LED bianco e interruttore sul cavo, verniciata nel colore grigio con supporti in ottone satinato (disponibile in due dimensioni). Sorgente di luce a LED integrato. Alimentatore elettronico a spina. Dimmerabile con pulsante sul cavo.

Table lamp with reflected light, adjustable reflector, painted aluminium body. Version with white LED and switch on the cable is painted in grey with satin brass supports (available in two sizes). LED light source integrated. Electronic driver on the plug. Dimmable with switch on cable.

TX1
27,5W LED 3000lm 3000K

799/DIM/L/1/GR ● grigio / grey

TX1 medio
9W LED 1120lm 3000K

799/MED/DIM/L/1/GR ● grigio / grey

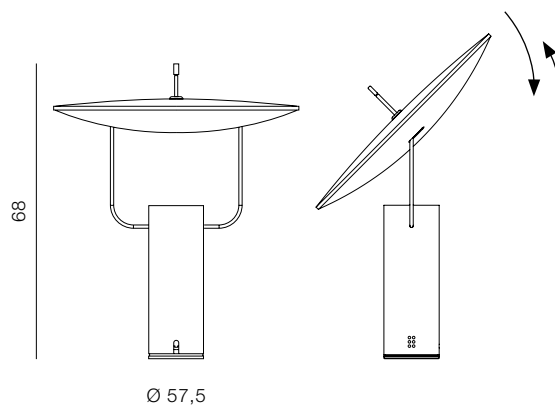

799/DIM/L/1/GR

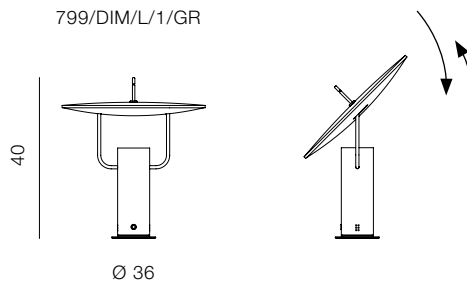

799/MED/DIM/L/1/GR







MICO

Un progetto solo apparentemente semplice confermato con Elio Martinelli - la rivisitazione di un pezzo classico della collezione - il diffusore in termoplastico opalino con il bordo in sottosquadro - impreziosito da un disco sottostante trasparente che si riflette in forma anamorfica sul piede metallico, in una sorta di suggestivo gioco di riflessioni.

An only apparently simple project co-signed with Elio Martinelli - the reinterpretation of a classic piece of the collection - the opal thermoplastic diffuser with an undercut edge - enhanced by a transparent underlying disc that is reflected in an anamorphic shape on the metal base, in a sort of suggestive play of reflections.

ELIO MARTINELLI - MARC SADLER

REFLECTS.

Cassa sotto lampada (ELIO M)

"MICO"

R=3/4

SADLER

MICO

ELIO MARTINELLI - MARC SADLER



Lampada da tavolo a luce diffusa. Struttura in metallo verniciato nero lucido, diffusore in metacrilato opal bianco, con disco diffusore inferiore in metacrilato satinato nel colore bianco.

Lampadina LED.

Table lamp diffused light. Structure in glossy black painted metal, white opal methacrylate diffuser, with lower diffuser in white colour sanded methacrylate.

LED bulb.

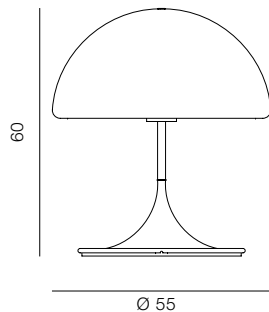

1x12W E27 LED

793/NE/BI  nero-bianco / black-white



Su richiesta il disco inferiore in altri colori.
Lower disc in other colours on request.





L'AMICA

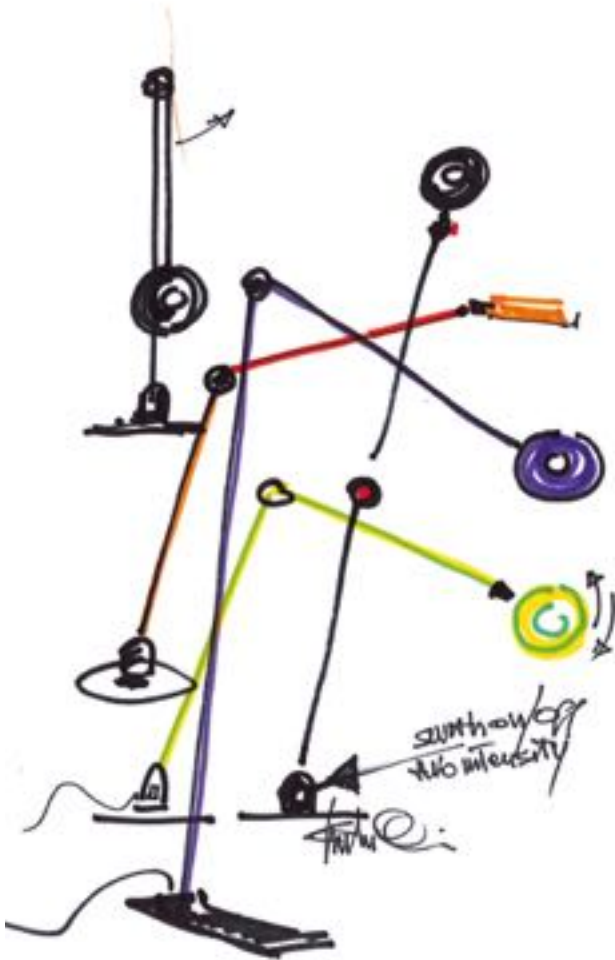

Esile, ma di grande impatto visivo, orientabile, semplice, utilissima, direi anche allegra per i suoi colori, il verde pistacchio, il grigio e il nero con gli snodi blu, grigio o corallo. Amica può essere la tua compagna nel lavoro quotidiano o nei momenti di svago e di lettura. Divertente, nelle sue varianti realizzate in occasione di alcune presentazioni all'estero, si è vestita dei colori della bandiera italiana, francese, tedesca, cinese, ed è stata anche personalizzata con delle varianti pop. Amica è nata nel 2012, come evoluzione della lampada l'Amico. Il diffusore era diverso, una mezza sfera in vetro colorato diffondeva la luce di una lampadina ad alogeni. Il nome nacque all'improvviso, mentre eravamo intorno al tavolo rotondo delle prove, mio padre, mia madre, il tecnico ed io, per verificare il prototipo, i suoi movimenti, la sua funzionalità. L'architetto Paolo Riani, un carissimo amico, anche lui presente, vedendo le varie possibilità di utilizzo della lampada, esclamò "ma questo è un vero amico", e così si chiamò. Oggi l'Amica ha "messo la testa a posto", un diffusore a forma di anello supporta un circuito a LED studiato appositamente e permette, come una maniglia, di orientare il braccio e la luce nella direzione giusta.

Quindi, puoi appoggiarla non solo sul tavolo da lavoro o sulla scrivania, ma attento... anche sul comodino per illuminare le pagine del tuo libro e leggere senza dare fastidio a chi è con te nel letto. Amica è disponibile anche in una nuova versione da terra per una piacevole lettura seduto sul divano o in poltrona, facendoti sentire in buona compagnia.

Slim, but of great visual impact, adjustable, simple, very useful, I would even say cheerful for its colours, pistachio green, grey and black with blue, grey or coral joints. Amica can be your companion in your daily work or in moments of amusement and reading. Funny, in its variants made for some presentations abroad, it was dressed in the colours of the Italian, French, German and Chinese flags, and was also customised with pop variants. Amica was born in 2012, as an evolution of the l'Amico lamp. The diffuser was different, a half sphere of coloured glass diffusing the light of a halogen bulb. The name was born suddenly while we were gathered at our round rehearsal table, my father, my mother, the technician and I, testing the prototype, its movements, its functionality. The Architect Paolo Riani, a very dear friend, who was also present, saw the various possibilities of using the lamp, exclaimed "but this is a real amico ("friend" in Italian language)", and so it was called. Today the Amica has "put its head on straight", a ring-shaped diffuser supports a specially designed LED circuit and allows, like a handle, the arm and light to be directed in the right direction. So, you can place it not only on your work table or desk, but watch out... also on your bedside table to illuminate the pages of your book and read without bothering those with you in bed. Amica is also available in a new floor-standing version for pleasant reading while sitting on the sofa or in an armchair, making you feel like you are in good company.

ELIO & EMILIANA MARTINELLI





L'AMICA

ELIO E EMILIANA MARTINELLI



Lampada da tavolo a luce diretta. Braccio articolato in metallo e testa orientabile in alluminio, verniciato nel colore verde pistacchio, nero lucido o grigio. Snodi stampati in resina nel colore nero, pomelli nel colore blu, corallo o grigio. Base in metallo nel colore nero. Interruttore a doppia intensità di luce, inserito nel supporto del braccio. Sorgente di luce a LED integrato. Alimentatore elettronico sulla spina.

Table lamp diffused and direct light. Swivel arm with adjustable aluminium head, painted in pistachio green, glossy black or grey. Moulded resin joints in black, knobs in blue, coral or grey. Metal base in black colour. Switch for double light intensity inside the arm. LED light source integrated. Electronic driver on the plug.

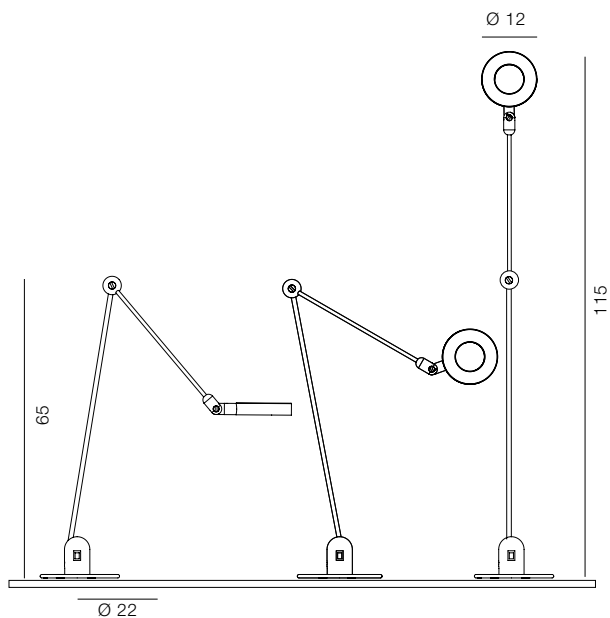

9W LED 900lm 3000K

736/L/VE ● verde pistacchio - pomello blu
pistachio green - blue knob

736/L/NE ● nero lucido - pomello corallo
glossy black - coral knob

736/L/GR ● grigio - pomello grigio
grey - grey knob







ELMETTO

Il nome ne identifica subito la forma, ce lo immagineremmo così anche se invisibile. È una piccola lampada da tavolo ideale compagna della sera, sopra la mensola accanto al letto, vicino al divano o dove vuoi un po' di luce per leggere. Un punto di luce, di colore e di design nel tuo mondo.

Its name immediately identifies its shape, we could imagine it even though it was invisible. It is a small table lamp, the ideal mate for the evening, on a shelf near your bed, near the sofa wherever you want to have a little bit of light or wherever you want to read. A point of light, a shade and a hint of design into your world.

ELIO MARTINELLI



Martinelli

ELMETTO

ELIO MARTINELLI



Lampada da tavolo a luce diretta. Base e riflettore orientabile con schermo interno in alluminio verniciato nel colore bianco. Struttura stampata in resina. Colori bianco, giallo, nero, blu, arancio, verde, dorato e rosso rubino.

Table lamp with direct light. Adjustable reflector with inside screen made of aluminium painted in white. Structure made of resin. Colours white, yellow, black, blue, orange, green, golden and ruby red.

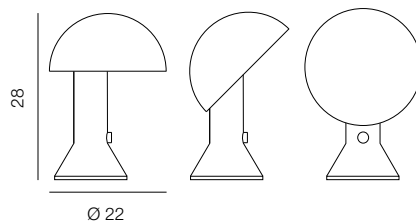

1x5W E27 LED

- 685/BI ○ bianco / white
- 685/GI ● giallo / yellow
- 685/NE ● nero / black
- 685/BL ● blu / blue
- 685/AR ● arancio / orange
- 685/VE ● verde / green
- 685/AU ● dorato / golden
- 685/RO ● rosso rubino / ruby red





La casa Fluida mostra di Elle Decor, Fuorisalone-Milano 2021



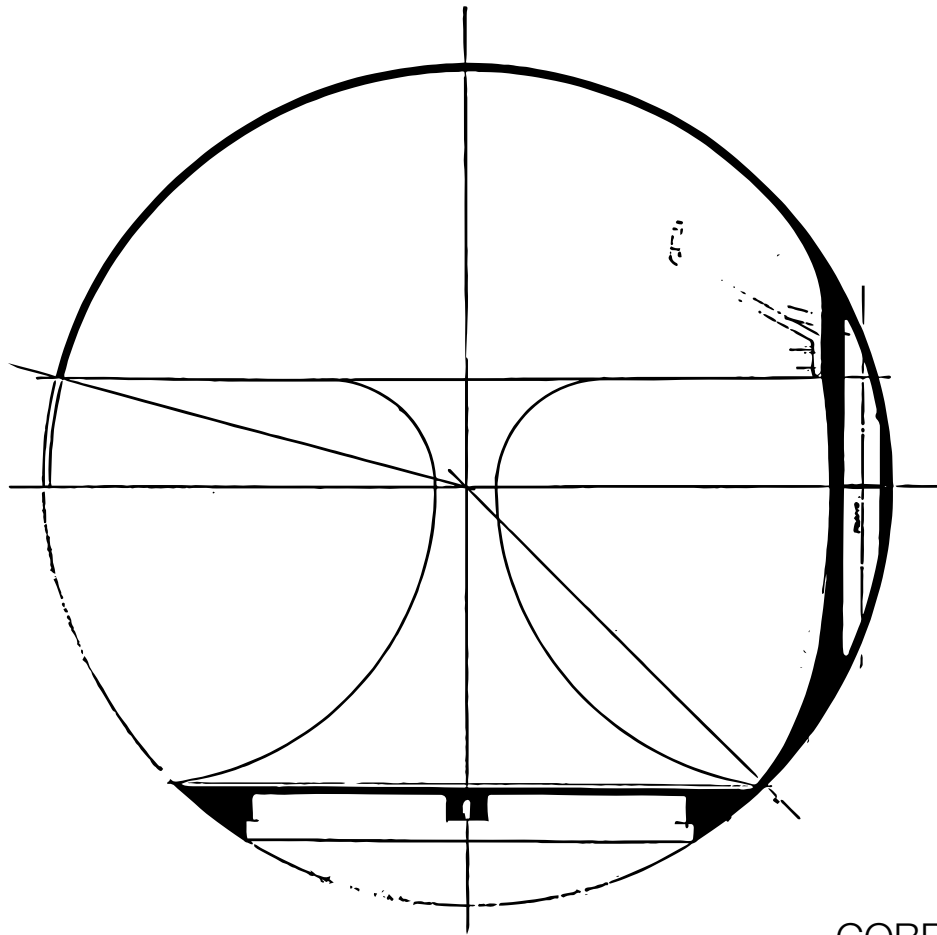

Martiniello

COBRA

La lampada è racchiusa in una sfera, due piani orizzontali dividono il riflettore dalla base.

Il movimento rotatorio del riflettore intorno allo snodo centrale va a descrivere sempre nuove sfere.

Una forma sinuosa dinamica e scattante, come il cobra che oscilla ipnotizzato dalla musica ma pronto allo scatto. Stampata in un unico materiale, resina termoindurente, brillante nel colore bianco, nero o rosso.

This lamp is held into a sphere, two horizontal tops separate the reflector from the base. The reflector's rotatory movement around the central articulation constantly describes new spheres. A sinuous, dynamic and agile shape, like a cobra that swings hypnotized by the music but ready to the spring. It is moulded with one single material, that is to say thermosetting resin, and available in bright colours, white, black or red.

ELIO MARTINELLI









COBRA

ELIO MARTINELLI



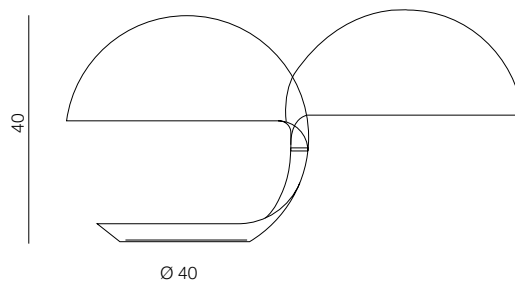

Lampada da tavolo a luce diretta, formata da due corpi stampati in resina. Disponibili nel colore bianco, nero o rosso. Il corpo inferiore ruota sulla base sottostante in acciaio ed è collegato al corpo superiore tramite un giunto centrale che permette la rotazione di 360°. Riflettore interno in alluminio verniciato nel colore bianco.

Reading lamp with direct light, made with two resin molded bodies. White, black or red color availables. The lower body part turns on a steel made base connected with the upper body part by means of a central joint for a 360° rotation. The interior reflector is made with white painted aluminium.



1x12W E27 LED

- 629  bianco lucido / glossy white
- 629/NE  nero lucido / glossy black
- 629/RO  rosso lucido / glossy red







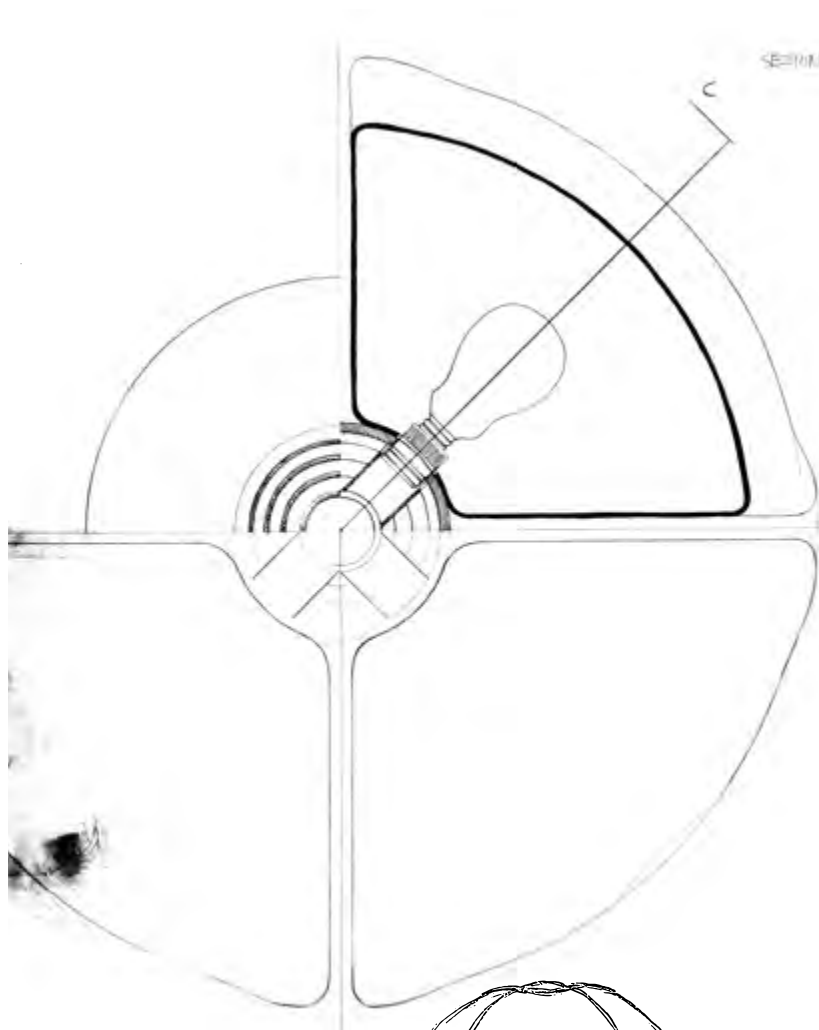

PIPISTRELLO

Ho incontrato Gae Aulenti che ero ancora molto giovane, prima che la trasformazione della Gare d'Orsay in uno tra i più famosi musei d'arte del mondo la facessero conoscere al grande pubblico. Una donna speciale, che nel tempo ho sempre più ammirato avendo avuto modo di conoscerla meglio in occasione dei nostri incontri. Grazie alla condivisione di un comune amico venne in azienda a presentare a mio padre una lampada... il Pipistrello. La lampada non era nata seguendo le mode del momento, ma era stata progettata per lo showroom Olivetti di Parigi. Si dovevano coniugare l'innovazione dei materiali, il metacrilato, e la sicurezza di una forma nota, l'abat-jour, nell'eleganza essenziale dell'italian design che in quel momento iniziava ad imporsi nel mondo dell'arredamento. È questo forse il mix speciale che sta alla base del successo di una lampada che è divenuta una icona del design internazionale, in produzione da oltre 50 anni, e che si rinnova di continuo con colori attuali, varie dimensioni e versioni tecnologicamente all'avanguardia.

I met Gae Aulenti when I was still very young, before the transformation of the Gare d'Orsay into one of the most famous art museums in the world made her known to the wider public. A special woman whom I have come to admire more and more over time, as I had the chance to get to know her better in the meetings we had. Thanks to a mutual friend, she came to the company to show a lamp to my father... the Pipistrello. The lamp was not designed according to the fashions of the moment, but was designed for the Olivetti showroom in Paris. The innovation of the material, methacrylate, and the security of a familiar shape, the lampshade, had to be combined with the essential elegance of Italian design, which at that time was beginning to impose itself on the world of furnishing. This is perhaps the special mix that underlies the success of a lamp that has become an icon of international design, that has been in production for over 50 years, and that is constantly being renewed with current colours, various sizes and technologically advanced versions.

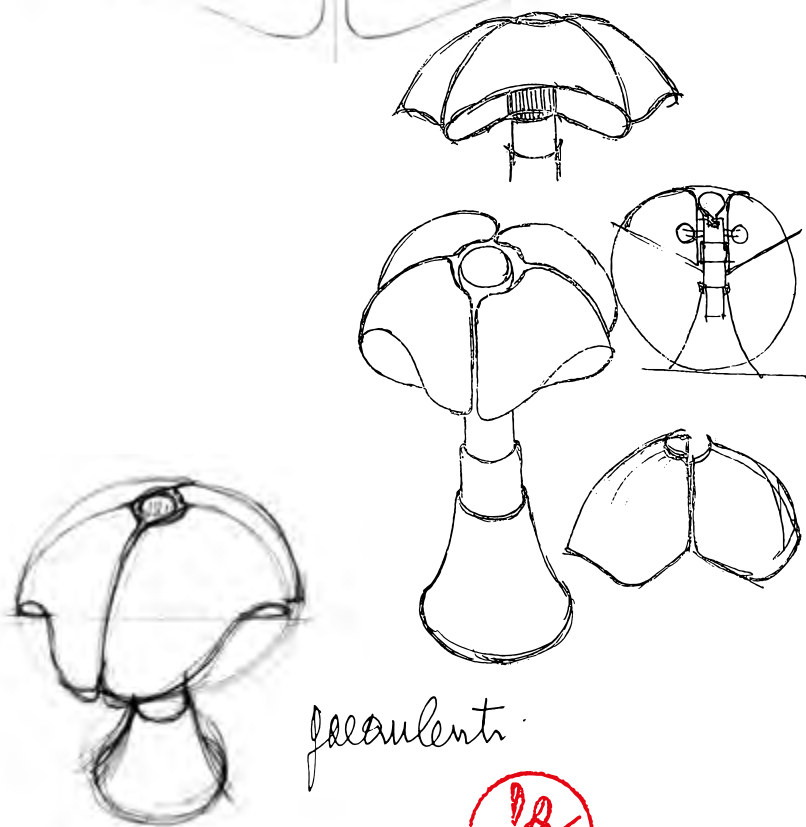

gaulenti



GAE AULENTI





Negozio Olivetti, Venezia.
Bene in concessione al
FAI – Fondo per l'Ambiente Italiano.
In corso durante lo shooting:
"Together. L'abitare contemporaneo di ieri,
oggi e domani", mostra curata da Daniele
Lauria e organizzata in collaborazione dal
FAI, dall'Ordine degli Architetti di Venezia e
dalla rivista IQD.
15 settembre – 21 novembre 2021

Olivetti shop, Venice.
Property in concession to
FAI – Fondo per l'Ambiente Italiano.
During the shooting there was an
event going on: "Together. L'abitare
contemporaneo di ieri, oggi e domani"
(Together. Contemporary living yesterday,
today and tomorrow), an exhibition
curated by Daniele Lauria and organised
in collaboration with FAI, the Ordine degli
Architetti di Venezia and IQD magazine.
15 September – 21 November 2021

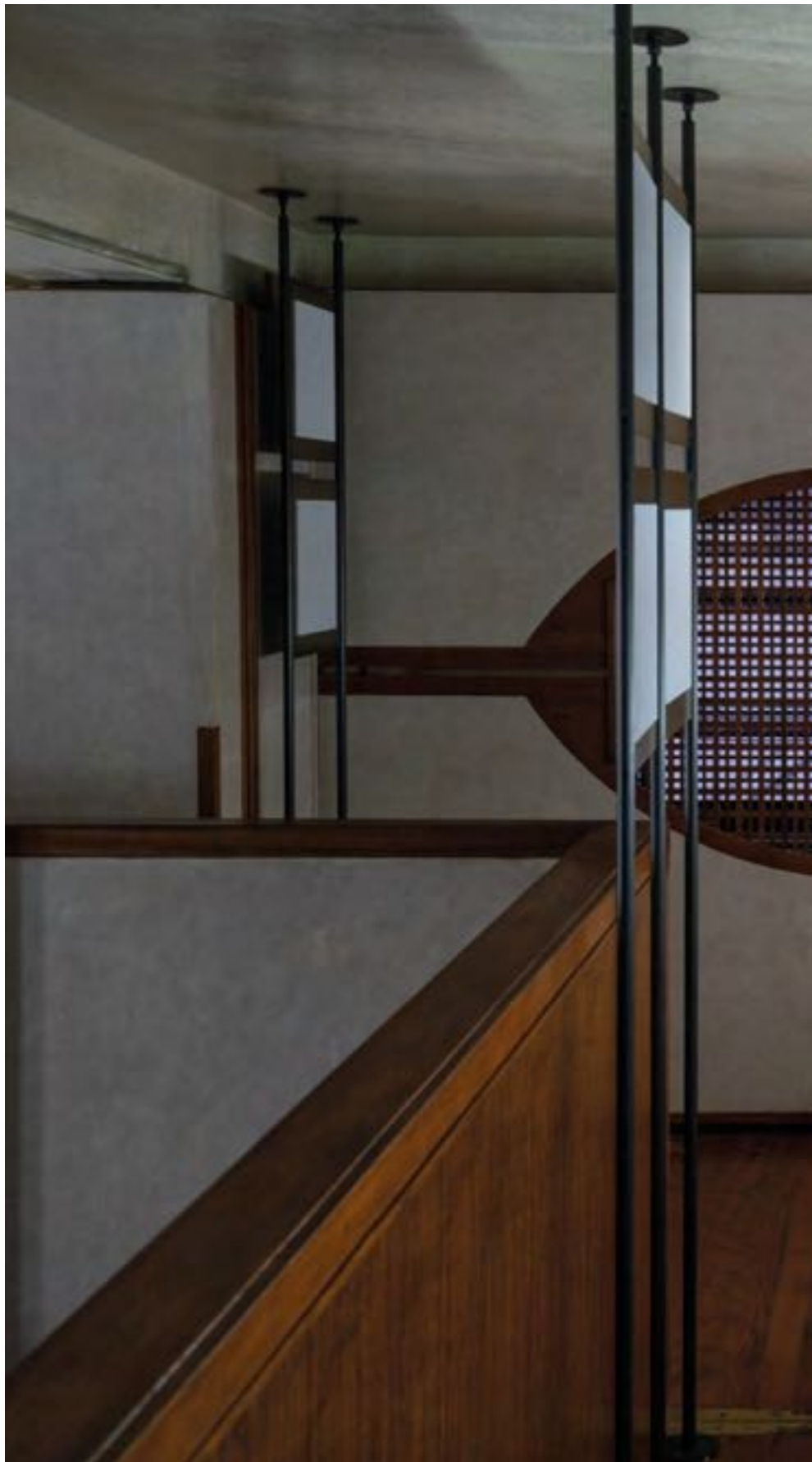



PIPISTRELLO

GAE AULENTI



Lampada da tavolo o da terra a luce diffusa, regolabile in altezza, telescopio in acciaio inox satinato. Diffusore in metacrilato opal bianco, base e pomello in alluminio verniciato nel colore testa di moro, bianco, rosso porpora, nero lucido, titanio, verde agave e in ottone satinato. Completo di lampadine a LED.

Table or floor lamp, diffused light. Adjustable height, glazed stainless steel telescope. White opal methacrylate diffuser. Base and upper knob in lacquered aluminum available in dark brown, white, purple red, glossy black, titanium, agave green and satin brass. LED bulbs included.

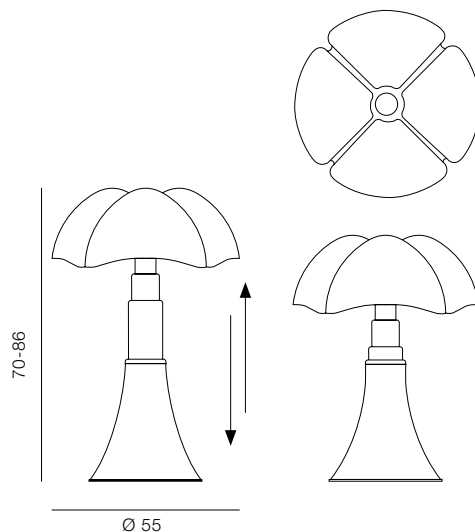

4x5W E14 LED

- 620/MA ● testa di moro / dark brown
- 620/BI ○ bianco / white
- 620/RO ● rosso porpora / purple red
- 620/NE ● nero lucido / glossy black
- 620/TI ● titanio / titanium
- 620/VE ● verde agave / agave green
- 620/OT ● ottone satinato / satin brass



Casa Farralla, arch. Michel Boucquillon e Donia Maoui, Lucca

PIPISTRELLO LED

GAE AULENTI



Lampada da tavolo o da terra a luce diffusa, regolabile in altezza.
Telescopio in acciaio inox satinato. Diffusore in metacrilato opal bianco. Base e pomello in alluminio verniciato nel colore testa di moro e bianco.
Sorgente di luce a LED.
Alimentatore elettronico a spina.

Table or floor lamp, diffused light, adjustable height.
Glazed stainless steel telescope. White opal methacrylate diffuser.
Base and upper knob in lacquered aluminum available in dark brown and white.
With LED light source. Electronic driver on the plug.

14W LED 1400lm 2700K

- 620/DIM/L/1/MA ● testa di moro / dark brown
- 620/DIM/L/1/BI ○ bianco / white

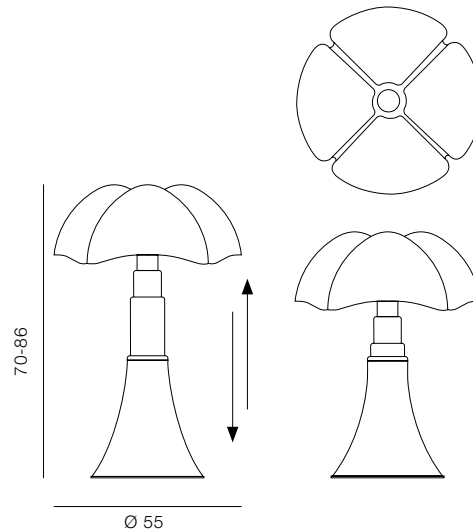



PIPISTRELLO 4.0

GAE AULENTI



LIGHTYOU LIKE

Lampada da tavolo o da terra, a luce diffusa che utilizza la tecnologia tunable white (LED bianco dinamico, vedi pag. 30-31). Telescopio regolabile in altezza in acciaio inox satinato, diffusore in metacrilato opal bianco. Base e pomello in alluminio verniciato in diversi colori. Dimmerabile e con alimentatore elettronico a spina.

Table or floor lamp, providing diffused light using tunable white technology (dynamic white LED, see pages 30-31). Height adjustable telescope in satin stainless steel, diffuser in white opal methacrylate. Base and upper knob in lacquered aluminum available in several colours. Dimmable and with electronic plug-in driver.

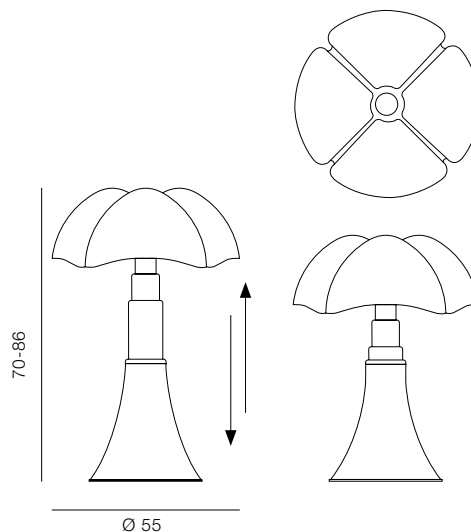

14W LED 2400lm 2500K-6700K

- 620/DIM/BD/L/1/MA  testa di moro / dark brown
- 620/DIM/BD/L/1/BI  bianco / white
- 620/DIM/BD/L/1/TI  titanio / titanium
- 620/DIM/BD/L/1/OT  ottone satinato / satin brass





i modi per la riparazione de
no può essere distolto dal
Nessuno può essere punito
entrata... ore prima del
toposto a misure di sicu
Art. 2... La responsabi
i con
non



PIPISTRELLO MED







Abitazione privata Roberto Del Carlo, Lucca

PIPISTRELLO MED LED

GAE AULENTI



Lampada da tavolo a luce diffusa, regolabile in altezza. Telescopio in acciaio inox, diffusore in metacrilato opal bianco. Base e pomello in alluminio verniciato nel colore testa di moro, bianco, titanio, verde agave o ottone satinato. Sorgente di luce a LED. Alimentatore elettronico dimmerabile a spina.

Table lamp, diffused light, adjustable height. Glazed stainless steel telescope. White opal methacrylate diffuser. Base and upper knob in lacquered aluminum available in dark brown, white, titanium, agave green or satin brass. With LED light source. Dimmable electronic driver on the plug.

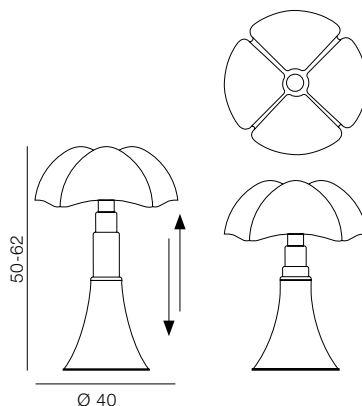

9W LED 850lm 2700K

- 620/MED/DIM/MA ● testa di moro / dark brown
- 620/MED/DIM/BI ○ bianco / white
- 620/MED/DIM/TI ● titanio / titanium
- 620/MED/DIM/VE ● verde agave / agave green
- 620/MED/DIM/OT ● ottone satinato / satin brass





FOTOGRAFIE DELLO STRAORDINARIO
FOTOGRAFIE DELLO STRAORDINARIO
DUCATI
50 ICONE DELLA FOTOGRAFIA
MONT BLANC
CIME DI GLORIA
Interni toscani

MINIPIPISTRELLO





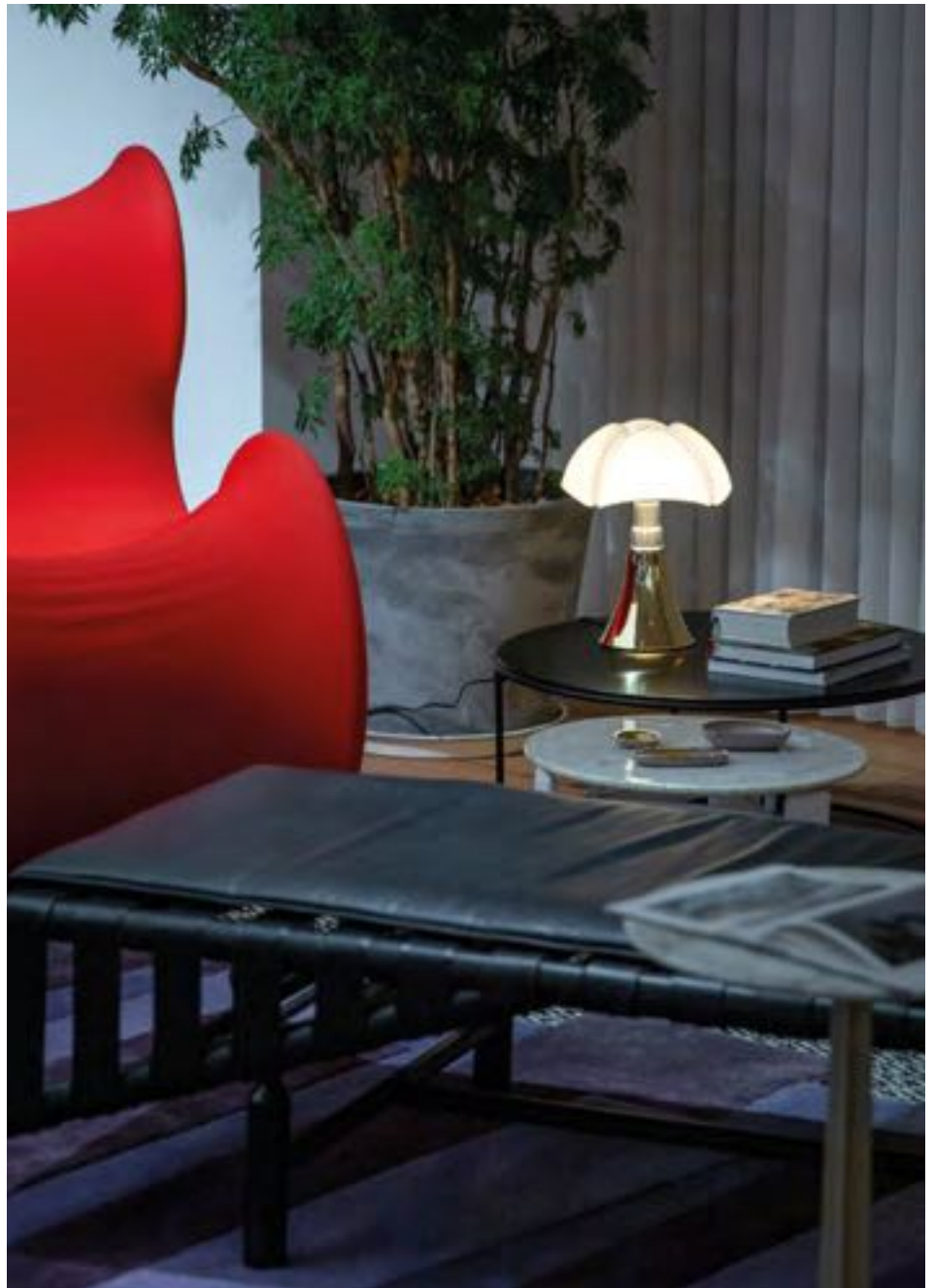

MINIPISTRELLO LED

GAE AULENTI



Lampada da tavolo a luce diffusa. Struttura fissa in acciaio inox, diffusore in metacrilato opal bianco, base e pomello in alluminio verniciato nel colore testa di moro, bianco, rosso porpora, rame, dorato lucido, titanio, verde agave e in ottone satinato. Alimentatore elettronico sulla spina. Sorgente di luce a LED.

Table lamp diffused light. Glazed stainless steel fixed structure, white opal methacrylate diffuser. Base and knob lacquered aluminium in dark brown, white, purple red, copper, glossy gold, titanium, agave green or satin brass. Electronic driver on the plug. LED light source.

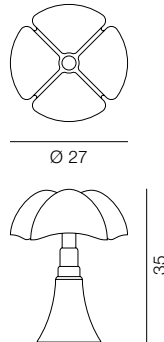

7W LED 700lm 2700K

- 620/J/DIM/MA ● testa di moro / dark brown
- 620/J/DIM/BI ○ bianco / white
- 620/J/DIM/RO ● rosso porpora / purple red
- 620/J/DIM/CU ● rame / copper
- 620/J/DIM/AU ● dorato lucido / glossy gold
- 620/J/DIM/TI ● titanio / titanium
- 620/J/DIM/VE ● verde agave / agave green
- 620/J/DIM/OT ● ottone satinato / satin brass



MINIPISTRELLO CORDLESS

Portatile, dimmerabile, cordless, ricaricabile, pronto da portare ovunque tu desideri: per una cena romantica, un appuntamento in terrazza, un compagno ideale per chi non vuole limiti.

Portable version, dimmable, cordless, rechargeable, is ready to take you wherever you want: for a romantic dinner, a meeting on the terrace, an ideal companion for those who do not want limits.









Ristorante La Mandragora, Pietrasanta, progetto Roberta Patalani

MINIPISTRELLO cordless

GAE AULENTI



Grazie alla tecnologia LED il Minipistrello è disponibile nella versione portatile, dimmerabile, cordless, con batteria ricaricabile e sensore touch. Sistema cordless ricaricabile (carica batteria e batteria forniti) durata 6 ore. Ricaricabile anche con power-banks compatibili. Lampada a luce diffusa, struttura fissa in acciaio inox, diffusore in metacrilato opal bianco, base e pomello in alluminio verniciato nel colore testa di moro, bianco o verde agave.

Thanks to LED technology the Minipistrello is available in the portable version, dimmable, cordless, with rechargeable battery and touch sensor. Cordless rechargeable system (battery and charger supplied) duration 6 hours. Also rechargeable with power-compatible banks. Lamp with diffused light, stainless steel fixed structure, diffuser in white opal methacrylate, painted aluminium base and knob in dark brown, white or agave green colors.

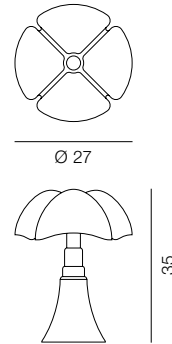

4,5W LED 350lm 2700K

620/J/DIM/T/CL/MA ● testa di moro / dark brown

620/J/DIM/T/CL/BI ○ bianco / white

620/J/DIM/T/CL/VE ● verde agave / agave green



Ristorante Lo Chalet, Torre del lago Puccini





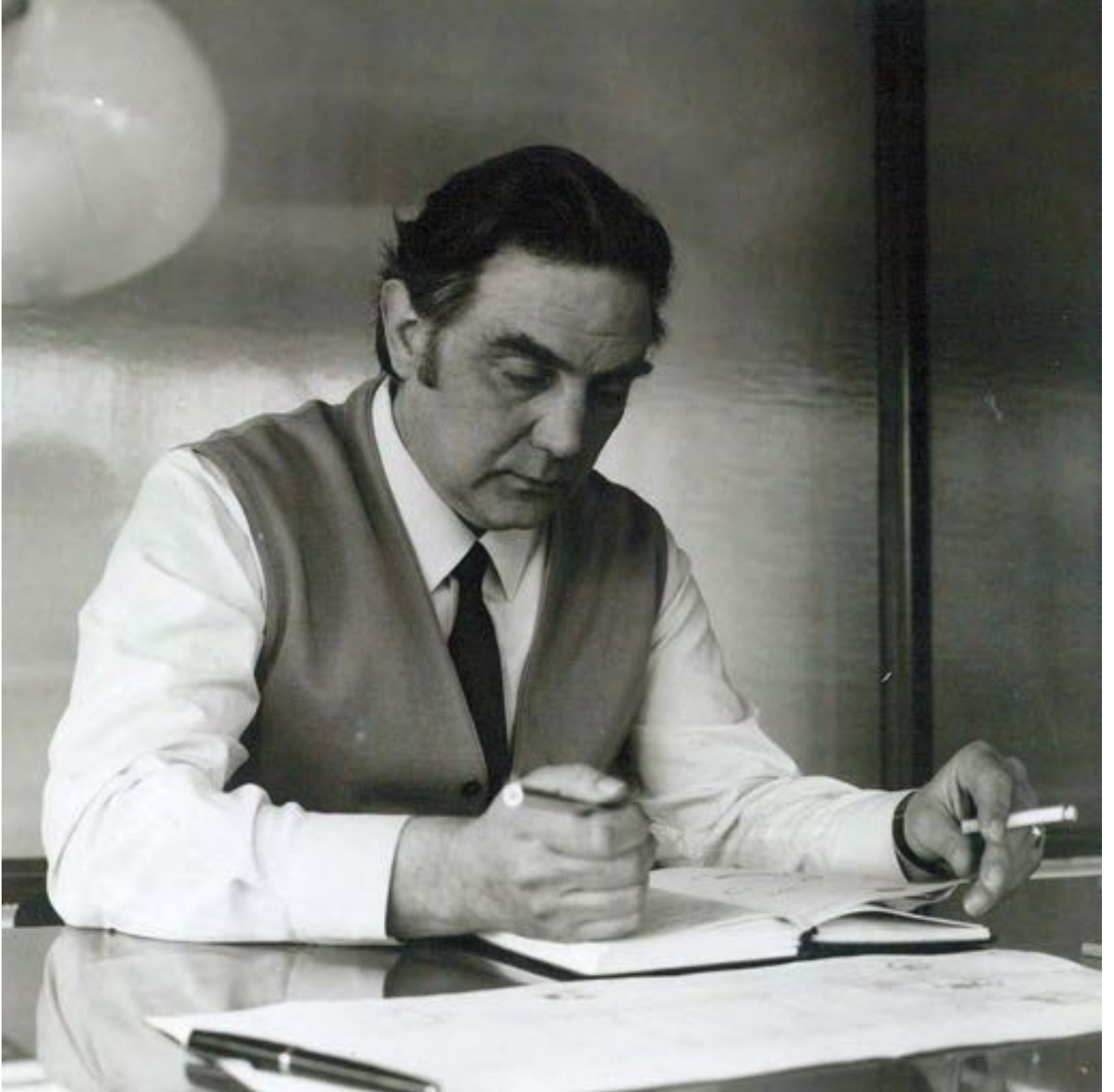

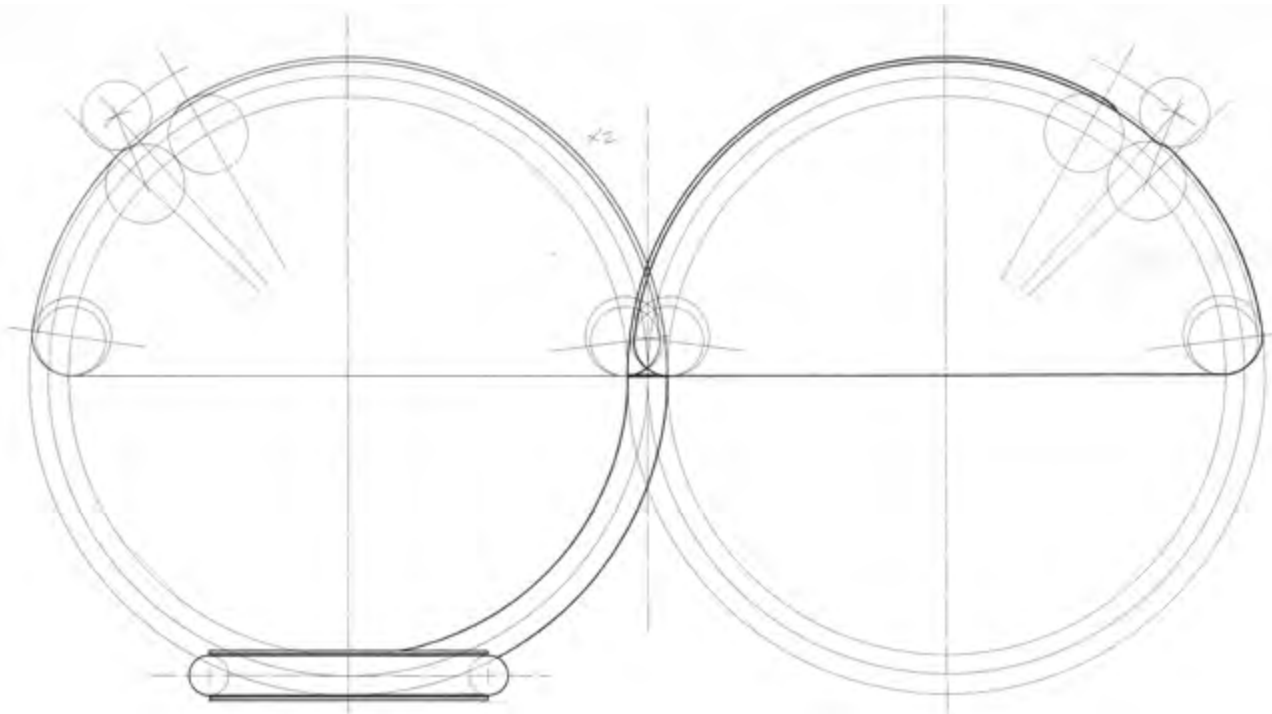

SERPENTE

Il Serpente nella versione da tavolo e da terra è una delle prime lampade disegnate da Elio Martinelli ed è stata presentata alla Fiera di Milano nel 1965. Una lampada a luce diffusa, è forse quella che meglio evidenzia e raccoglie la filosofia progettuale di Martinelli Luce che troviamo in tutta la collezione presentata nel catalogo: le forme geometriche, la natura, il movimento, la sinuosità e la tecnologia. In particolare, il Serpente ha visto l'impiego di un innovativo sistema di stampaggio del diffusore realizzato in materiale plastico, il "Metacrilato opal bianco". Con questa tecnologia è stato possibile realizzare sia l'incavo che accoglie il tubolare in metallo, girevole, a simulare un serpente che va poi ad avvolgere la base conferendo dinamicità alla lampada, sia il particolare sottosquadro in corrispondenza del suo bordo libero, che troveremo in seguito anche in altre lampade, quale segno distintivo della produzione Martinelli Luce degli anni '60.

The Serpente in the table and floor version is one of the first lamps designed by Elio Martinelli and it was presented at the Milan Fair in 1965. A lamp with diffused light, it is perhaps the one that best highlights and brings together Martinelli Luce's design philosophy that we find in the entire collection presented in the catalogue: geometric shapes, nature, movement, sinuosity, technological updating. In particular, the Serpente saw the use of an innovative moulding system for the diffuser made of a plastic material, "white opal methacrylate". With this technology it was possible to create both the socket that houses the metal arm, rotating and tubular, which simulates the snake that descends to wrap around the base, giving dynamism to the lamp, and the particular undercut at its free edge, which will later be found in other lamps as a hallmark of Martinelli Luce production in the '60s.

ELIO MARTINELLI





Casa privata Ciciana, Lucca – archivio Martinelli Luce

SERPENTE

ELIO MARTINELLI

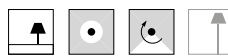

370



Lampada da tavolo a luce diffusa. Braccio girevole e diffusore stampato in metacrilato opal bianco. Braccio e base in metallo verniciato nel colore bianco o dorato. Lampadina LED.
Disponibile anche nella versione da terra.

Table lamp diffused light. Swivelling upper arm and white opal methacrylate diffuser. Metal painted structure in white and in golden color. LED bulb.
Also available in the floor version.

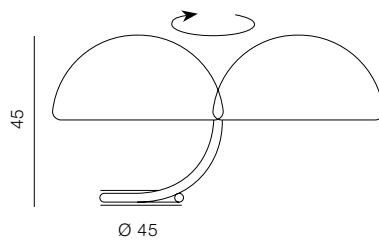

12W E27 LED

599 ○ bianco / white

599/AU ● dorato / golden







LAMPADE A SOSPENSIONE
SUSPENSION LAMPS



AVRO

Grazie alla presa di corrente nella parte inferiore del suo diffusore, non sei più vincolato dall'averne una a muro vicino al tavolo.

Con questo progetto Studio Natural ha voluto non solo semplificare l'attività lavorativa da casa, ma anche facilitare l'uso di dispositivi che necessitano di corrente elettrica, trasformando il tavolo da pranzo in una vera e propria officina funzionale al servizio della creatività di chi la utilizza.

Con Avro la luce è esattamente dove la vuoi, la stagione di caccia alla presa elettrica è chiusa. Mangiare, lavorare o giocare sullo stesso tavolo non è più un problema. Ad ogni attività la sua luce grazie al diverso grado di luminosità che ottieni giocando con la dimmerazione. Il diffusore leggermente inclinato verso il basso ricorda le ali degli aerei Avro RJ-70, da cui la lampada prende il nome.

Avro è una lampada contemporanea ed innovativa.

Thanks to the power socket at the bottom of its shade, you are no longer obliged to have one on the wall next to the table.

With this design, Studio Natural wanted not only to simplify working from home, but also to facilitate the use of devices that require electricity, transforming the dining table into a functional workshop at the service of the user's creativity.

With Avro, light is exactly where you want it, the season of hunting for an electrical socket is over. Eating, working or playing on the same table is no longer a problem. To each activity its own light thanks to the different degree of brightness you get by playing with dimming. The slightly downward tilted diffuser is reminiscent of the wings of the Avro RJ-70 aircraft from which the lamp takes its name.

Avro is a contemporary and innovative lamp.

STUDIO NATURAL

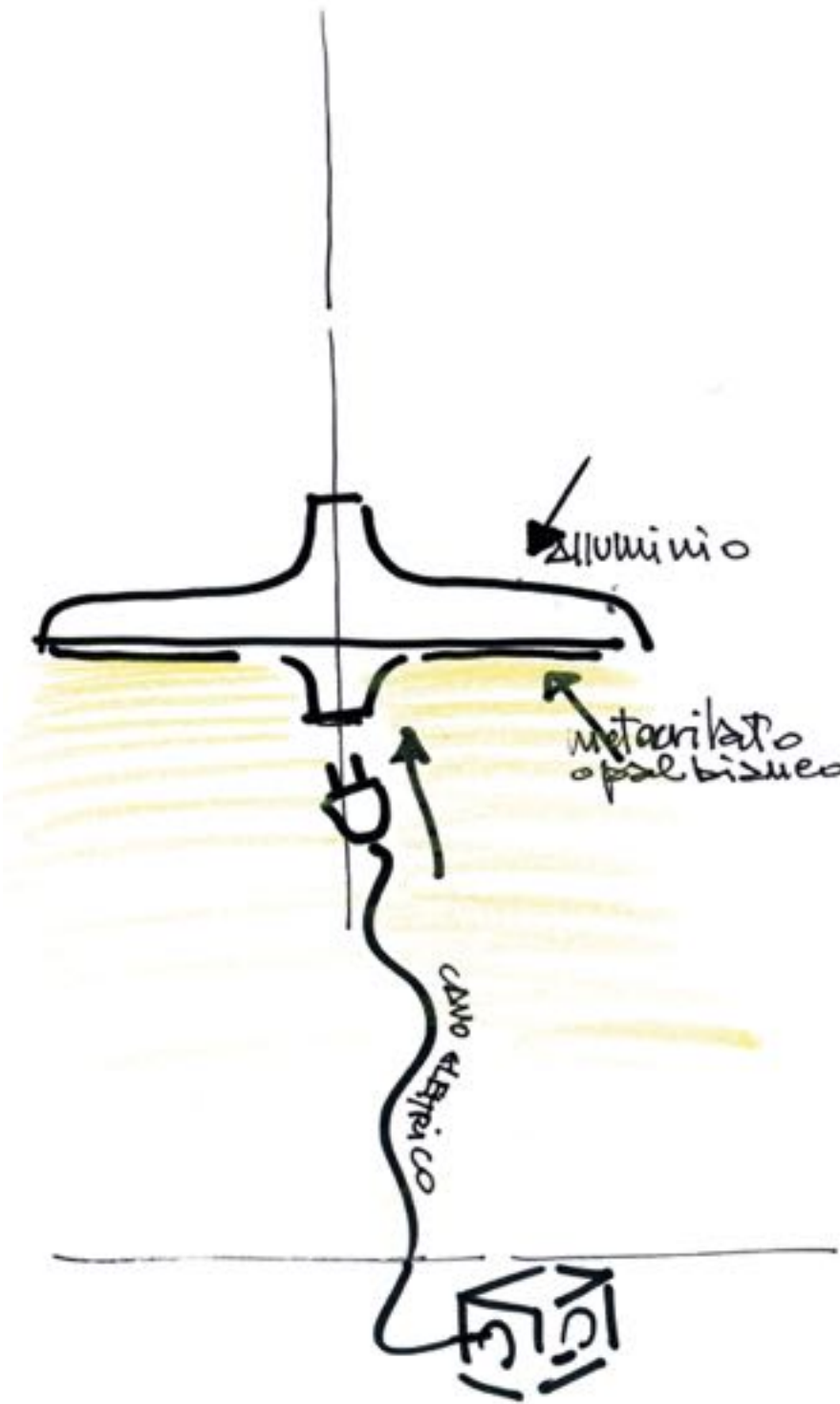





AVRO

STUDIO NATURAL



Lampada a sospensione a luce diretta/
diffusa con sorgente LED dimmerabile.
Struttura in alluminio verniciato nei colori
bianco, nero, azzurro e arancio.
Alimentatore elettronico dimmerabile
all'interno del rosone di attacco al soffitto.
Disponibile come accessorio alla lampada
una multipresa da tavolo corredata di tre
schuko 230V e due USB, max potenza
2,3KW.

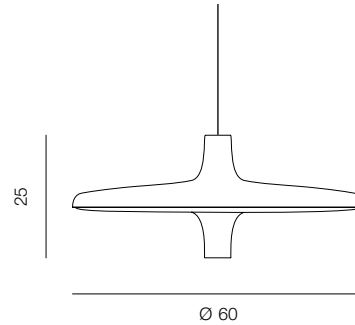

Direct/diffused light suspension lamp with
dimnable LED source. Painted aluminium
structure in white, black, light blue and
orange.
Dimmable electronic driver inside the ceiling
rose.
Multisocket equipped with three 230V
schuko and two USB outlets is available as
a lamp accessory. Max power 2,3KW. its
cable.

36W LED 5000lm 2700K

- 21019/DIM/BI ○ bianco / white
- 21019/DIM/NE ● nero / black
- 21019/DIM/AZ ● azzurro / light blue
- 21019/DIM/AR ● arancio / orange

36W LED 5000lm 3000K

- 21019/DIM/3000/BI ○ bianco / white
- 21019/DIM/3000/NE ● nero / black
- 21019/DIM/3000/AZ ● azzurro / light blue
- 21019/DIM/3000/AR ● arancio / orange

MULTIPRESA / MULTISOCKET

3 Schuko 2 USB - Max 2,3KW

- 40189/GR ● grigio / grey
- 40189/AZ ● azzurro / light blue







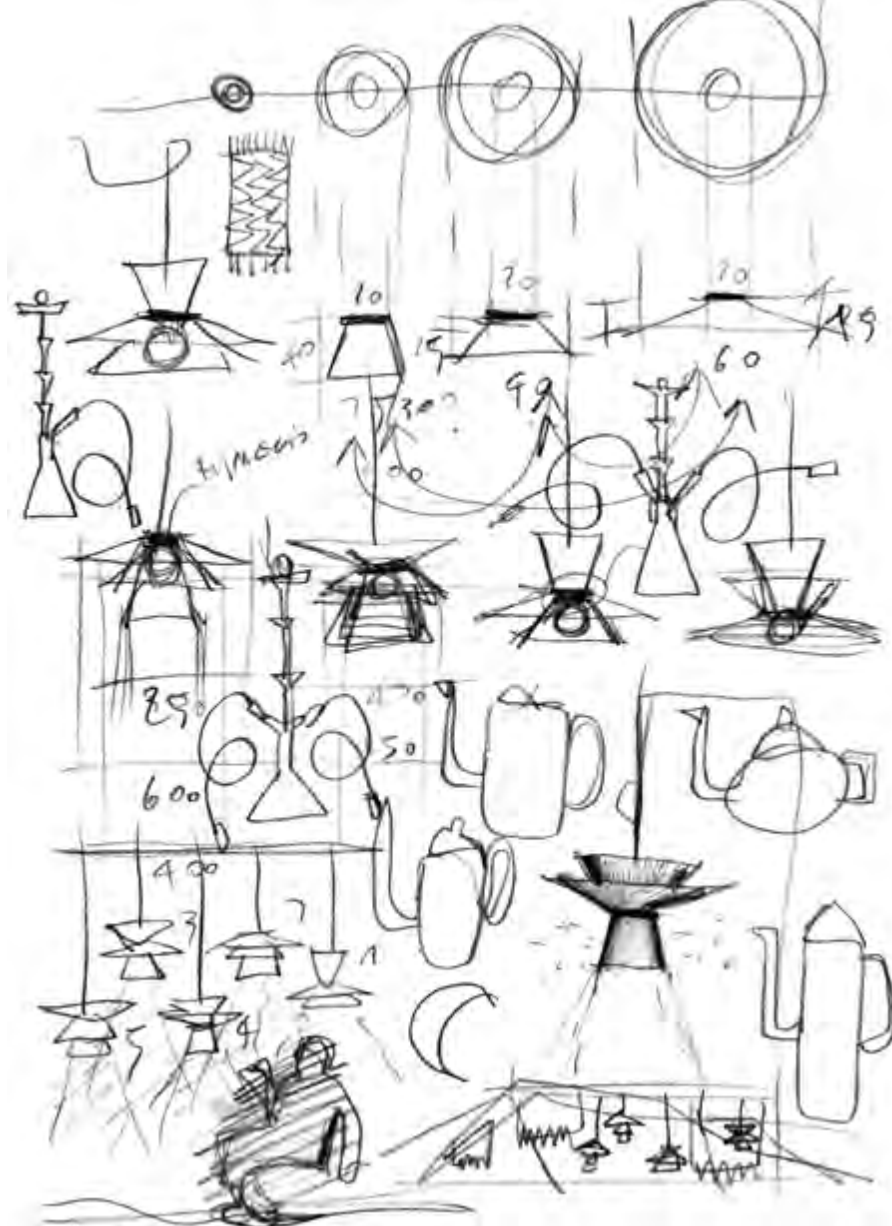

LADY GALALA

Lady Galala è nata durante una riunione sotto una tenda nel deserto montagnoso di Sokhna, progettando i ristoranti sul mare e le residenze de "Il Monte Galala", la città turistica e residenziale che abbiamo progettato e costruito. È immaginata appena mossa dal vento, in un sogno di colori e di allegria, montata e appesa più o meno casualmente, per una serata di shisha, tè, caffè turco, o per un Iftar dopo il tramonto.

Si può montare in varie combinazioni con semplicità. Come un gioco per bambini. E nei vari montaggi assume il volto orientale, quello mediorientale, quello africano, quello mediterraneo, e infine quello di casa nostra. Una madeleine di luce e di leggerezza.

Lady Galala was born during a meeting under a tent in the mountainous desert of Sokhna, while we were planning the seaside restaurants and residences of "Mount Galala", the tourist and residential city we designed and built. It is imagined just moved by the wind, in a dream of colours and joy, mounted and hung more or less randomly, for an evening of shisha, tea, Turkish coffee, or for an Iftar after sunset.

It can be assembled in various combinations with ease. Like a children's toy. And in the various assemblies it assumes the face of the East, the Middle East, Africa, the Mediterranean and finally our own. A madeleine of light and lightness.

C O N T E

NOI SIAMO QUELLI DELLA C
IMMORTALI. SIAMO QUELLI DE
SIAMO QUELLI DI AMMIRAZIONI
AMMIRARE LE SUE PAROLE. N
COSTITUZIONE ITALIANA, QUEL
IL VENTO DI MAFIA MA LE PAR
DI CARAVAGGIO SIAMO TR
QUANDO DICE CHE LA M
QUELLI DELLA 54 MALE D
UN MUSEO PERCHÉ VORREBBERO
SCOTTATURE D'ORTICA, MA VAN



M P L A Z I O N I

LASSE MORTA, PERCHÉ CON I NOSTRI MUSEI RESTEREMO
I RITORNI CHE NON FAN DIMENTICARE IL TERREMOTO. NOI
NI, PERCHÉ SENTIRE QUALCUNO... ALTRO CHE
NOI SIAMO QUELLI CHE CELEBRANO... COLO NOVE DELLA
MOTHIA... MO, NON SEGUONO
OLE DI CE... RANDI. SIAMO QUELLI CHE CONTEMI
RA I PASTORI DELLA NOTTE DI RUBENS, CREDIAMO IN
ENZOGNA CHE CI PERMETTE DI CONOSCERE LA VERITÀ. NO
I VENEZIA. NOI SIAMO QUELLI CHE HANNO MESSO LA MAFIA IN
IMMAGINARLA MORTA, SCONFITTA. NON AVREMO TIMORE DELLE
RCHEREMO L'ATRIO PERCHÉ LA FOLLIA È GIÀ PARTE DI NOI.







LADY GALALA

PELUFFO&PARTNERS



Lampada componibile a sospensione a luce diretta composta da 3 diversi diffusori in metacrilato satinato in 4 colori e da un supporto interno predisposto per lampadina LED. Combinando i tre diffusori di forme diverse si ottengono varie configurazioni (vedi esempi). La combinazione dei diffusori nei diversi colori personalizza la lampada. Possibile anche la combinazione monocromatica.

Disponibile anche nella versione da esterno con diverso supporto con vetro satinato.

Modular direct light pendant lamp consisting of 3 different satin-finish methacrylate diffusers in 4 colours and an internal support prepared for a LED bulb. Combining the three differently shaped diffusers gives various configurations (see examples). The combination of the diffusers in different colours customises the lamp. A monochromatic combination is also possible.

Also available in an outdoor version with a different support with frosted glass.

SUPPORTO alluminio
aluminium support

23W E27 LED

40171/BI ○ bianco / white

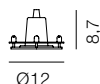

DIFFUSORI / DIFFUSERS

40172/BI ○ bianco / white

40172/GI ● giallo / yellow

40172/AR ● arancio / orange

40172/BL ● blu / blue

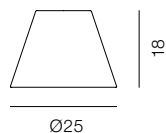

40173/BI ○ bianco / white

40173/GI ● giallo / yellow

40173/AR ● arancio / orange

40173/BL ● blu / blue

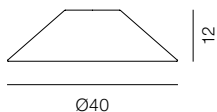

40174/BI ○ bianco / white

40174/GI ● giallo / yellow

40174/AR ● arancio / orange

40174/BL ● blu / blue

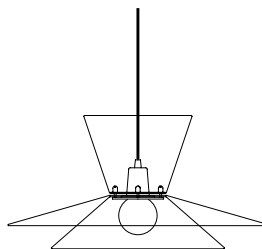
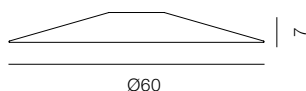

Esempi di composizione
Examples of composition

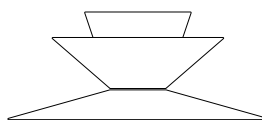
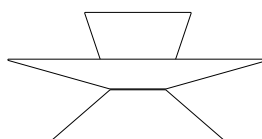
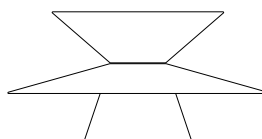
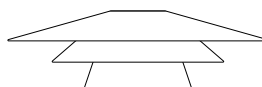
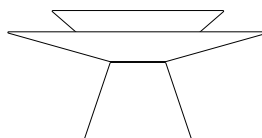
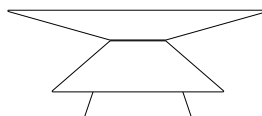
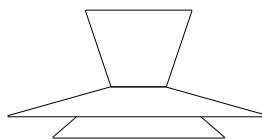







ONDA

Una sospensione rotonda, sobria e dalle linee nette e pure. Il movimento ad onda del diffusore raccorda la luce centrale con il bordo della lampada producendo diverse tonalità di bianco variando l'intensità luminosa. Onda intriga con la sua forma movimentata, morbida e al tempo stesso sensuale, funzionale eppure poetica.

Produce sia luce diretta verso il basso sia luce diffusa d'ambiente, ed è adatta per case private e locali pubblici.

Sia per idea di progetto, sia per forma e materiali specifici, la lampada incarna la qualità e l'immagine proprie all'identità della produzione di Martinelli Luce.

A round and sober suspension lamp, formed by clear and pure lines. The wave-shaped movement of the diffuser connects the central light with the edge of the lamp, producing different shades of white by varying the luminous intensity. The Onda lamp is intriguing by its sloping shape, both soft and sensual, functional yet poetic. It provides both direct downward light and diffused ambient light and is suitable for private homes as well as public spaces. Because of its concept, as well as its particular shape and material, the Onda lamp embodies the qualities and image specific to Martinelli Luce's collection and philosophy.

LUC RAMAEL

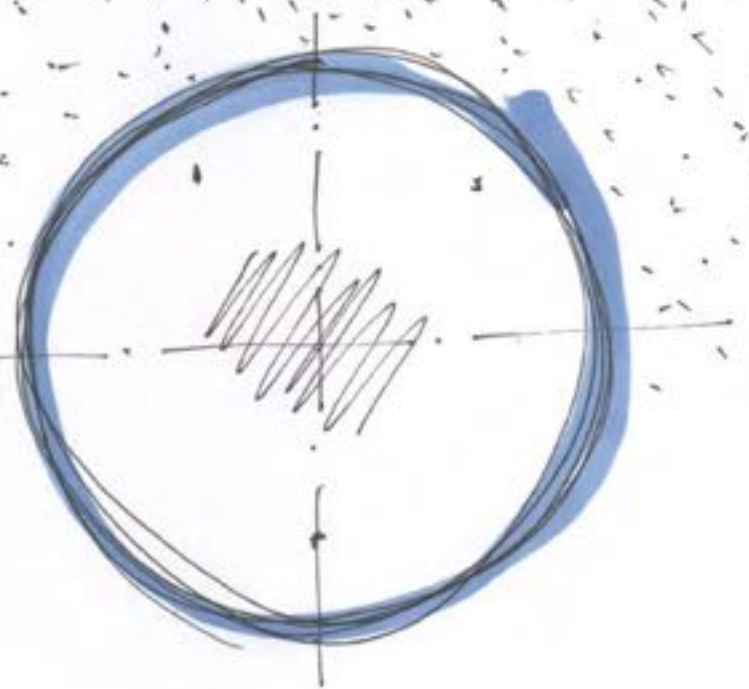

ONDA

LUC RAMAEL



Lampada a sospensione a luce diffusa.
Diffusore in metacrilato opal bianco, la sua particolare forma a onda nasconde la sorgente di luce a LED. Un disco in alluminio verniciato nel colore bianco completo di sorgente di luce a LED è fissato al diffusore e sostiene con il suo cavo la lampada.
Alimentatore integrato nel rosone.

Suspension lamp providing diffused light.
White opal methacrylate diffuser with a particular wave shape that hides the LED light source. A white painted aluminium disc complete with LED light source is attached to the diffuser and supports the lamp with its cable.
Power supply integrated in the ceiling rose.

16W LED 2000lm 2700K

21016/BI ○ bianco / white

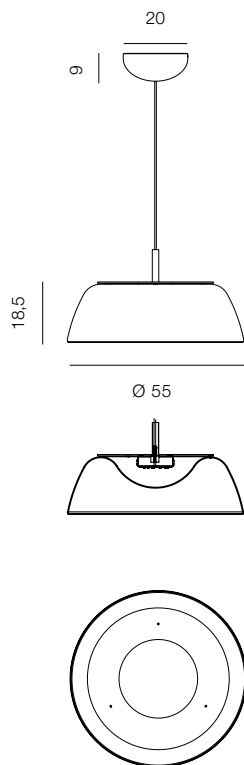





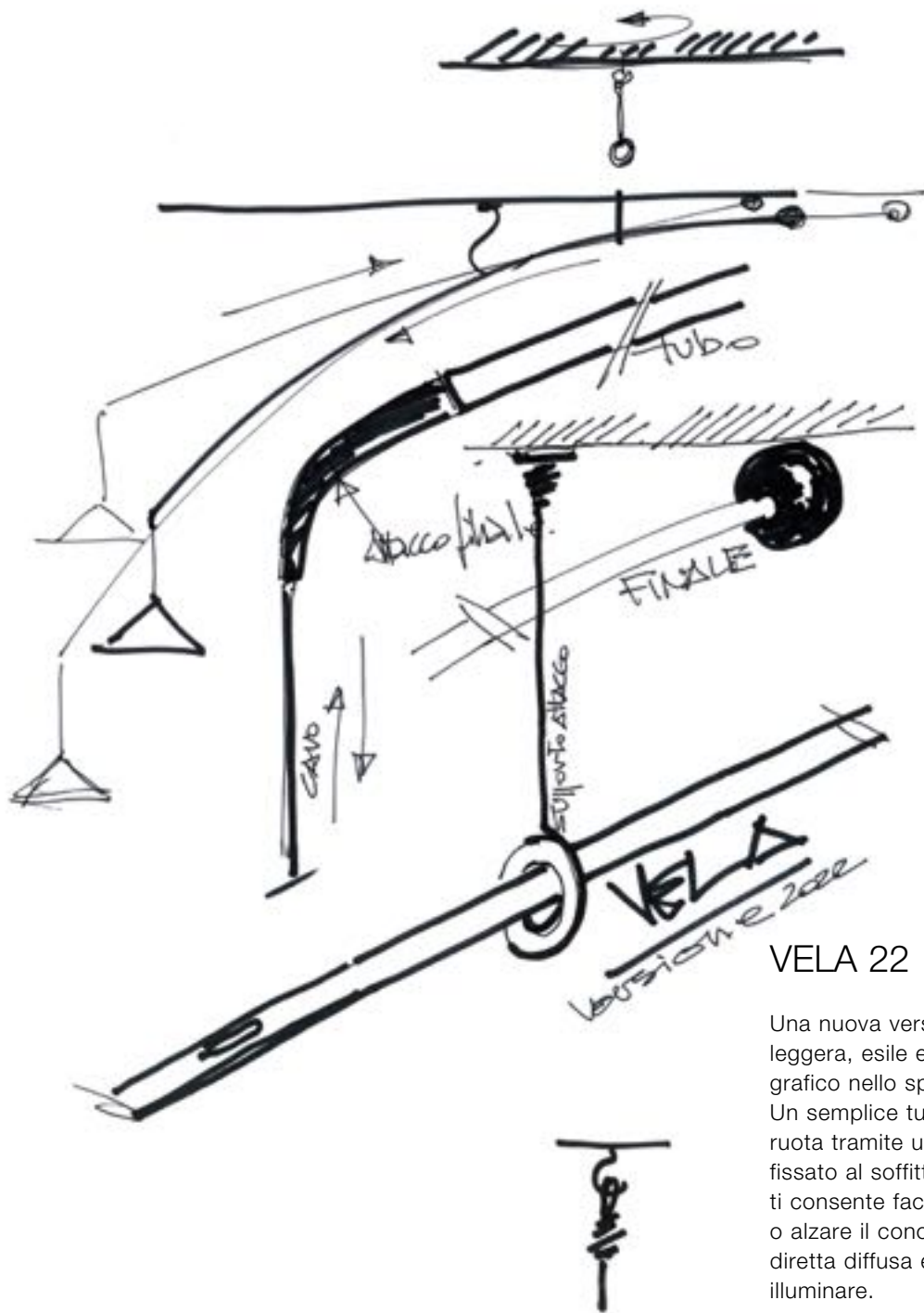

VELA 22

Una nuova versione della lampada Vela, leggera, esile e dinamica. Un segno grafico nello spazio.

Un semplice tubolare di alluminio che ruota tramite un supporto ad anello fissato al soffitto. L'assetto variabile ti consente facilmente di abbassare o alzare il cono in alluminio a luce diretta diffusa e portarlo sulla zona da illuminare.

A new version of the Vela lamp, lightweight, dynamic, thin and swivelling, a graphic sign in space. A simple aluminium tube, which rotates by means of a ring-shaped support fixed to the ceiling and which, thanks to its variable positioning, can be easily lowered or raised so as to bring the aluminium cone with direct diffused light to the area to be illuminated.

ORLANDINI DESIGN





VELA 22

ORLANDINI DESIGN



Lampada a sospensione a luce diretta/diffusa. Formata da un tubolare in alluminio verniciato nel colore nero, girevole sul supporto ad anello centrale e ad assetto variabile. Riflettore in alluminio verniciato nel colore nero, diffusore in policarbonato bianco. Sorgente di luce a LED integrata. Alimentatore dimmerabile integrato nel rosone al soffitto.

Suspension lamp providing direct/diffused light consisting of an aluminium tube painted in black colour, swivelling on the central ring support and with variable positioning. Black painted aluminium reflector, polycarbonate diffuser. Integrated LED light source. Dimmable driver integrated in the ceiling rose.

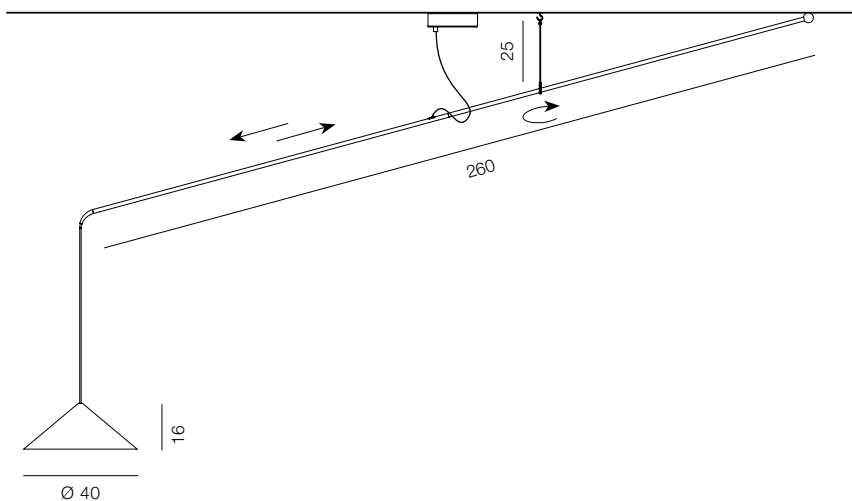

17,5W LED 2200lm 2700K

21017/DIM/NE ● nero / black





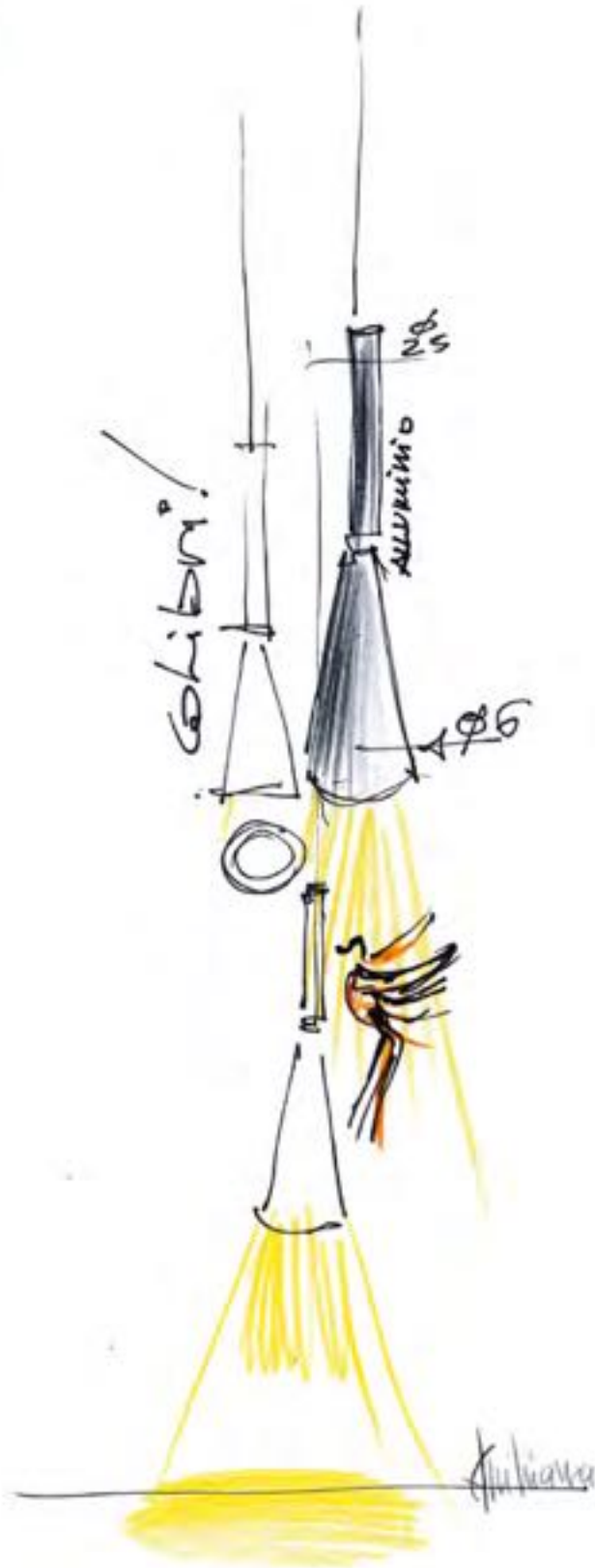

COLIBRÌ

Una piccola sospensione minimale che si inserisce nella vasta famiglia Colibri che comprende molteplici tipologie di lampade, a sospensione, da parete, da terra e da tavolo, studiate per risolvere le problematiche poste dalle diverse esigenze di illuminazione. Una luce diretta a spot, con sorgente di luce a LED. Disponibile anche nella versione con stelo da terra.

A small minimal suspension lamp that is part of the vast Colibri family that includes many types of lamps, suspension, wall, floor and table, capable of solving the problems posed by different lighting requirements.

A direct spot light, with LED light source. Also available in a floor-standing version.

EMILIANA MARTINELLI

COLIBRÌ

EMILIANA MARTINELLI



Lampada a sospensione a luce diretta in alluminio verniciato nei colori nero, bianco o giallo. Sorgente di luce a LED integrata. Alimentatore nel rosone al soffitto.

Suspension lamp with direct light in aluminium painted in black, white or yellow. Integrated LED light source. Driver in the ceiling rose.

6W LED medium 600lm 2700K

21015/NE ● nero / black

21015/BI ○ bianco / white

21015/GI ● giallo / yellow

su richiesta fascio narrow o wide
narrow or wide beam on request

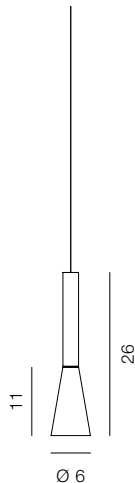





SUJU

L'idea della Suju è nata dall'osservazione, che tutte lampade sospese tra soffitto e terra hanno sempre due fili. Uno per la sospensione, l'altro per l'elettrificazione.

Volevo creare un sistema usando lo stesso cavo. Volevo inoltre offrire la possibilità di uno spostamento in altezza.

Un vecchia carrucola mi è servita come ispirazione per la soluzione tecnica.

Puoi regolare l'altezza con un semplice movimento arrotolando o srotolando il cavo sul corpo lampada. Una soluzione diversa di orientabilità.

The idea for Suju came from the observation that all lamps suspended between ceiling and floor always have two wires. One for suspension, the other for electrification.

I wanted to create a system using the same cable. I also wanted to offer the possibility of height movement.

An old pulley served as inspiration for the technical solution. You can adjust the height with a simple movement by winding or unwinding the cable on the lamp body. A different solution for adjustability.

MICHAEL GELDMACHER

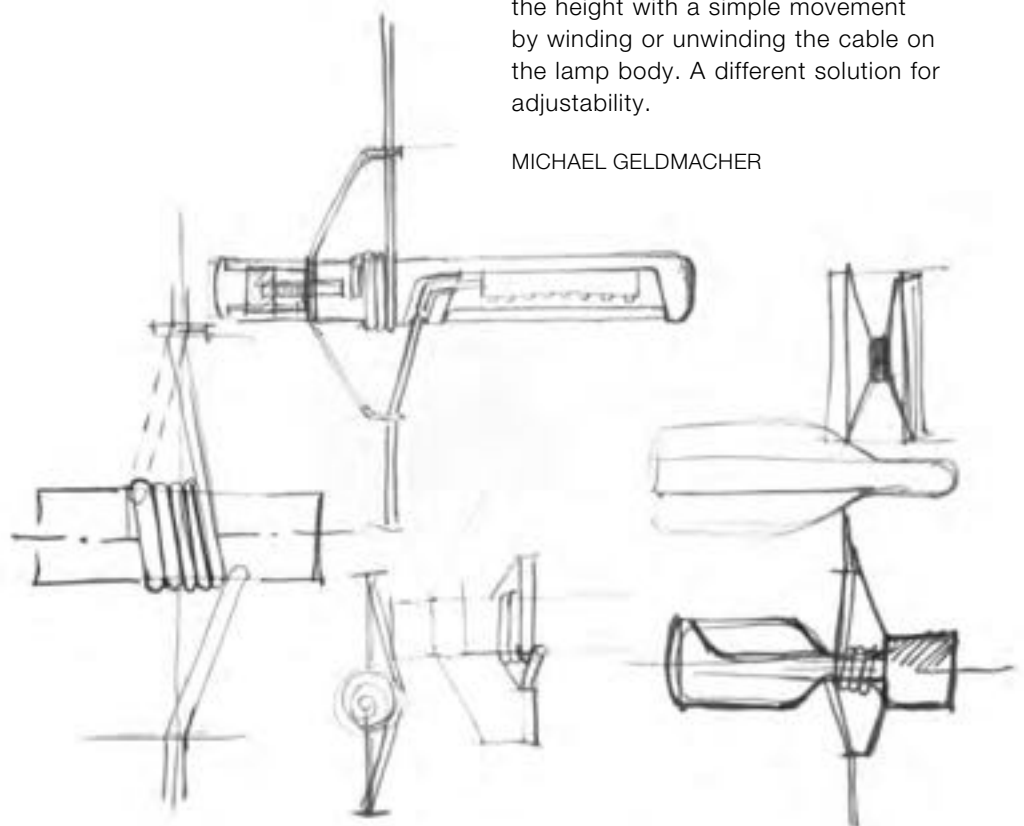





SUJU

MICHAEL GELDMACHER



Lampada da soffitto a luce diretta orientabile e regolabile in altezza tramite la rotazione del corpo lampada, arrotolando e srotolando l'apparecchio sul cavo teso di alimentazione. Sorgente di luce a LED integrato, supporto inferiore dotato di cavo con alimentatore elettronico a spina.

Ceiling lamp, adjustable direct light, height adjustable by rolling up and down the body lamp on the stretched power cable. Integrated LED light source. Cable with electronic driver on the plug in the inferior support.

8W LED 720lm 3000K

21004/BI ○ bianco / white

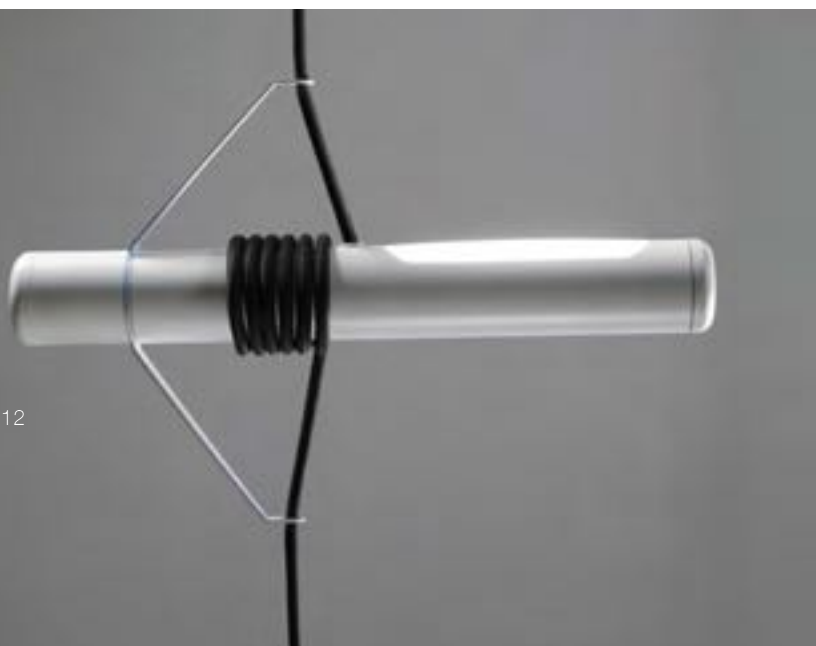
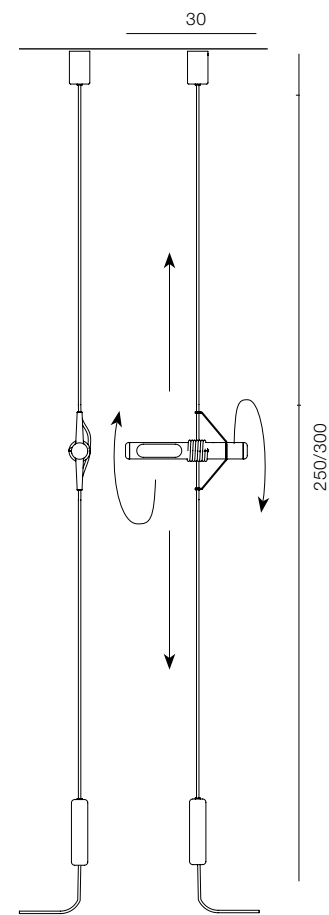





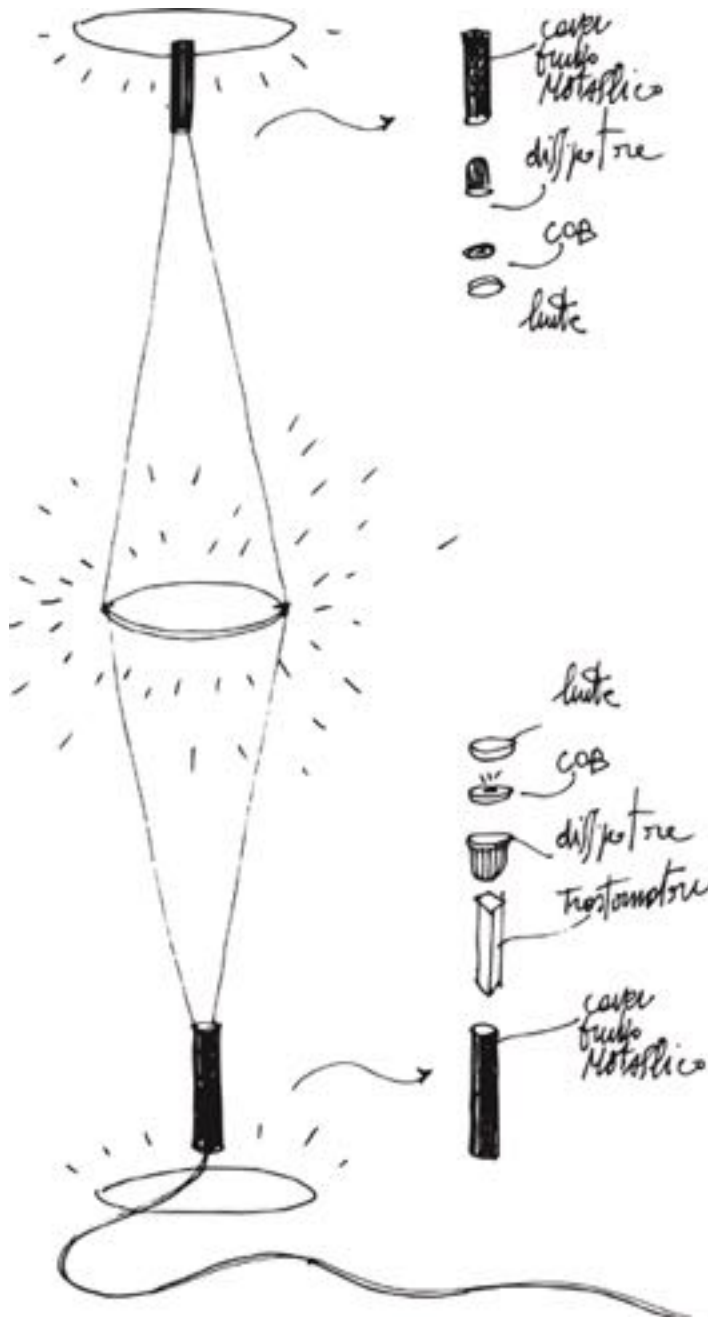

COASSIALE

Volevamo progettare un oggetto che raccontasse la tensione e la gravità. Abbiamo disegnato una lampada mutevole, capace di cambiare il proprio effetto luminoso e la sua geometria astratta.

Due spot uno di fronte all'altro, uno fisso e uno sospeso, sono tenuti insieme da due cavi. Al centro, un disco luminoso in bilico a mezz'aria si muove e diffonde la luce, producendo a terra e a soffitto diverse ombre concentriche.

We wanted to design an object that could speak of tension and gravity. We designed a changing lamp, capable of modifying its light effect and its abstract geometry. Two spotlights one in front of the other, one fixed and the other pendant, held together only by two cables. At the center, a disk of light hanging in mid-air moves and diffuses light, producing different concentric shadows on the floor and on the ceiling.

MARTINELLI VENEZIA STUDIO





Pelletterie Giancarlo, Scandicci, Firenze – arch. Giorgio Ciliberti, Toscana Contract.

COASSIALE

MARTINELLI VENEZIA STUDIO



Lampada a luce diretta e indiretta emessa dalle sorgenti di luce a LED contenute all'interno dei due supporti cilindrici. I due corpi lampada in alluminio verniciato sono posti alle estremità dei due cavi tesi di alimentazione con funzione uno di attacco al soffitto e l'altro di contrappeso. La luce si riflette su un disco orientabile in metacrilato opal bianco che distanzia e scorre lungo i due cavi, in modo da creare diversi effetti di luce. Supporto inferiore completo di cavo con alimentatore elettronico a spina.

Direct and indirect light, thanks to the LED light sources hold inside two colored aluminium cylindrical supports which are at the endpoint of the twice power cables. One is for the ceiling connection, the other one is used as a counter-weight. The light is reflected on a swivel disk in a white opal methacrylate material which spaces and slides along two cables, to create different light effects. Inferior cylindrical support with a cable and an electronic driver on the plug.

2x10W LED 2000lm 3000K

2885/S/NE ● nero / black

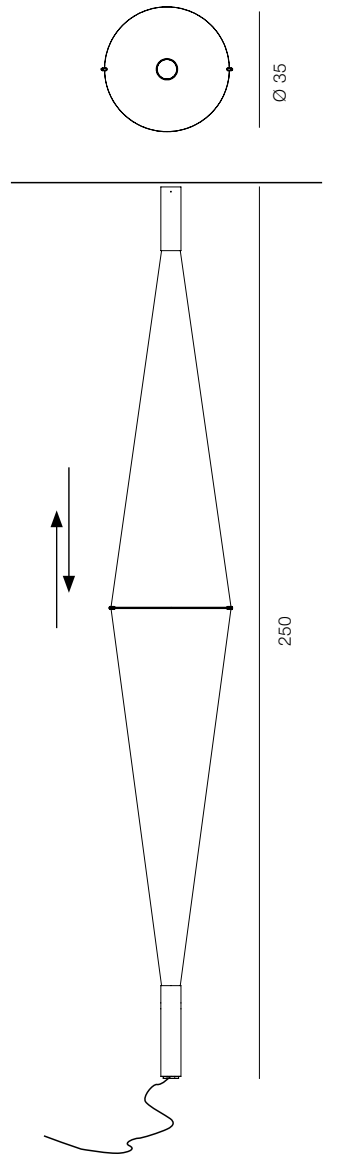





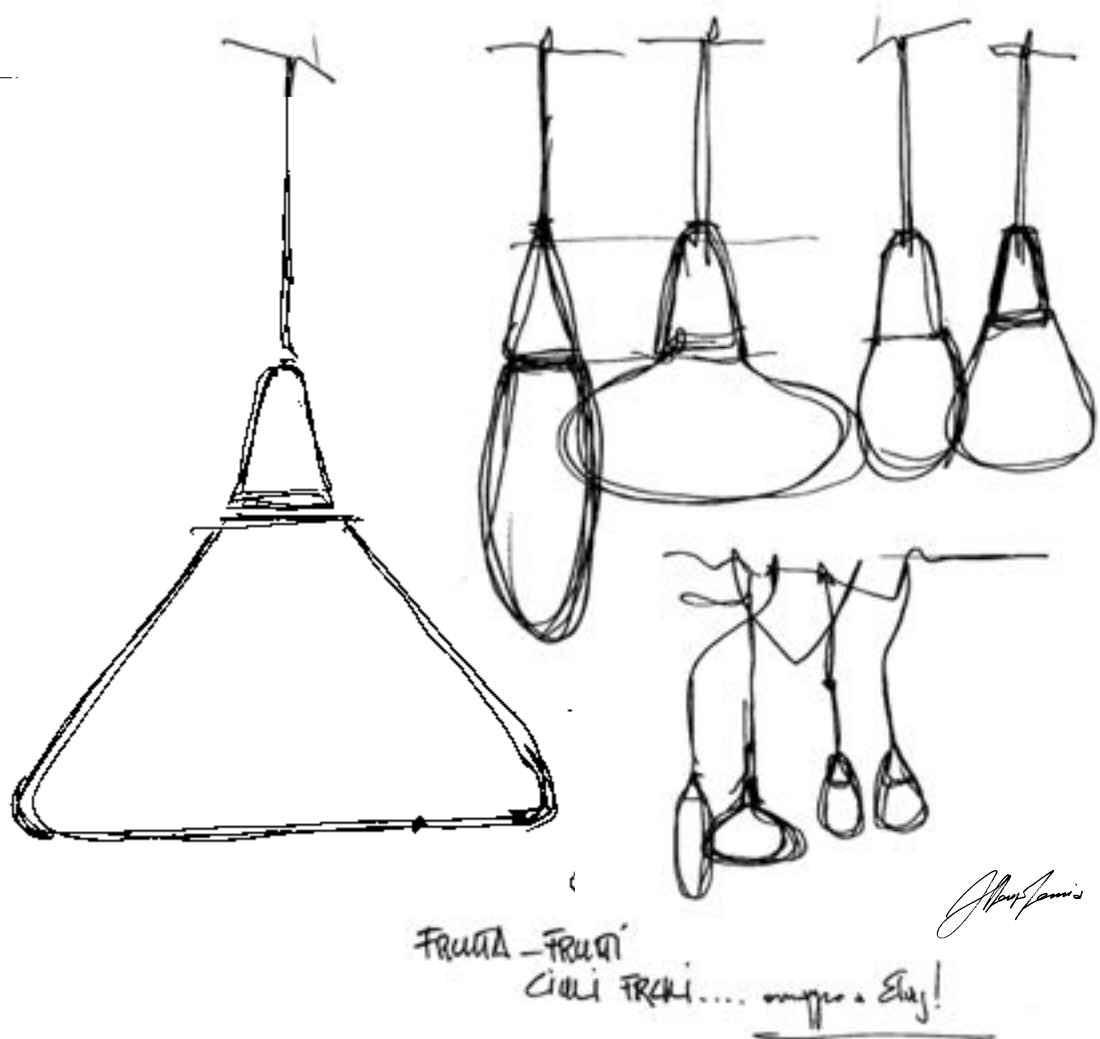

CIULIFRULI

Stupore, gioco, spontaneità. La luce può essere molte cose ma ci emoziona e ci appartiene quando con essa possiamo giocare, scrivere e leggere spazi, ora collettivi ora intimi. Il gioco spontaneo di un dialogo tra sorrisi e sguardi complici, è il voler riaffermare l'importanza di dare sempre forma ad un desiderio, un sogno... che ci accompagna all'inizio del tutto e che poi rischiamo di perdere... imbruttendoci. Allegra, leggera e funzionale, Ciulifruli è progettata per essere appesa tra i rami degli alberi, a un gazebo o sospesa al soffitto, da sola o a grappolo nella versione da interno. Un gioco di forme e colori in grado di ravvivare un angolo del tuo giardino e anche grandi spazi.

Wonder, play, spontaneity. Light can be many things but it moves us and belongs to us when we can play with it, write and read spaces that are at times collective, at times intimate. The spontaneous game of a dialogue between smiles and knowing glances is the will to reaffirm the importance of always conferring shape to a desire, to a dream... that accompanies us back to the beginning of it all and that we then risk losing... to our detriment. Cheery, light and functional, Ciulifruli is designed to be hung amidst the branches of a tree, in a gazebo or from the ceiling, alone or in a bunch in the indoor version. A game of shapes and colors that enlivens a corner of your garden as well as large spaces.

ATELIER(S) A. FEMIA &
EMILIANA MARTINELLI





CIULIFRULI indoor



ATELIER(S) A. FEMIA & EMILIANA MARTINELLI

Lampada a sospensione per interno a luce diffusa da comporre con supporto + diffusore in polietilene stampati in rotazionale.
 Diffusori nel colore bianco in 5 forme diverse e supporti in 5 colori. Per lampadina a LED.
 Tre versioni: Sospensione singola (A), con cavo bianco, diffusore e rosone.
 Versione a grappolo (B3-B5) e versione a ragno (C3-C5) vedi pagina successiva.
 Disponibile anche nella versione da esterno (IP65) con cavo arancio e spina, vedi catalogo outdoor.

Suspension lamp diffused light for indoor to compose with support + diffuser in polyethylene rotational moulded.
 White diffusers in 5 different shapes and supports in 5 different colours.
 For LED bulb.
 Three versions: Single suspension (A) with white cable, diffuser and rose.
 Cluster version (B3-B5) and spider version (C3-C5) see next page.
 Available also outdoor versions (IP65) with orange cable and plug, see outdoor catalog.

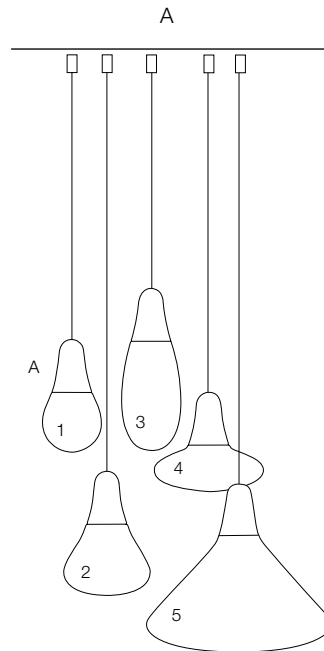

A) SUPPORTI / SUPPORTS

- 30857/BI ○ bianco / white
- 30857/AZ ● azzurro / light blue
- 30857/VE ● verde / green
- 30857/GI ● giallo / yellow
- 30857/RO ● rosso / red

DIFFUSORI / DIFFUSERS

- 1) 30859/BI ○ bianco / white Ø16 H 16
- 2) 30860/BI ○ bianco / white Ø23 H19
- 3) 30861/BI ○ bianco / white Ø15 H29
- 4) 30862/BI ○ bianco / white Ø29 H12,5
- 5) 30903/BI ○ bianco / white Ø50 H40

LAMPADINE / BULBS

- 5056 5,3 W E27 LED (mod. 4)
- 5049 10 W E27 LED (mod. 1-2-3-5)
- 5278 14 W E27 LED (mod. 1-2-3-5)





Biennale di Architettura agli Arsenali Repubblicani, Pisa 2019 – direttore arch. Alfonso Femia

CIULIFRULI indoor

ALFONSO FEMIA & EMILIANA MARTINELLI



La lampada Ciulifruli è disponibile, oltre che nella versione singola, (vedi pagina precedente) nella versioni:
a Cluster composta con più lampade e rosone completo di alimentatore B3-B5,
e nella versione Spider C3-C5.

The Ciulifruli lamp is available, in addition to the single version, (see previous page) in the versions:

a Cluster consisting of several lamps and a rosette complete with B3-B5 ballast,
and in the Spider version C3-C5.

A) SUPPORTI / SUPPORTS

- 30863/BI ○ bianco / white
- 30863/AZ ● azzurro / light blue
- 30863/VE ● verde / green
- 30863/GI ● giallo / yellow
- 30863/RO ● rosso / red

DIFFUSORI / DIFFUSERS

- 1) 30859/BI ○ bianco / white Ø16 H 16
- 2) 30860/BI ○ bianco / white Ø23 H19
- 3) 30861/BI ○ bianco / white Ø15 H29
- 4) 30862/BI ○ bianco / white Ø29 H12,5
- 5) 30903/BI ○ bianco / white Ø50 H40

ROSONI / CEILING ROSE

- B3) CLUSTER 3 lampade/lamps
30901/BI ○ bianco / white Ø 16 H 4
- B5) CLUSTER 5 lampade/lamps
30867/BI ○ bianco / white Ø 16 H 4
- C3) SPIDER 3 lampade/lamps
30864/BI ○ bianco / white Ø 40 H 4
- C5) SPIDER 5 lampade/lamps
30865/BI ○ bianco / white Ø 40 H 4

LAMPADINE / BULBS

- 5056 5,3 W E27 LED (mod. 4)
- 5049 10 W E27 LED (mod. 1-2-3-5)
- 5278 14 W E27 LED (mod. 1-2-3-5)

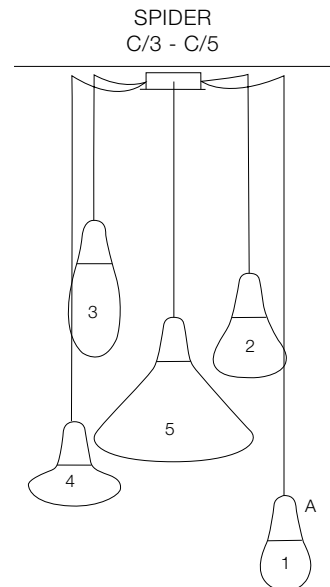
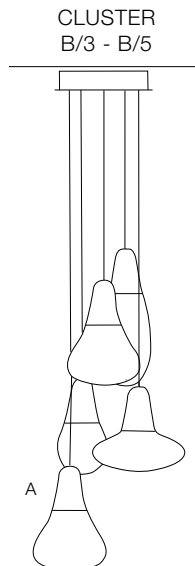

CLUSTER 3 lampade/lamps (B3)

- 3 Supporti / Supports
30863 (/BI /AZ /VE /GI /RO)
- 1 Rosone / Ceiling rose 30901
- 3 Diffusori / Diffusers
30859/30860/30861/30862/30903

SPIDER 3 lampade/lamps (C3)

- 3 Supporti / Supports
30863 (/BI /AZ /VE /GI /RO)
- 1 Rosone / Ceiling rose 30864
- 3 Diffusori / Diffusers
30859/30860/30861/30862/30903

CLUSTER 5 lampade/lamps (B5)

- 3 Supporti / Supports
30863 (/BI /AZ /VE /GI /RO)
- 1 Rosone / Ceiling rose 30867
- 3 Diffusori / Diffusers
30859/30860/30861/30862/30903

SPIDER 5 lampade/lamps (C5)

- 5 Supporti / Supports
30863 (/BI /AZ /VE /GI /RO)
- 1 Rosone / Ceiling rose 30865
- 5 Diffusori / Diffusers
30859/30860/30861/30862/30903





TRILLY

Un'ispirazione "geometrica": un cono di luce; volevo che la lampada rendesse quest'effetto sia da accesa che quando spenta. Grazie al foro che è stato possibile realizzare al vertice del cono utilizzando la tecnica di stampaggio rotazionale, la puoi prendere con due dita e trasportarla facilmente.

Una lampada mobile, versatile, da spostare all'aperto dal ramo di un albero a sotto il gazebo, da appoggiare sul prato o sul pavimento di casa, sul tavolo da lavoro, la sera accanto al divano, in camera, e con supporto da fissare al muro.

A "geometric" inspiration: a cone of light; I wanted the lamp to have this effect both when switched on and when switched off. Thanks to the hole made at the top of the cone using the rotational moulding technique, you can pick it up with two fingers and carry it easily.

A mobile, versatile lamp that can be moved outdoor from the branch of a tree to under the gazebo, placed on the lawn or on the floor at home, on the work table, in the evening next to the sofa, in the bedroom, and with support to be fixed to the wall.

EMILIANA MARTINELLI



TRILLY

EMILIANA MARTINELLI



Lampada per esterno e interno a sospensione da appoggio e da parete, a luce diffusa. Struttura in polietilene stampata con la tecnologia rotazionale. Per lampadina LED. Cavo di alimentazione arancio 5m con spina. Disponibile in due dimensioni.
Gancio per il fissaggio a parete (optional).

Indoor and outdoor suspension, floor or wall lamp, with diffused light. Rotational moulded technology in white polyethylene material. For LED bulb. Orange power cable and plug 5m. Available in two sizes.
Wall fixing hook (optional).

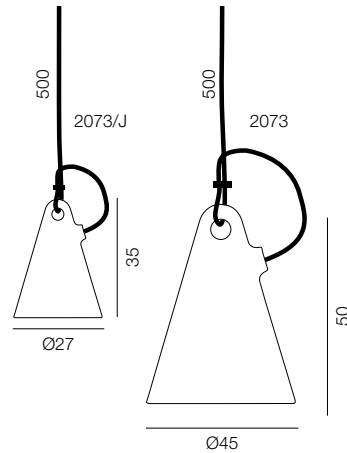

TRILLY Ø27
1x6W E27 LED

2073/J ○ bianco / white

TRILLY Ø45
1x15W E27 LED

2073 ○ bianco / white

Gancio per attacco a parete
Hook for wall mounting

30837 ● nero / black





Plissé

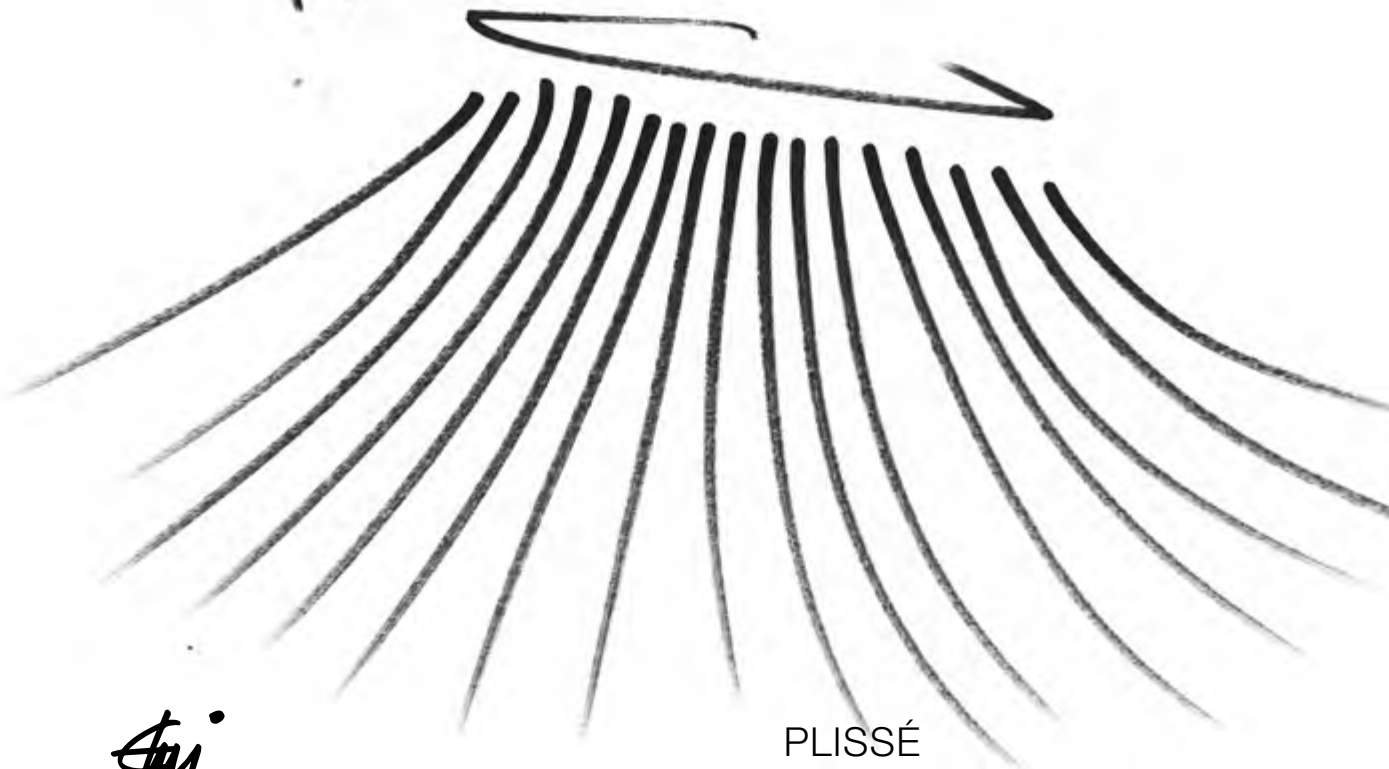

Emi

PLISSÉ

Il Metacrilato con le sue proprietà di diffondere la luce, ha ispirato la mia fantasia e mi ha portato a disegnare questa particolare lampada. Il Metacrilato riesce infatti a trasmettere la luce di una corona invisibile di LED nel suo spessore trasparente fino al taglio perimetrale e ai punti di incisione, come le mille righe in questo caso, che rimandano l'immaginazione ad una gonnellina "plissé". La forma orientaleggiante, la leggerezza, le linee sfuggenti esaltano questo effetto, per ballare nell'aria e per tuffarsi in un sogno.

Methacrylate, with its light-diffusing properties, inspired my imagination and led me to design this particular lamp. In fact, methacrylate is able to transmit the light of an invisible crown of LEDs in its transparent thickness right down to the perimeter cut and the engraving points, such as the thousand lines in this case, which send the imagination back to a "pleated" skirt. The oriental shape, the lightness, the fleeting lines enhance this effect, to dance in the air and to dive into a dream.

EMILIANA MARTINELLI



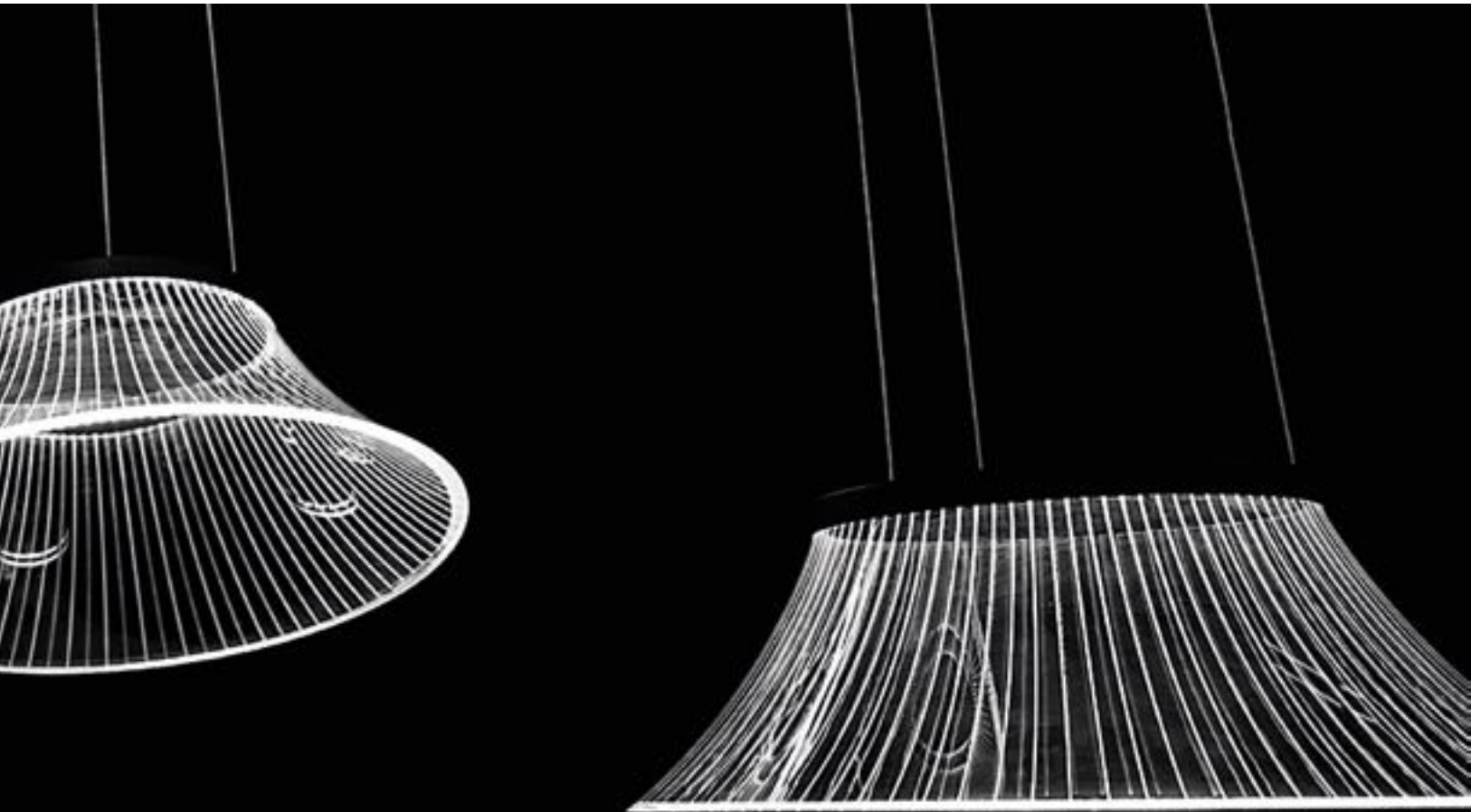

PLISSÉ

EMILIANA MARTINELLI



Lampada a sospensione a luce diffusa.
Caratterizzata dal diffusore in metacrilato trasparente con segni grafici a laser, che illuminati da una sorgente di luce a LED all'interno del supporto circolare in alluminio verniciato nel colore antracite, definiscono la sua forma. Alimentatore elettronico all'interno del rosone al soffitto.

Suspension lamp, diffused light. With a transparent methacrylate diffuser and laser drawn lines effect, which are lighted by a LED light source inside an anthracite painted aluminium circular support, defines its shape. Electronic driver integrated in the ceiling rose.

11,5W LED 1150lm 3000K

21002/AN ● antracite / anthracite

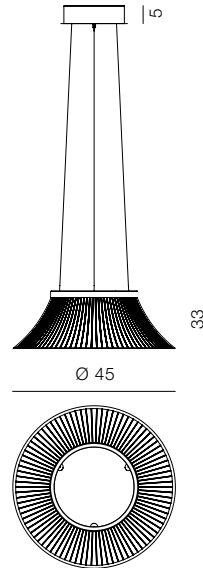





MODENA

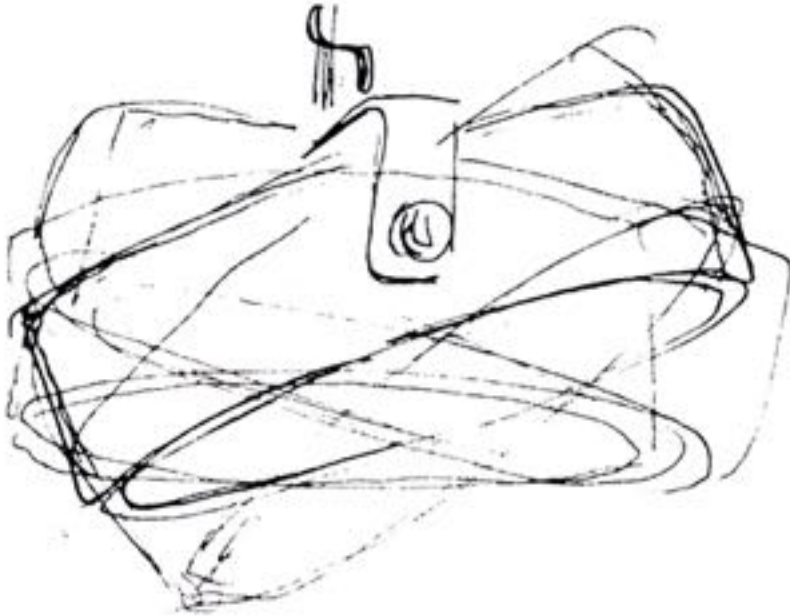

Modena è la sintesi tra un'estetica tecnologica, contemporanea e una spiccata matericità che trasforma un prodotto di design in un oggetto dell'affezione. Questa dicotomia è subito palesata nell'abbinamento dei materiali: la lampada è realizzata in alluminio verniciato abbinato a un colore grafico. Il diffusore raccoglie e proietta la luce verso il basso, in un cono luminoso morbido e aperto. La foratura laterale lascia filtrare quel tanto di luce che serve ad ammorbidire il passaggio tra la zona in ombra e quella illuminata, creando una delicata trama sulla superficie. Modena è sviluppata nelle versioni a sospensione e da parete. L'intera famiglia è caratterizzata da un'estrema flessibilità di orientamento. Infatti, tutte le tipologie hanno il diffusore orientabile che, nella versione da parete, ruota anche attorno all'asta di supporto. Questa grande dinamicità rende la lampada molto versatile, adatta a connotare ambienti domestici ma anche pubblici e di dimensioni importanti, dove la giustapposizione dello stesso elemento con leggere variazioni di orientamento crea un elegante e piacevole effetto ritmico.

Modena is the synthesis between a high-tech and contemporary appeal and a powerful materic character that transforms an object of design into an objet of affection. This dychotomy is immediately evident in the combination of materials: Modena always comes in a painted aluminium finish paired with a graphic color. The diffuser generates a wide light cone providing downward diffused lighting. The lateral pouncuring lets a sufficient amount of light filter through to soften the transition between shade and brightness, drawing a delicate texture/weft on the metal surface. Modena comes in two versions: pendant and wall lamp. The family's essence is flexibility. The diffuser rotates so that it can be aimed in different directions. In the wall versions, the diffuser rotates around its support. This great dynamism makes the lamp very versatile, ideal for residential environments but also for public venues of significant dimensions, where juxtaposing the same element with slight variations in orientation creates an elegant and pleasant rhythmic effect.

MODENA

STUDIO AREA-17

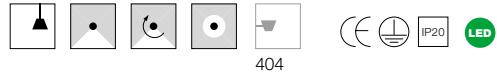

404

Lampada a sospensione orientabile a luce diretta diffusa. Struttura in alluminio verniciato in corten con pomelli rossi. Diffusore in metacrilato opal bianco. Per sorgente di luce a LED e alimentatore dimmerabile integrato nel corpo lampada.

Adjustable suspension lamp direct diffused light. Structure in painted aluminium: corten color with knobs red. White opal methacrylate diffuser. For LED light source and dimmable driver inside the body lamp.

13W LED 1600lm 3000K

2099/L/1/CO ● corten / corten
pomelli rossi / red knobs

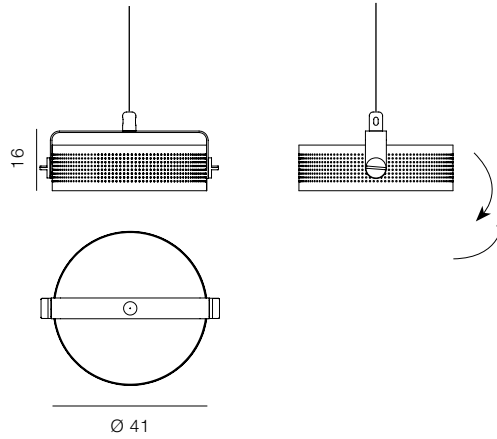



*...le un...
...al momento...
...tantissime farciture...
...anche per...
...i sapori...
...non...
...le tigelle? Ecco una piccola...
...roduzione...
...farcito con salumi, formaggi e verdure...
...come tigella, che è il nome del disco di terracotta sul quale...*



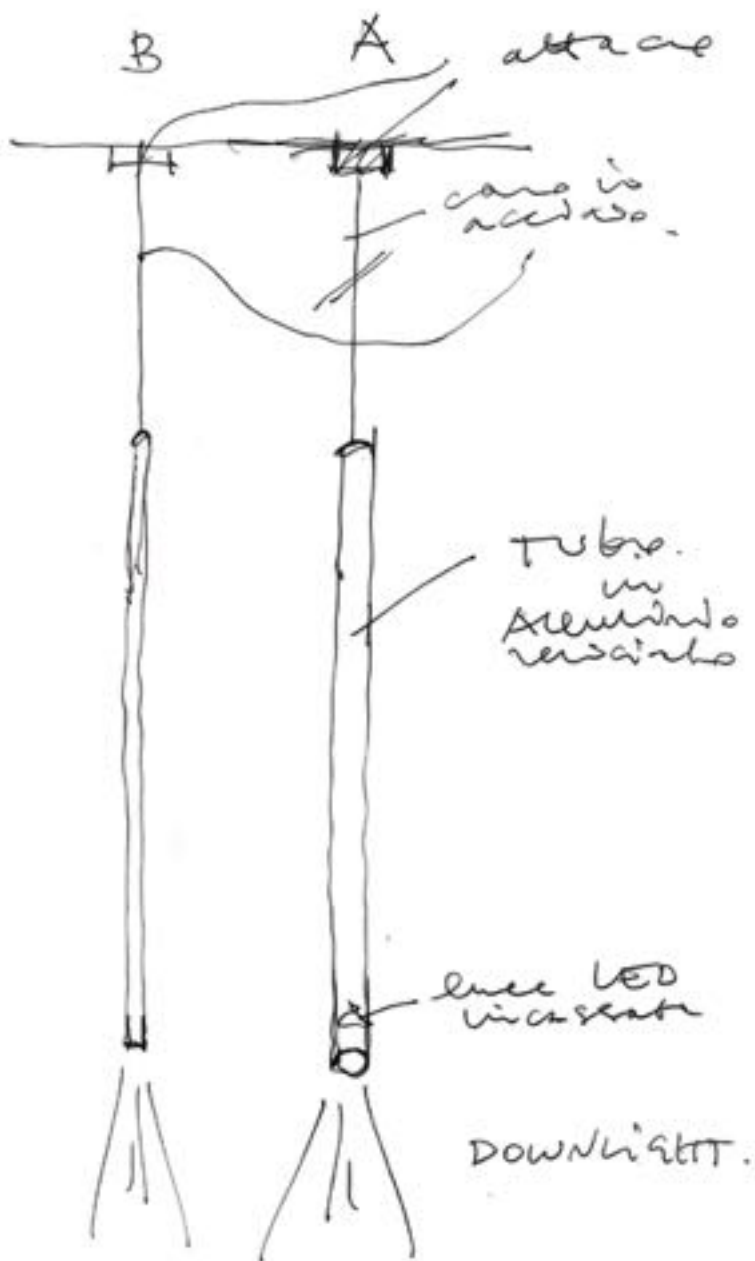

KOKO UNO

Koko è stata disegnata per il ristorante dal quale prende il nome; una luce che fosse al contempo funzionale e decorativa: in grado di esaltare i piatti e al tempo stesso rendere magica l'atmosfera del locale. Questa doppia anima si è sviluppata attraverso due diversi elementi: un cilindro in metallo lucido, che proietta una luce concentrata, ed uno in metacrilato trasparente, luminescente per tutta la sua lunghezza. Questi possono essere declinati in varie lunghezze, installati ad altezze diverse e combinati in molteplici configurazioni, da un'illuminazione puntuale fino ad una vera e propria pioggia di luce, realizzando effetti scenografici dinamici e contemporanei, per questa versione composta consultare il catalogo architectural.

Nelle pagine successive presentiamo Koko nella versione singola a sospensione. Disponibile anche nella versione a parete e a soffitto nella sezione dedicata del presente catalogo.

Koko was designed for the restaurant from which it takes its name; a light that was both functional and decorative: able to enhance the dishes and at the same time make the atmosphere of the restaurant magical. This double soul was developed through two different elements: a polished metal cylinder, which projects a concentrated light, and one in transparent methacrylate, luminescent along its entire length. These can be declined in various lengths, installed at different heights and combined in multiple configurations, from a specific lighting to a real shower of light, creating dynamic and contemporary scenic effects.

For this combined version see the architectural catalogue.

On the following pages we present Koko in the single metal pendant version.

Also available in wall and ceiling versions in the dedicated section of this catalogue.





KOKO UNO

PLS DESIGN - LORENZO PERINI
& EMILIANA MARTINELLI



Lampada a sospensione singola con rosone a luce diretta. Struttura in tubolare di alluminio in diverse finiture e misure. Per sorgente di luce a LED. Con alimentatore incluso nel rosone.

Single direct light suspension lamp with ceiling rose. Tubular aluminium structure in different finishes and sizes. For LED light source. With driver in the ceiling rose.

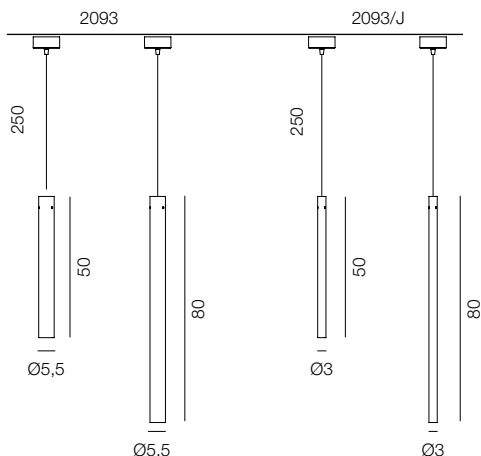

KOKO H80 Ø5,5
12W LED narrow 1230lm 3000K

- 2093/NE ● nero / black
- 2093/BI ○ bianco / white
- 2093/AU ● oro perlato / pearly gold
- 2093/CO ● corten / corten

KOKO H80 Ø3
4W LED narrow 420lm 3000K

- 2093/J/NE ● nero / black
- 2093/J/BI ○ bianco / white
- 2093/J/AU ● oro perlato / pearly gold
- 2093/J/CO ● corten / corten

KOKO H50 Ø5,5
12W LED narrow 1230lm 3000K

- 2093/50/NE ● nero / black
- 2093/50/BI ○ bianco / white
- 2093/50/AU ● oro perlato / pearly gold
- 2093/50/CO ● corten / corten

KOKO H50 Ø3
4W LED narrow 420lm 3000K

- 2093/J/50/NE ● nero / black
- 2093/J/50/BI ○ bianco / white
- 2093/J/50/AU ● oro perlato / pearly gold
- 2093/J/50/CO ● corten / corten





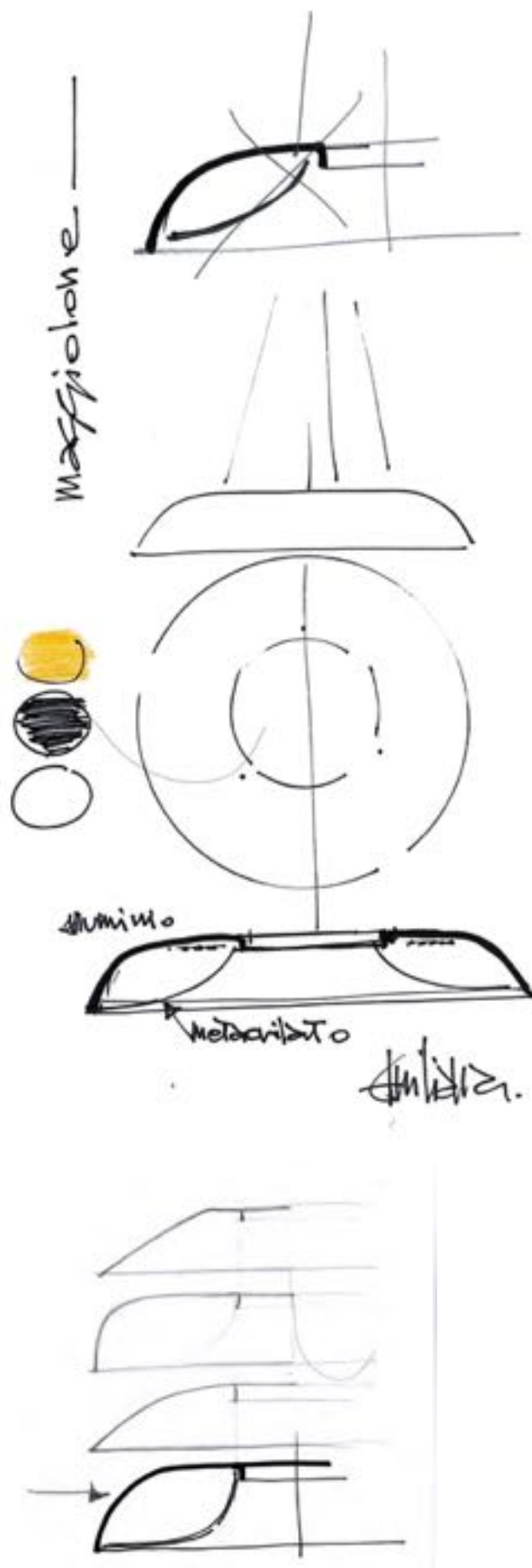

MAGGIOLONE

Una sospensione che da tempo pensavo di fare. Una grande lampada per il mio tavolo rotondo da pranzo. Poi, come succede spesso, faccio le prove di luce con gli amici a cena, cucino e... ritornano volentieri. Ho voluto nascondere la sorgente di luce con il diffusore, così che la lampada potesse essere sospesa non solo bassa sopra il piano ma anche più in alto, o al centro di una stanza per una luce ancora più diffusa. Il foro superiore, affinché la luce passando, oltre a rischiarare il soffitto, la rendesse ancora più leggera. Il giallo solare, un colore vivace per illuminare la stanza, ma in catalogo anche in bianco e nero.

A suspension lamp that I have been thinking about making for a long time. A large lamp designed to be placed on top of my round dining table and to replace a suspension lamp no longer in the catalogue. Then, as often happens, I test the lamp when I invite friends for dinner, I cook and... they happily return. I wanted to hide the light source with the diffuser, so that the lamp could be suspended not only low down over the top but also higher up, or in the middle of a room for even more diffused light. The hole at the top, so that the light passing through, as well as hitting the ceiling, would make it even lighter. Sunny yellow, a lively colour to light up the room, but also available in white and black.

EMILIANA MARTINELLI

MAGGIOLONE

EMILIANA MARTINELLI

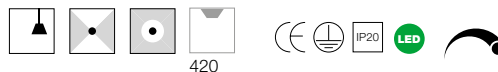

420

Lampada a sospensione, a luce diretta diffusa e indiretta. Struttura in alluminio verniciato nel colore bianco, nero o giallo. Diffusore in metacrilato opal bianco. Per sorgente di luce a LED. Alimentatore elettronico dimmerabile Push/Dali2 all'interno del rosone a soffitto. Disponibile in due dimensioni.

Suspension lamp, diffused direct and indirect light. Aluminium structure painted in white, black or yellow color. White opal methacrylate diffuser. For LED light source. Electronic dimmable Push/Dali2 driver inside the ceiling rose. Available in two sizes.

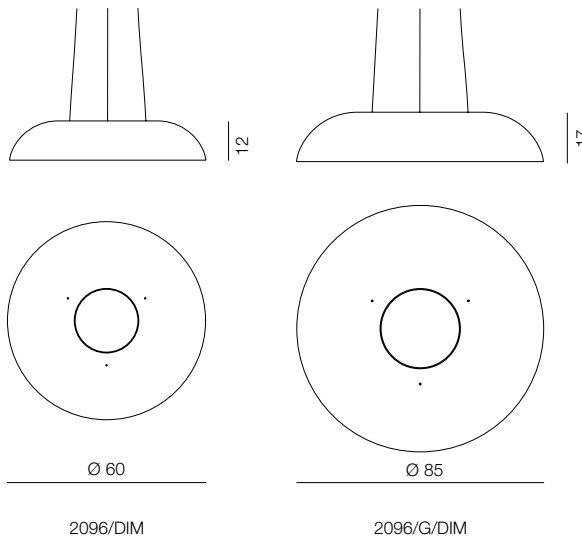

MAGGIOLONE Ø 60
26W LED 3200lm 2700K

- 2096/DIM/2700/BI ○ bianco / white
- 2096/DIM/2700/NE ● nero / black
- 2096/DIM/2700/GI ● giallo / yellow

MAGGIOLONE Ø 60
26W LED 3200lm 3000K

- 2096/DIM/BI ○ bianco / white
- 2096/DIM/NE ● nero / black
- 2096/DIM/GI ● giallo / yellow

MAGGIOLONE Ø 85
32W LED 4900lm 2700K

- 2096/G/DIM/2700/BI ○ bianco / white
- 2096/G/DIM/2700/NE ● nero / black
- 2096/G/DIM/2700/GI ● giallo / yellow

MAGGIOLONE Ø 85
32W LED 4900lm 3000K

- 2096/G/DIM/BI ○ bianco / white
- 2096/G/DIM/NE ● nero / black
- 2096/G/DIM/GI ● giallo / yellow





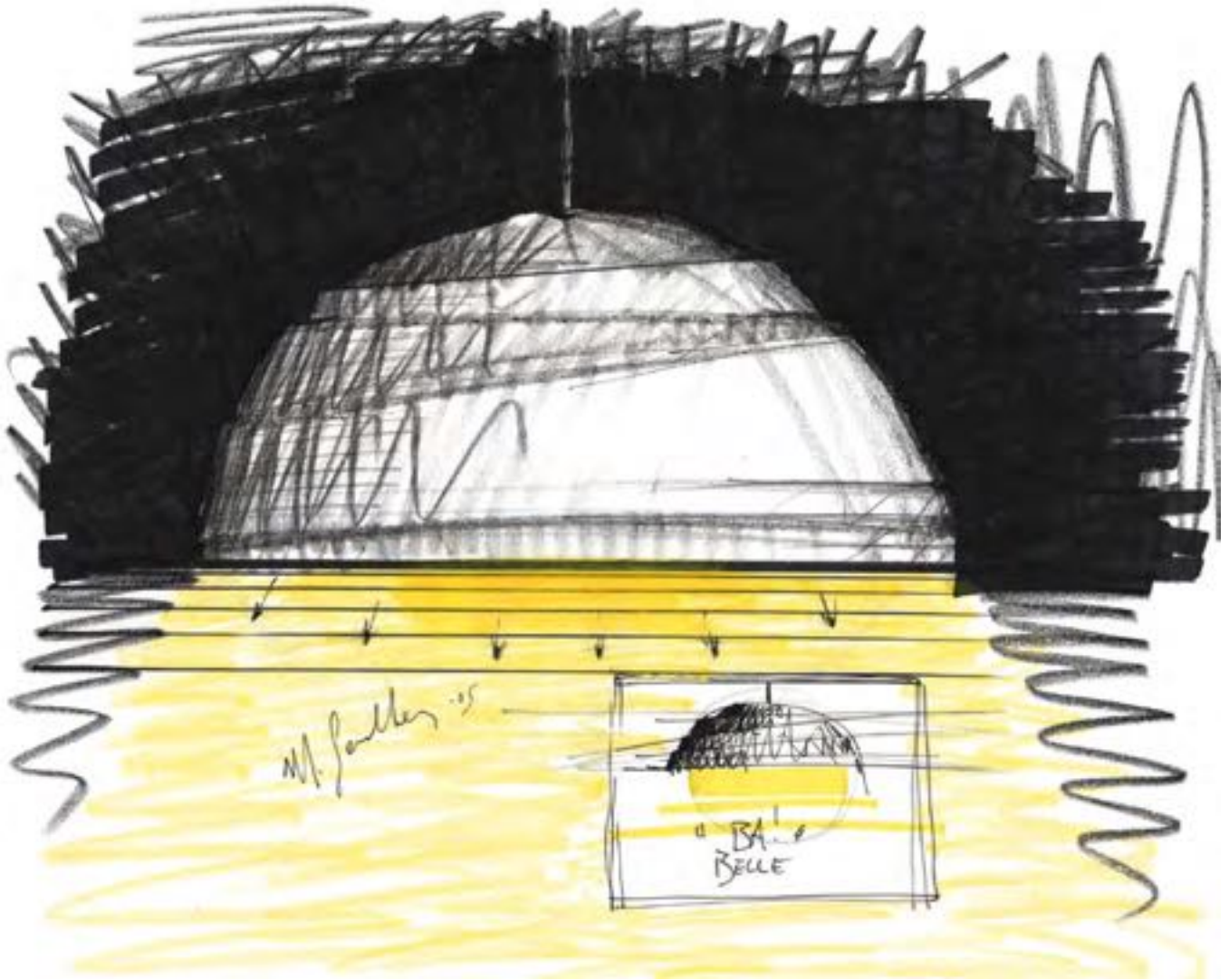

BABELE

Come la torre nella Bibbia punita per la presunzione di voler toccare il cielo da cui è cominciata la profusione di lingue diverse che ha impedito agli uomini di comunicare tra loro. Invece Babele è una bella "campana" che sembra forgiata a mano e che raccoglie sotto di sé nuove forme di moderna convivialità.

Like the tower in the Bible, punished for the presumption of wanting to touch the sky, from which began the profusion of different languages that made it impossible for men to communicate with each other. Babele, on the contrary, is a beautiful "bell" that seems to have been forged by hand and that gathers underneath it new forms of modern conviviality.

MARC SADLER





BABELE

MARC SADLER



Lampada a sospensione a luce diretta.
Struttura in alluminio verniciato nel colore micaceo tamponato in modo non uniforme, con interno verniciato nel colore oro.
Disponibile in tre dimensioni.
Per lampada a LED.

Suspension lamp direct light. Aluminium structure in micaceous colour not uniformly painted, internal finishing in gold painted colour. Available in 3 sizes.
For LED bulbs.

BABELE Ø 92
3x15W E27 LED

2040/SD ● micaceo / micaceous

BABELE Ø 65
1x15W E27 LED

2040/65/SD ● micaceo / micaceous

BABELE Ø 45
1x15W E27 LED

2040/J ● micaceo / micaceous

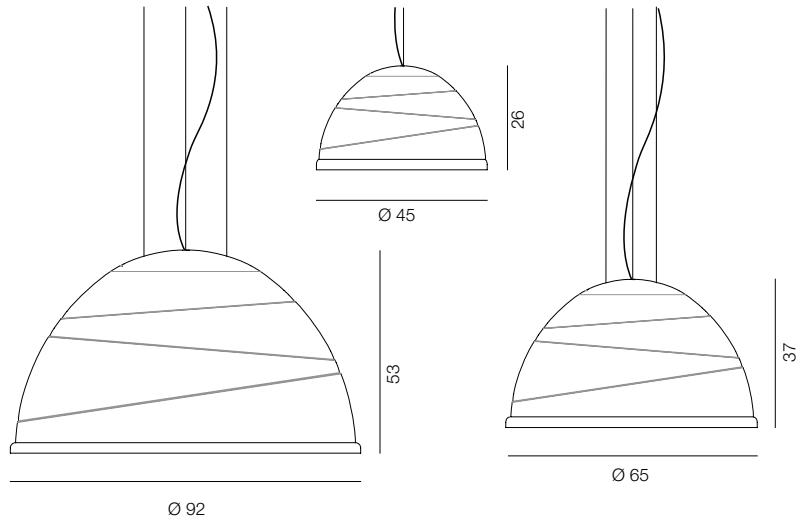



Multino Urbano, Salerno, arch. Francesco Rizzo





BUBBLES

Bubbles è una semplice semisfera sospesa che diffonde una luce piacevole e rallegra l'ambiente in cui viene inserita con i colori della primavera: il giallo, l'arancio, il blu ed il classico bianco. Realizzata in metacrilato satinato colorato è disponibile in due dimensioni.

Bubbles is a simple suspended hemisphere that diffuses a pleasant light and brightens up the environment in which it is placed with the colours of spring: yellow, orange, blue and classic white. It is made of coloured satin methacrylate and it is available in two sizes.

ELIO & EMILIANA MARTINELLI

BUBBLES

ELIO & EMILIANA MARTINELLI



Lampada a sospensione a luce diffusa.
Diffusore in metacrilato nei colori bianco lucido, blu satinato, giallo satinato e arancio satinato.
Supporto in metallo verniciato nel colore nero. Per lampadina a LED sferica.
Disponibile in due misure.

Suspension lamp diffused light.
Methacrylate diffuser in the colours glossy white, satin blue, satin yellow and satin orange.
Metal support painted in black.
For spherical LED bulb.
Available in two sizes.

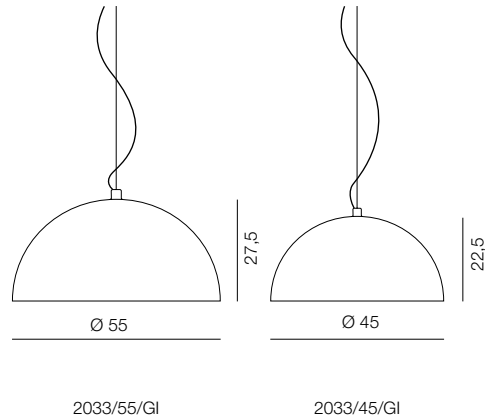

BUBBLES Ø 55
1x15W E27 R95 LED

2033/55/C/BI ○ bianco lucido / glossy white

BUBBLES Ø 45
1x15W E27 R95 LED

2033/45/C/BI ○ bianco lucido / glossy white

2033/45/C/BL ● blu satinato / satin blue

2033/45/C/GI ● giallo satinato / satin yellow

2033/45/C/AR ● arancio satinato / satin orange



NUVOLE VAGABONDE

ELIO & EMILIANA MARTINELLI



Lampada a sospensione a luce diffusa.
Struttura portante in metallo verniciato
nel colore bianco, con elementi diffusori
sovrapposti a incastro stampati in
policarbonato opal bianco.
Per lampadina a LED.
Disponibile in altri diametri vedi catalogo
architectural.

Suspension lamp diffused light. Frame in
white painted metal, superimposed diffuser
elements in white opal polycarbonate.
For LED bulb.
Aivalable in other diameters see
architectural catalogue.

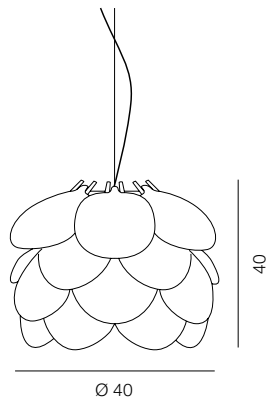

1x15W E27 LED

2011J ○ bianco / white





CUPOLONE

ELIO MARTINELLI



Lampada a sospensione a luce diretta.
Struttura in alluminio formata da cinque
elementi distanziati e sovrapposti così da
far filtrare la luce, fissati con pomellini,
verniciata nel colore bianco o dorato.
Per lampadina a LED.

Suspension lamp direct light. Aluminium
structure made up of five elements spaced
and superimposed so as to let the light filter
through, fixed with knobs, painted white or
golden.
For LED bulb.

1x15W E27 LED

1889  bianco / white

1889/AU  dorato / golden

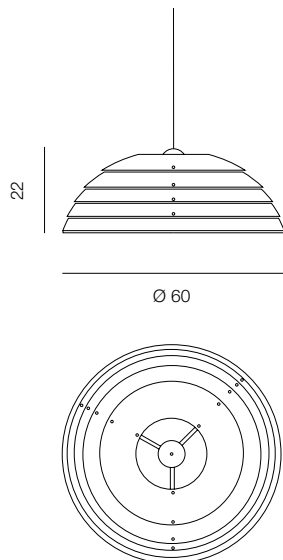



CONO

ELIO MARTINELLI



Lampada a sospensione a luce diretta, in alluminio verniciato nel colore bianco, nero, azzurro o rosso. Riflettore interno in alluminio verniciato nel colore bianco. In due dimensioni. Per lampadina a LED.

Suspension lamp direct light, in white, black, light blue, or red painted aluminium structure. Internal aluminium reflector painted in white. In two sizes. For LED bulb.

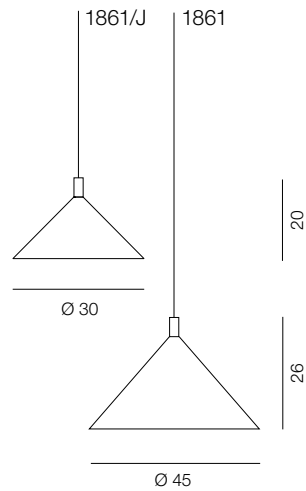

CONO Ø45
1x15W E27 LED

- 1861/BI  bianco / white
- 1861/NE  nero / black
- 1861/AZ  blu / blue
- 1861/RO  rosso / red

CONO Ø30
1x10W E27 LED

- 1861/J/BI  bianco / white
- 1861/J/NE  nero / black
- 1861/J/AZ  blu / blue
- 1861/J/RO  rosso / red



BLOW

ELIO MARTINELLI



Una grande semisfera a sospensione a luce diffusa. Diffusore in metacrilato opal bianco. Particolare di attacco e rosone in metallo verniciato nel colore bianco. Per lampadina a LED.

A large suspension hemisphere with diffused light. White opal methacrylate diffuser. Detail and ceiling rose in white painted metal. For LED bulb.

1x15W E27 LED

1858 ○ bianco / white

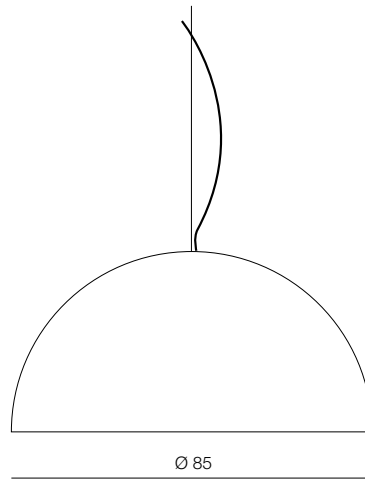



Schöner
Social Kitchen



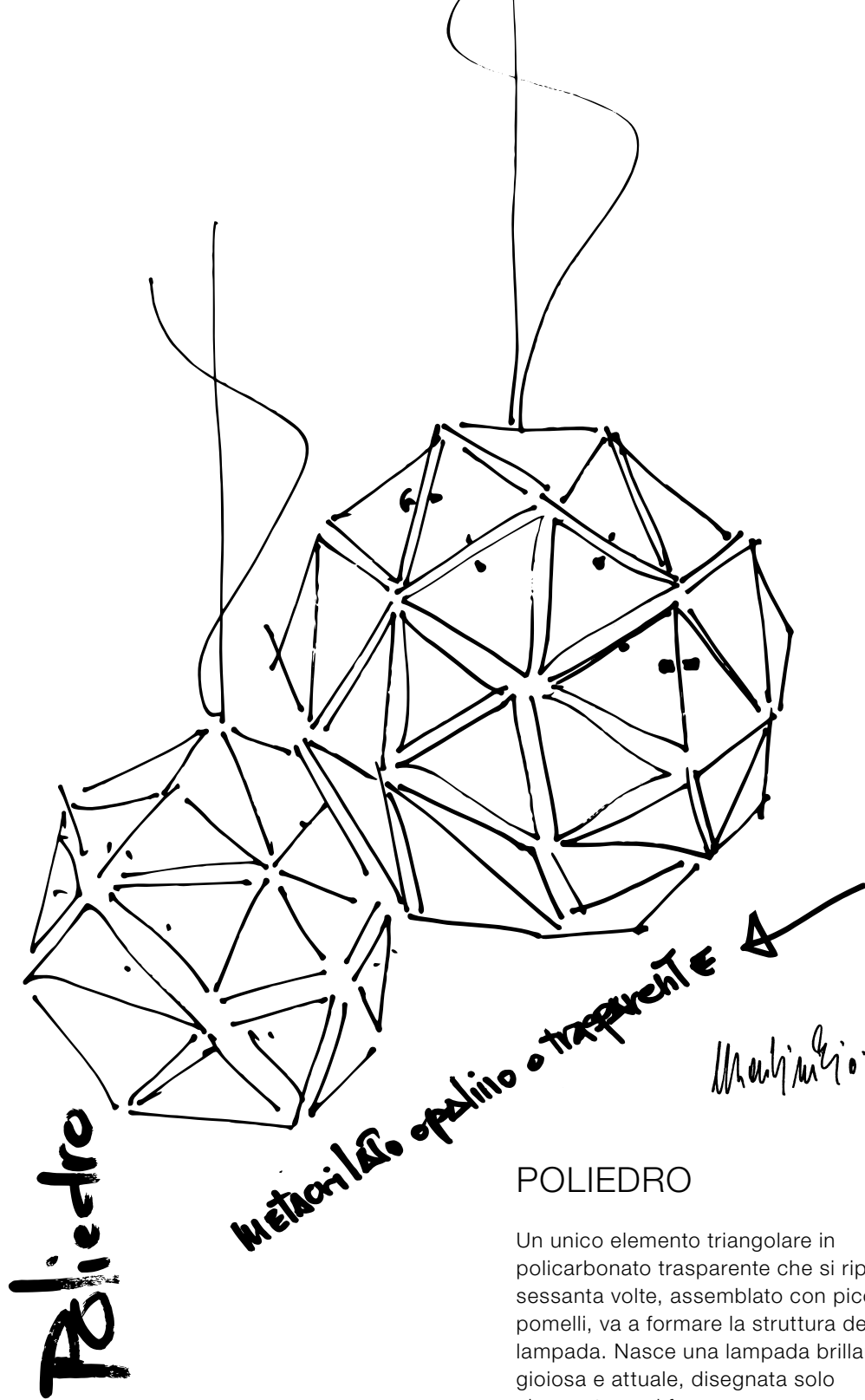

POLIEDRO

Un unico elemento triangolare in policarbonato trasparente che si ripete sessanta volte, assemblato con piccoli pomelli, va a formare la struttura della lampada. Nasce una lampada brillante, gioiosa e attuale, disegnata solo cinquanta anni fa.

One single triangular element made of transparent polycarbonate that recurs sixty times, assembled with small knobs, forms the lamp frame. It results a bright, joyful and fashionable lamp that has been designed just fifty years ago.

ELIO MARTINELLI





POLIEDRO

ELIO MARTINELLI



Lampada a sospensione a luce diffusa, sospesa con cavo in acciaio. Struttura di attacco in metallo cromato. Diffusore formato da sessanta moduli uguali a triangolo, stampati in policarbonato trasparente, fissati tra di loro con pomellini a vite trasparenti, così da formare una sfera. Per lampadina a LED.

Suspension lamp with diffused light. Hanged by a steel cable. Frame of connection in chromed metal. Diffuser consisting of 60 triangles shaped identical modules, in transparent polycarbonate and fixed among each other by transparent screws, so as to form a sphere. For LED bulb.

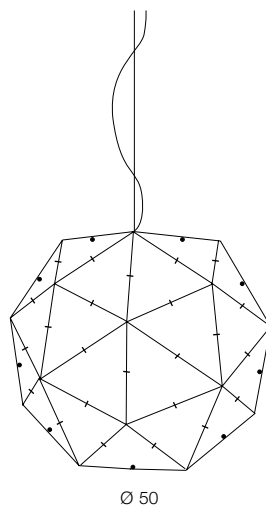

1x16W E27 R95 LED

1722  trasparente / transparent





LAMPADE DA TERRA FLOOR LAMPS



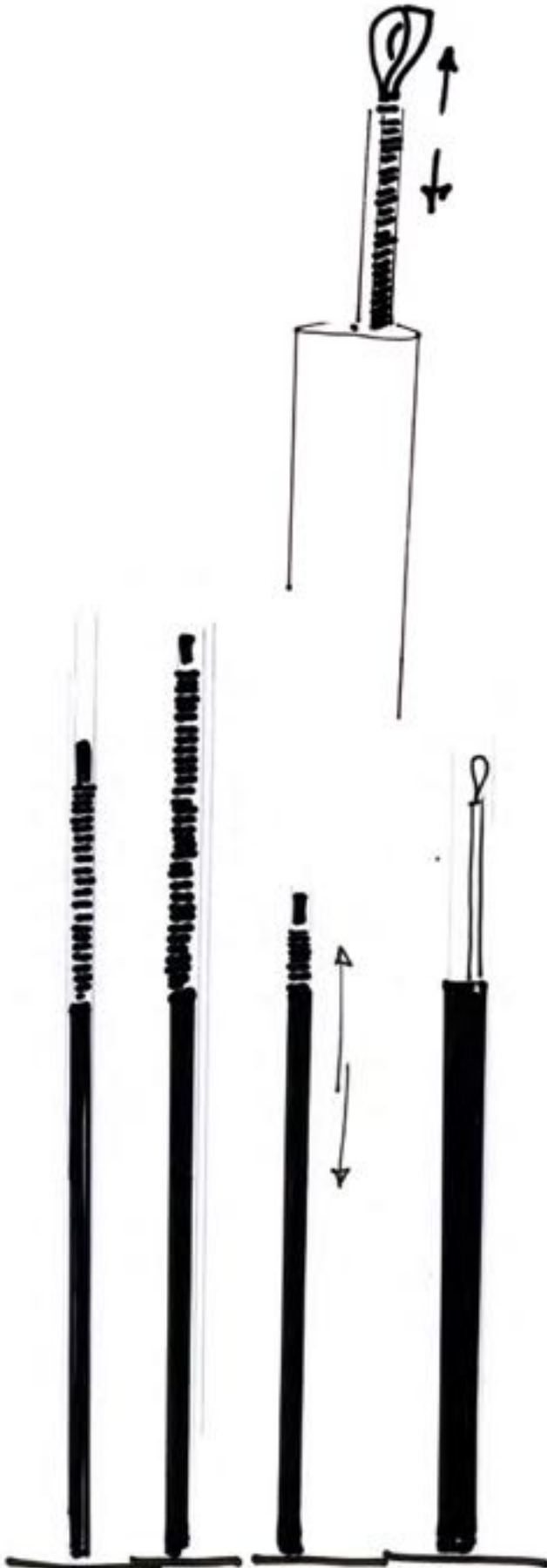

METRICA

Metrica da terra è la lampada ideale nella zona living, emette una luce diretta nell'ambiente direzionando la luce verso la parete evitando l'abbagliamento diretto. È caratterizzata da un corpo lucido dall'altezza di 86,5 cm, di colore nero o bianco, poggiato su una base circolare bianca lucida. La sorgente di luce a LED della lunghezza di 50 cm è nascosta all'interno del supporto che forma la base, si accende nel momento in cui viene estratta, aumentando progressivamente di intensità fino a raggiungere la posizione massima.

Metrica floor lamp is the ideal lamp in the living area, it emits a direct light in the environment by directing the light towards the wall avoiding direct glare. It is characterised by a polished black or white body with a height of 86.5 cm, resting on a polished white circular base. The 50 cm long LED light source is hidden inside the support that forms the base, it lights up as soon as it is extracted, gradually increasing in intensity until it reaches its maximum position.

STUDIO HABITS

METRICA

STUDIO HABITS



44 378

Lampada da terra a luce diretta che si accende e si spegne quando la sorgente di luce a LED viene estratta o riposizionata all'interno del corpo lampada.

Struttura in alluminio estruso verniciato nel colore bianco o nero, base nel colore bianco.

Alimentatore a spina.

Direct light floor lamp that switches on and off when the LED light source is removed or repositioned inside the lamp body.

Extruded aluminium frame painted in white or black, base in white.

Driver on plug.

15W LED 850lm 3000K

2314/BI  bianco / white

2314/NE  nero / black

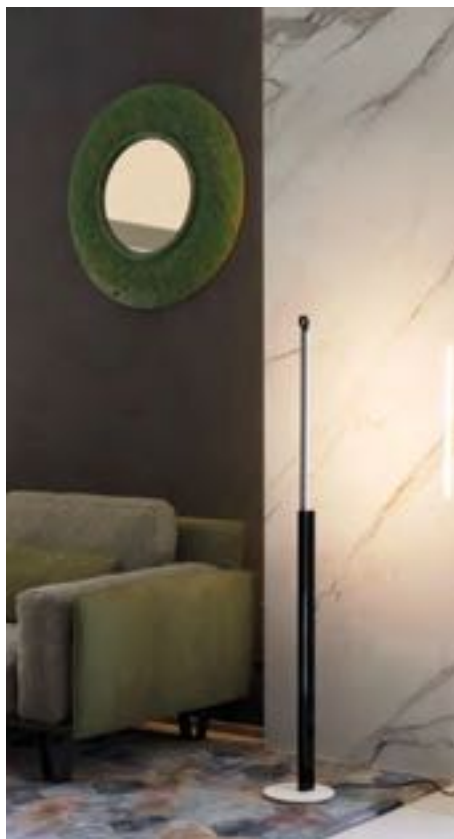
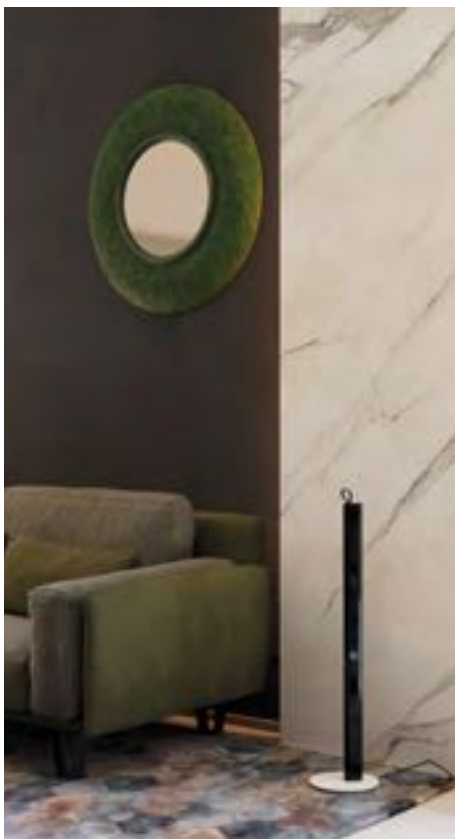
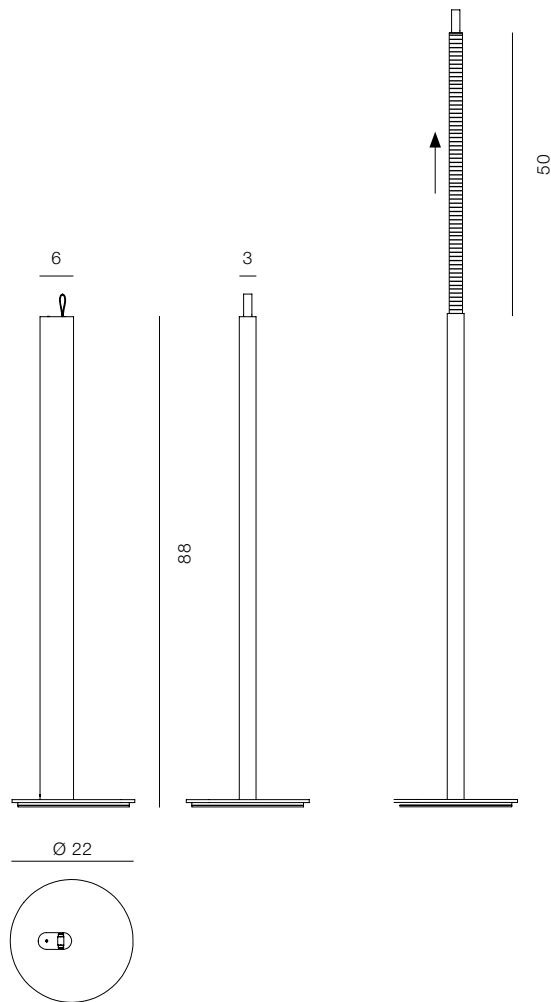





DIA

Un esile e trasparente torre di vetro si erge alta. Due LED con accensione indipendente proiettano la luce in basso e verso il soffitto. Il dissipatore sembra fluttuare nell'aria, collegato alla base dai due sottili cavi di alimentazione tesi, che contribuiscono alla stabilità della struttura e caratterizzano il progetto.

A thin, transparent glass tower rises high. Two independently switched LEDs project light downwards and towards the ceiling. The heat sink seems to float in the air, connected to the base by two thin, stretched power cables that provide stability to the structure and characterise the design.

SIMON SCHMITZ

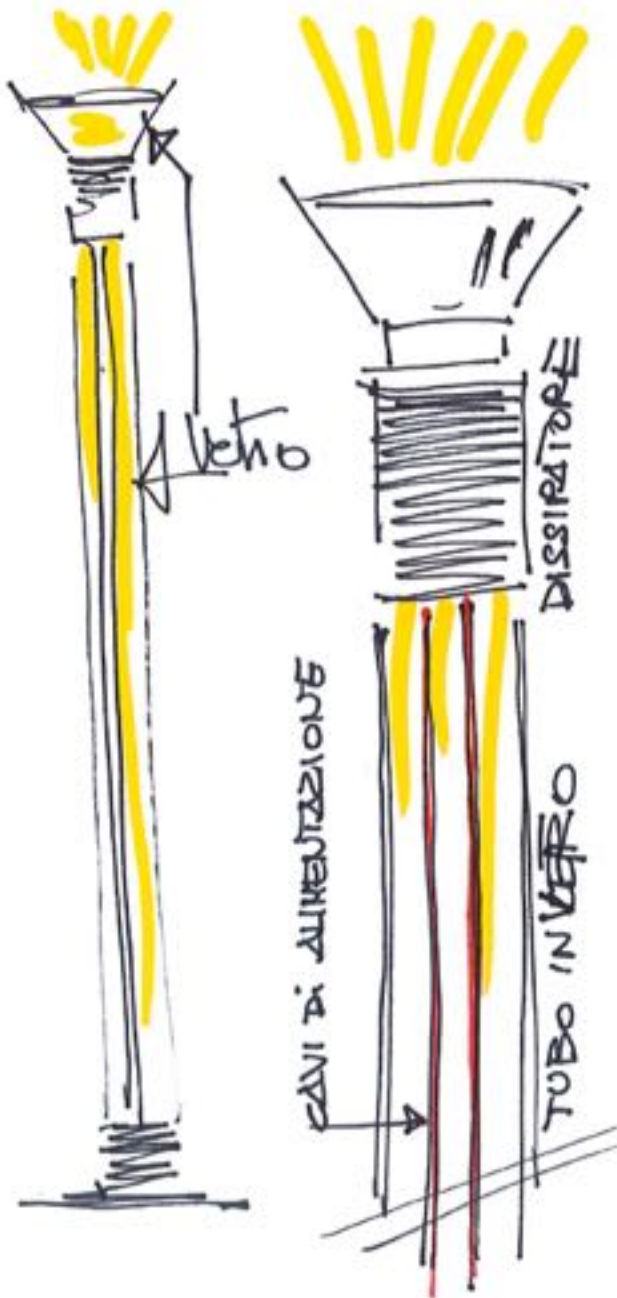





DIA

SIMON SCHMITZ



Lampada da terra a luce diretta e indiretta con doppia accensione.
Struttura in vetro trasparente con dissipatore e cavi di alimentazione a vista.
Sorgente di luce a LED.
Alimentatore a spina.

Floor lamp providing direct and indirect light with dual ignition.
Transparent glass structure with visible heat sink and power cables.
LED light source.
Driver on plug.

9W LED 1060lm 2700K
luce diretta / direct light
+
9W LED 1060lm 2700K
luce indiretta / indirect light

2317  trasparente / transparent

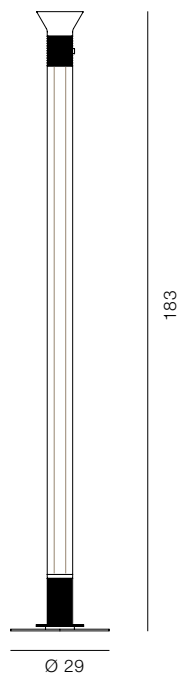





GRU

Gru è una lampada diversa e originale perché non si può classificare né come lampada da parete né da terra, è entrambe.

È un oggetto che semplicemente si appoggia al muro e può essere spostato con facilità, non solo per la sua fine silhouette, ma anche per il suo peso piuma.

La quotidianità, oggi, trasformatasi in multifunzionale ed ibrida, con Gru diventa ancora più comoda.

La lampada ha una doppia emissione di luce: diretta/indiretta a LED lineari con accensione separata a pulsante sul corpo lampada.

Gru (crane) is a different and original lamp because it cannot be classified as either a wall or floor lamp, it is both.

It is an object that simply rests on the wall and can be moved with ease, not only because of its slim silhouette, but also because of its featherweight.

The daily life, now multifunctional and hybrid, becomes even more convenient with Gru.

The lamp has a dual light emission: direct/indirect linear LEDs with separate push-button switching on the lamp body.

DAVIDE FRATTINI FRILLI

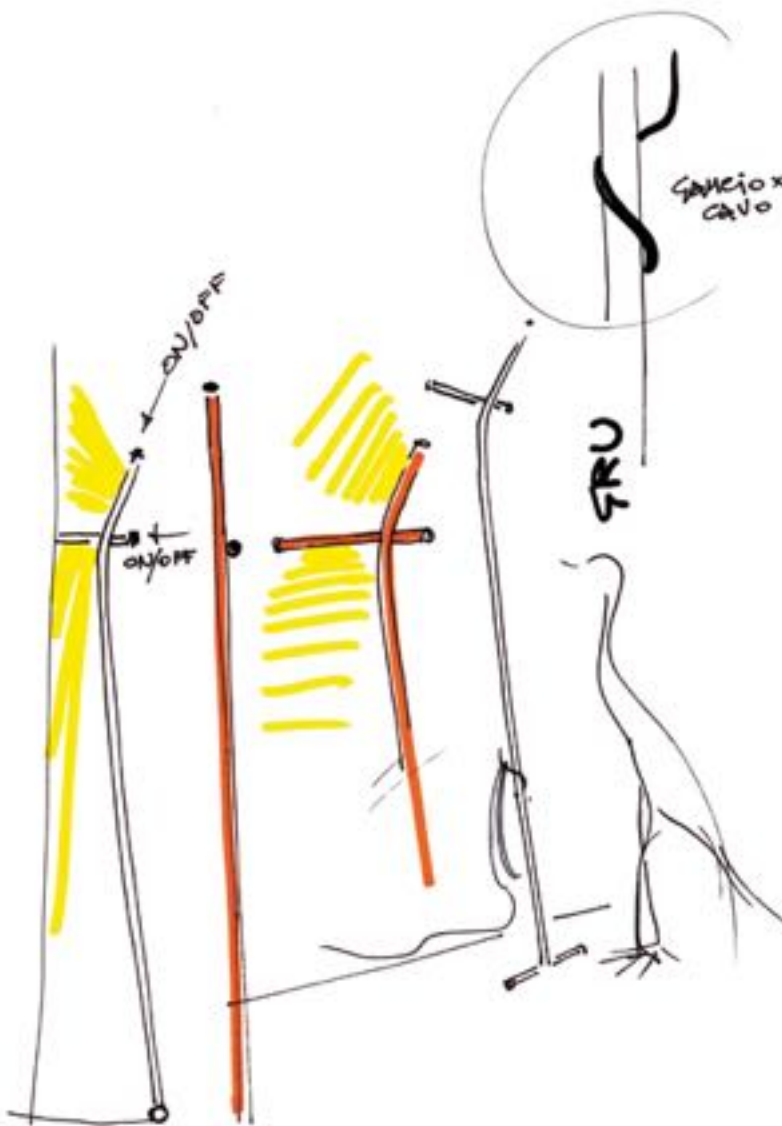

GRU

DAVIDE FRATTINI FRILLI



Lampada da terra da appoggiare alla parete a luce diretta e indiretta con doppia accensione.

Struttura in metallo verniciato nei colori nero, arancio e verde.

Sorgente di luce a LED, alimentatore a spina.

Wall-mounted floor lamp providing direct and indirect light with dual ignition.
Metal structure painted in black, orange and green.
LED light source, plug-in driver.

3,2W LED 370lm 2700K

luce diretta / direct light

+

6,4W LED 740lm 2700K

luce indiretta / indirect light

2316/NE ● nero / black

2316/AR ● arancio / orange

2316/VE ● verde / green

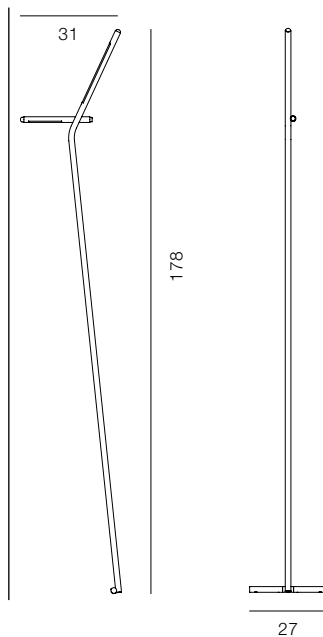





CABRIOLETTE

Piccola, orientabile, funzionale, rotonda e giocosa.

Una testa orientabile a luce diretta e diffusa per illuminare e creare vari effetti di luce sulla parete.

Disponibile nella versione da tavolo, nella versione cordless e da parete.

Small, adjustable, functional, circular and playful.

A swivelling head with direct and diffuse light for illuminating and creating various lighting effects on the wall.

Available in table, cordless and wall-mounted versions.

STUDIO NATURAL

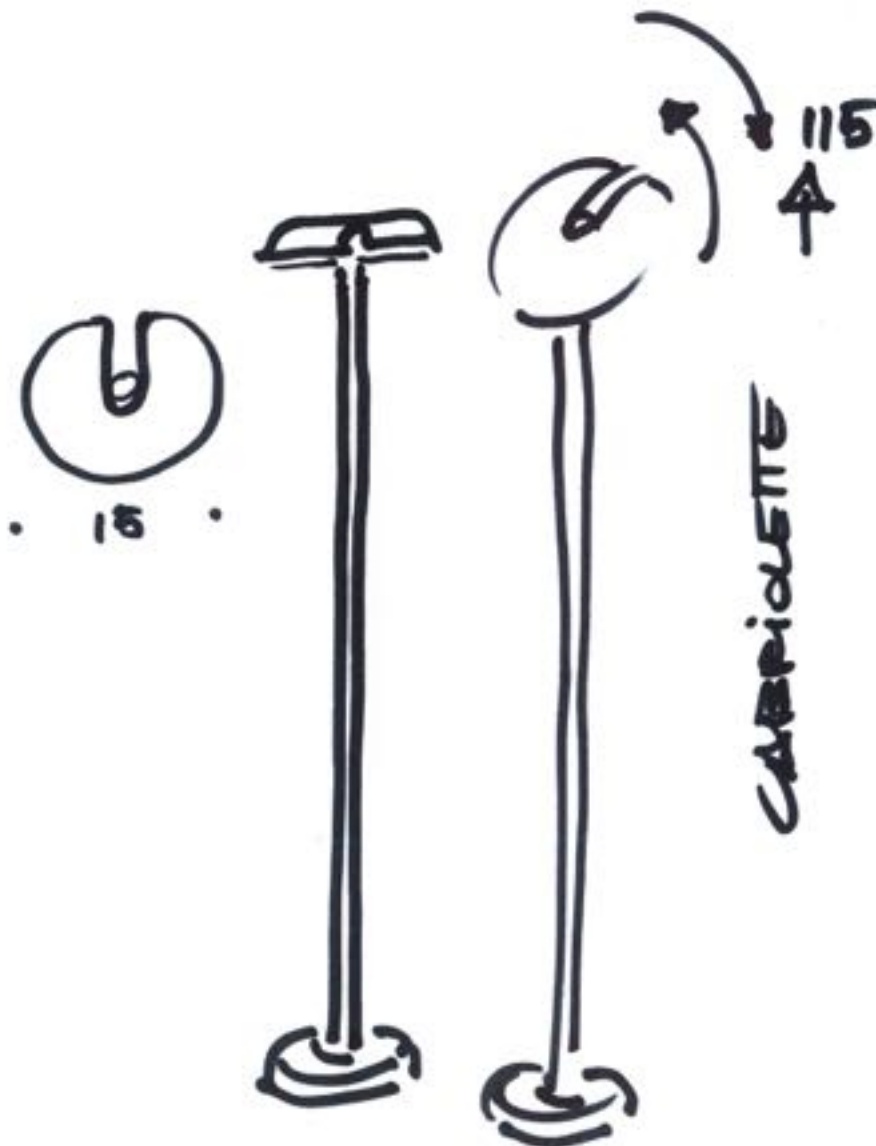





CABRIOLETTE

STUDIO NATURAL

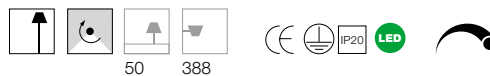

50 388

Lampada da terra a luce diretta orientabile.
Struttura in pressofusione di alluminio verniciato nei colori bianco, nero, giallo e azzurro.
Diffusore in policarbonato opal bianco.
Sorgente di luce a LED integrato.
Dimmerabile con pulsante sul cavo.
Alimentatore a spina.

Floor lamp providing direct adjustable light.
Aluminium die-cast structure painted in white, black, yellow and light blue.
White opal methacrylate diffuser.
Integrated LED light source.
Dimmable with button on cable.
Driver on the plug.

14W 2200lm 2700K

2319/BI ○ bianco / white

2319/NE ● nero / black

2319/GI ● giallo / yellow

2319/AZ ● azzurro / light blue

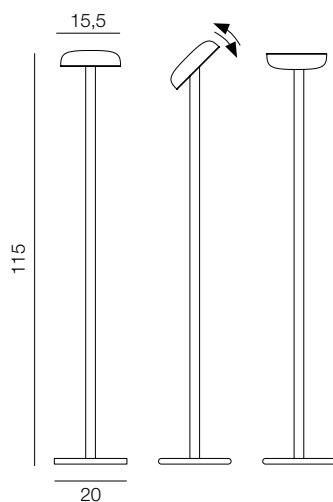





FROG

Una lampada nata nel periodo della pandemia. Ero a casa in campagna e la sera, a parte certe zone illuminate nel prato, i cespugli erano al buio. È così che ho pensato a una lampada mobile, facile da spostare, orientabile, di carattere per poter facilmente illuminare oggi una pianta, domani un altro angolo del giardino o della terrazza e, se necessario, portarla anche in casa. Ho pensato alla sua forma come un proiettore realizzato poi in polietilene con tecnica rotazionale, una tecnologia insolita per questo tipo di lampada. Allegra con dei colori decisi come il giallo, l'arancio, l'ottanio e l'antracite. La base in alluminio permette di appoggiarla sul prato, sopra un mobile o sul pavimento di casa, ma anche fissarla a parete, così da illuminare dove e cosa vogliamo.

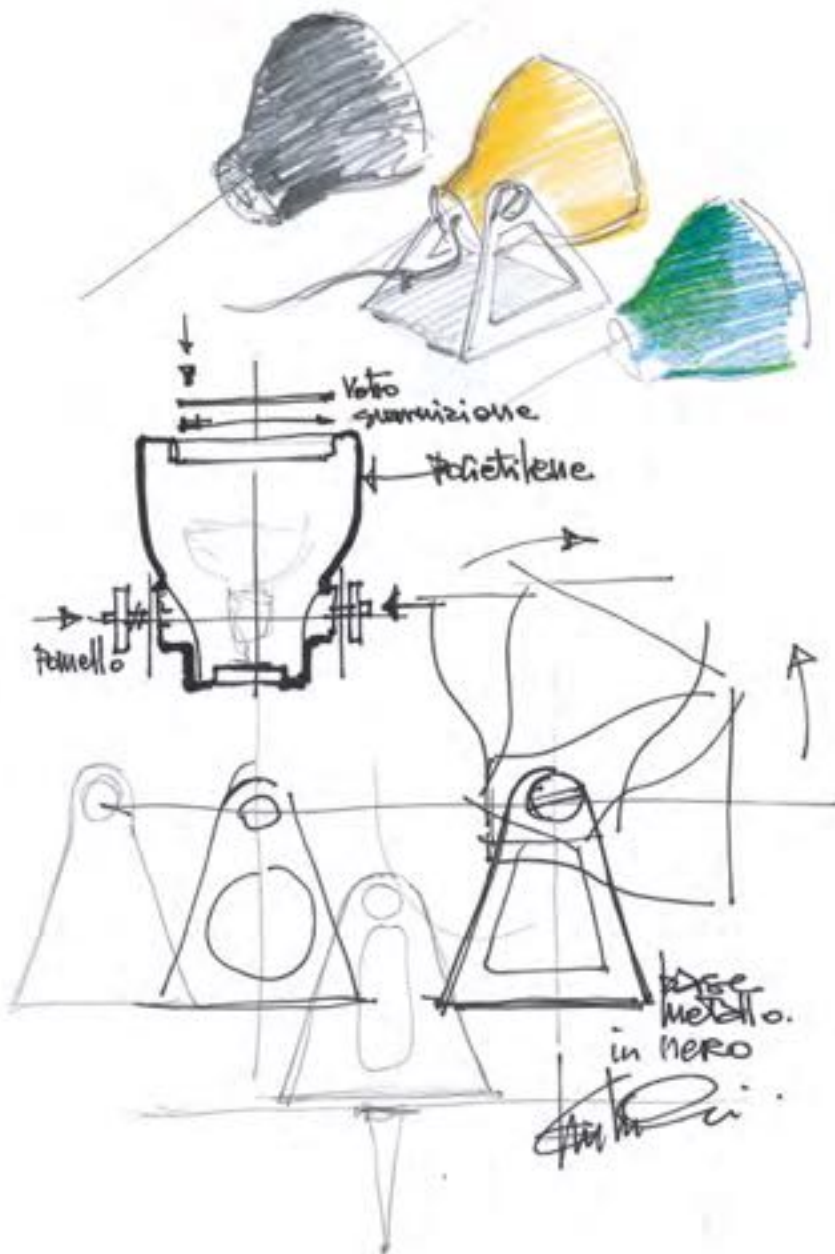

A lamp born in the period of the pandemic. I was at home in the countryside and in the evening, apart from certain illuminated areas in the meadow, the bushes were dark. That's how I came up with the idea of a portable lamp, easy to move, adjustable, with character, so that it can easily light up a plant today, another corner of the garden or terrace tomorrow and, if necessary, take it into the house. I thought of its shape as a spotlight then made of polyethylene using the rotational technique, an unusual technology for this type of lamp. Cheerful with bold colours such as yellow, orange, octane blue and anthracite. The aluminium base allows it to be placed on the lawn, on top of a piece of furniture or on the floor of the house, but it can also be fixed to the wall, so that it can be illuminated where and what we want.

EMILIANA MARTINELLI







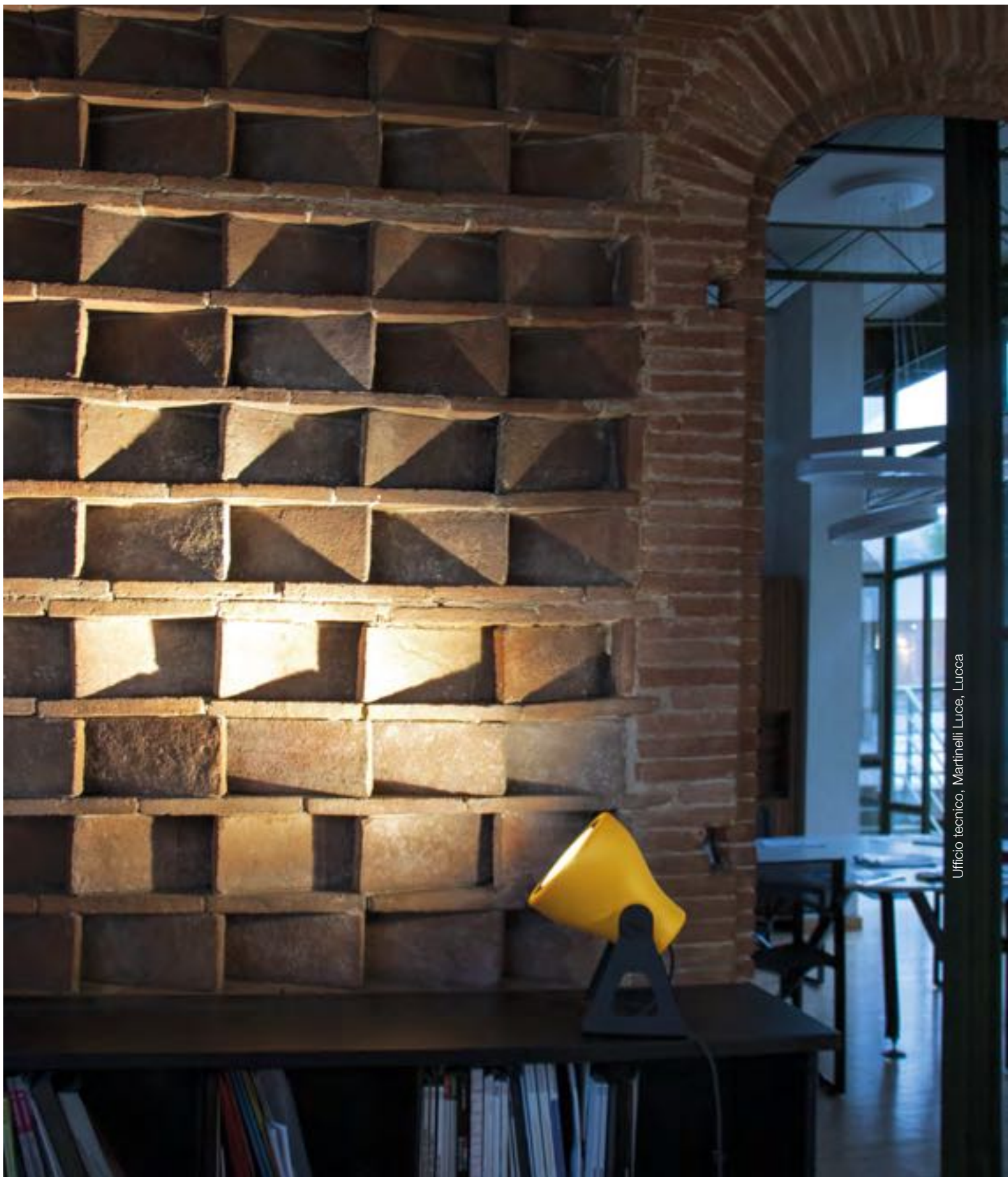

FROG

EMILIANA MARTINELLI



Lampada da esterno o interno a luce diretta orientabile. Da spostare liberamente grazie alla base di appoggio in alluminio verniciato nel colore nero. Corpo lampada stampato con tecnologia rotazionale in polietilene nei colori: giallo, arancio e blu ottanio. Diffusore in policarbonato. Per lampadina a LED.

Outdoor or indoor lamp with adjustable direct light. With black painted aluminium base. Body lamp moulded in polyethylene with rotational technology in the colours: yellow, orange and octane blue. Polycarbonate diffuser. For LED bulb.

20W E27 PAR 38

2309/GI  giallo / yellow

2309/AR  arancio / orange

2309/BL  blu ottanio / octane blue

LAMPADINE / BULBS

510X 20W E27 PAR38 45° LED 1910lm 3000K

511X 14W E27 PAR38 75° LED 1400lm 3000K



LAMPADINA RGB-W / RGB-W BULB

513Y 20W E27 PAR38 45° LED RGB-W
con telecomando / with remote control

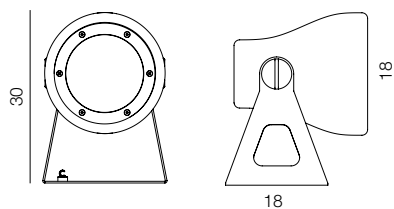



MINIFROG

EMILIANA MARTINELLI



Lampada da esterno o interno a luce diretta orientabile. Da spostare liberamente grazie alla base di appoggio in alluminio verniciato nel colore nero. Corpo lampada stampato con tecnologia rotazionale in polietilene nei colori: giallo, arancio e blu ottanio. Diffusore in policarbonato. Per lampadina a LED.

Outdoor or indoor lamp with adjustable direct light. With black painted aluminium base. Body lamp moulded in polyethylene with rotational technology in the colours: yellow, orange and octane blue. Polycarbonate diffuser. For LED bulb.

7W GU10

2309/J/GI  giallo / yellow

2309/J/AR  arancio / orange

2309/J/BL  blu ottanio / octane blue

LAMPADINE / BULBS

541Y 7W GU10 60° LED 610lm 2700K

542Y 4,5W GU10 38° LED 355lm 2700K

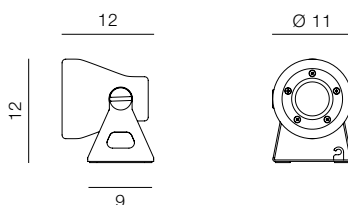





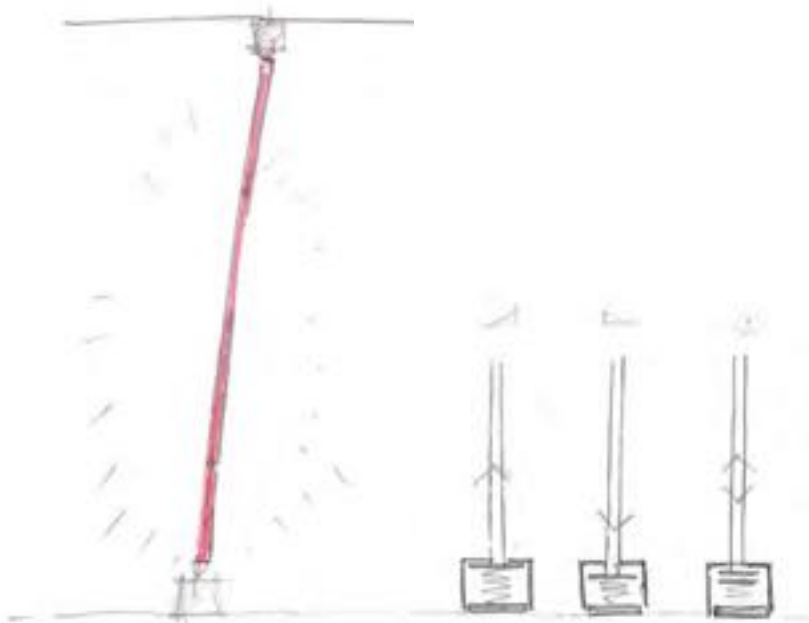
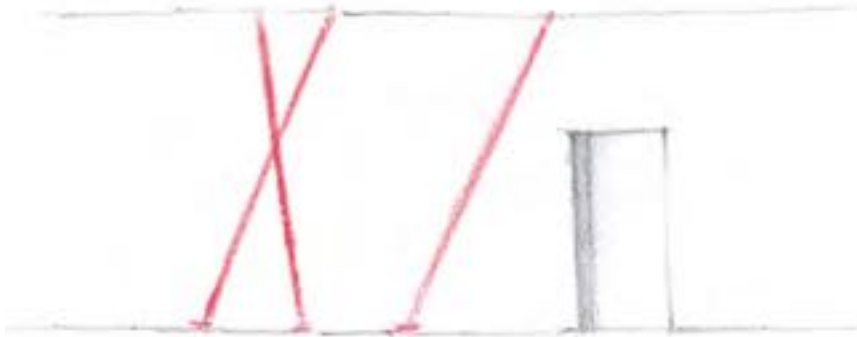
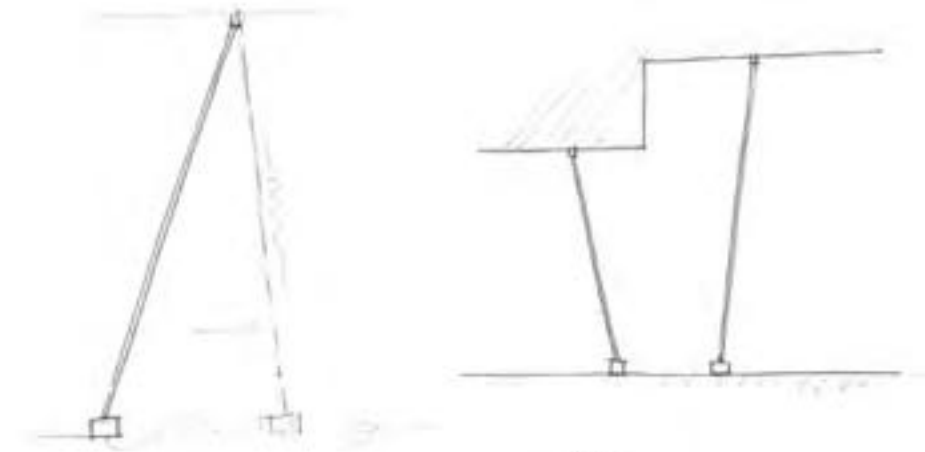

ELASTICA

L'idea di Elastica è nata in modo sperimentale... Una sera nel fablab dello studio, sommersi dai prototipi in allestimento per la partecipazione al Fuorisalone presso Super Studio, ne osservavamo uno in particolare. Da tempo avevamo tentato di mettere a punto una lampada tessile terracielo. Avevamo rocchetti di elastici per bretelle usati per il prototipo terracielo e pensando a come sfruttarne le proprietà meccaniche abbiamo pensato che l'elasticità potesse diventare una metafora dell'intensità per una innovativa esperienza di modulazione della luminosità. L'indomani ci siamo procurati un sensore di forza, un board per la prototipazione elettronica, una striscia LED e l'elastico, appunto.

The idea of Elastica was born in an experimental way... On an evening in the studio's fablab, overwhelmed by prototypes being prepared for participation in the Fuorisalone at Super Studio, we were looking at one in particular. For a long time we had been trying to develop a ground-sky textile lamp. We had spools of elastic braces used for the ground-sky prototype and were thinking about how to exploit their mechanical properties. We thought that elasticity could become a metaphor for intensity in an innovative light modulation experience. The next day we got a force sensor, a board for electronic prototyping, a LED strip and the elastic band, indeed.







312



ELASTICA

STUDIO HABITS



380

Una lampada a luce indiretta/diretta. Una striscia in tessuto di vari colori tesa tra soffitto e pavimento completa di una strip flessibile LED che la percorre nella sua lunghezza. Un particolare circuito elettronico e un sensore di forza permettono, attraverso un piccolo movimento "pull and release", di accendere e spegnere Elastica, mentre, con un movimento lento di estensione sul tessuto elastico verso l'alto o verso il basso è possibile aumentare e diminuire l'intensità luminosa. La striscia elastica è fissata alla base di contrappeso e all'altra estremità ad un supporto da fissare al soffitto. È possibile regolare la lunghezza della striscia per permettere il suo posizionamento in ambienti con soffitti di varie altezze da H250 a H320. Con cavo e alimentatore elettronico dimmerabile a spina.

A lamp with indirect/direct light. A multi-coloured fabric strip stretched between ceiling and floor complete with a flexible LED strip that runs the length of the strip. A special electronic circuit and a force sensor make it possible, through a small "pull and release" movement, to switch Elastica on and off, while, with a slow upward or downward extension movement on the elastic fabric, it is possible to increase or decrease the light intensity. The elastic strip is attached to the counterweight base and at the other end to a support to be fixed to the ceiling. The length of the strip can be adjusted to allow it to be positioned in environments with various ceiling heights from H250 to H320. With cable and dimmable electronic plug-in power supply.

17W LED 1775lm 2700K

2301/GR ● grigio / grey

2301/RO ● rosso / red

2301/NE ● nero / black

2301/GI ● giallo / yellow

2301/AZ ● azzurro / light blue

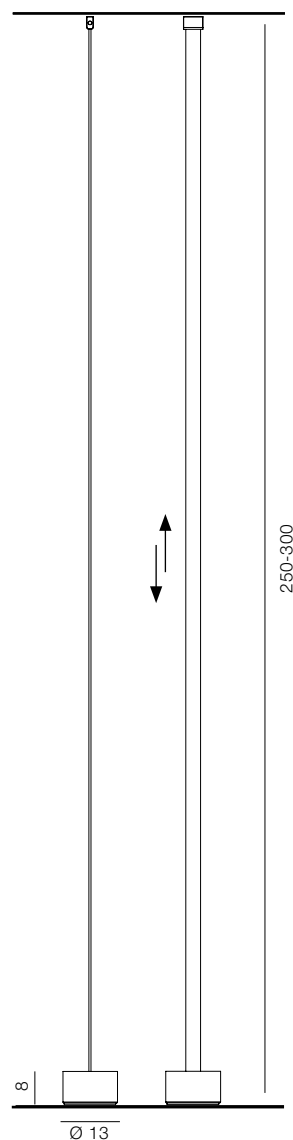

314







Y3

Molte torri di trasmissione sono tenute in posizione da spessi fili d'acciaio, che ne sostengono il peso da tre diverse direzioni, tenendo la esile torre in posizione. Cosa succede se si aggiunge la libertà di movimento al mix? Tre corde caricate a molla formano un meccanismo completo, permettendo all'asta Y3 di muoversi liberamente e senza sforzo in qualsiasi direzione possibile. Un balletto di molle che si allungano e si contraggono, che facilitano il suo spostamento lungo la base con un movimento verso l'esterno di 120 gradi dal suo centro. Un movimento fluido e piacevole, in un gioco infinito di equilibrio.

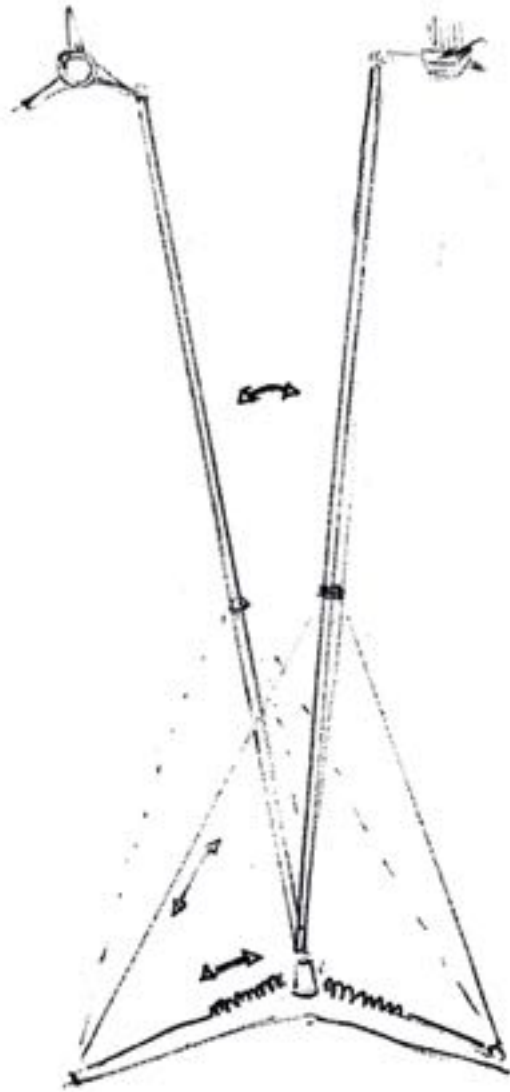

Many radio towers are held in place by thick steel wires, supporting the loads from three different directions, holding the thin tower in place. What happens if you add the freedom of movement to mix? Three spring loaded cords form a comprehensive mechanism, allowing the Y3s pole to move freely and effortlessly in any possible direction. A ballet of stretching and contracting springs, that ease it's motion along the base with an outward movement of 120 degrees away from its center. A fluid, pleasant motion, in an infinite game of balance.

SIMON SCHMITZ



Simon Schmitz





Y3

SIMON SCHMITZ



Lampada da terra dinamica a luce diretta, con riflettore orientabile. Grazie ai tre tiranti fissati sull'asta collegati alle tre molle presenti sulla base triangolare, la lampada si orienta, rimanendo sempre bilanciata, in ogni direzione. Struttura in metallo e alluminio verniciata nel colore nero con particolari nel colore arancio. Sorgente di luce a LED, alimentatore elettronico dimmerabile a spina.

Dynamic floor lamp providing direct light, with adjustable reflector. The lamp can be oriented in any direction – remaining always balanced – through three guy-wires fixed on the rod, connected to the three springs present on the triangular base. Structure in metal and aluminum painted black, with details in orange. LED light source, electronic dimmable driver on the plug.

13W LED 1950lm 3000K

2302/NE ● nero / black

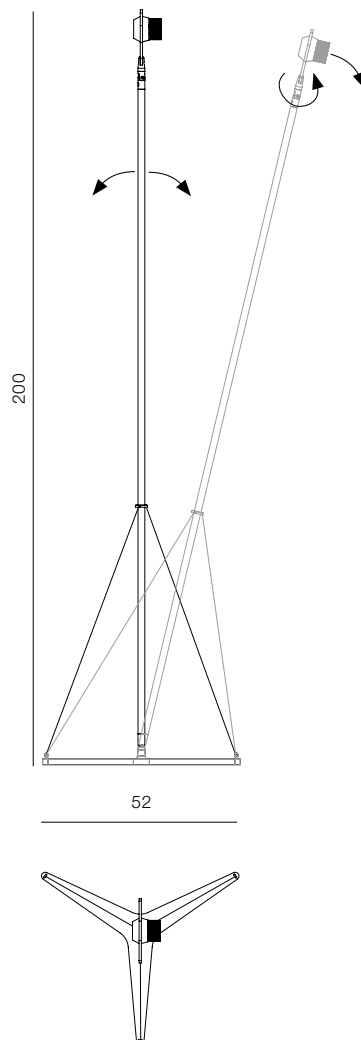



L'AMICA

EMILIANA MARTINELLI



122

Una versione da terra della lampada da tavolo l'Amica, a luce diretta orientabile con sorgente di luce a LED. Un braccio articolato con testa girevole permette di illuminare la tua lettura. Particolari in resina verniciati nel colore living coral, snodi stampati nel colore nero. Base, asta e riflettore in metallo verniciato nel colore nero. Alimentatore elettronico dimmerabile a spina.

Floor version of the L'Amica direct light, adjustable table lamp with LED light source. A folding arm with a swivel head illuminates your reading corner exactly as you please. Details in resin painted in the Living Coral color, cast swivel joints in black. Base, stem and reflector in black-painted metal. Electronic dimmable driver on the plug.

9W LED 900lm 3000K

2303/NE ● nero / black

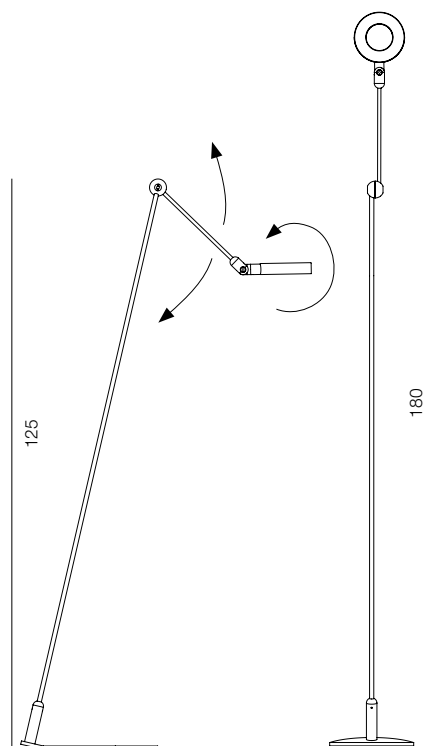





CLOCHARD

Ho sempre dimenticato in giro l'ombrello. Perché è leggero, maneggevole, posso portarlo dove voglio, posso appoggiarlo ovunque. E lo dimentico.

Ho voluto lo stesso spirito nomade nella lampada Clochard.

Le lampade hanno quasi sempre bisogno di una progettazione precisa per il loro posizionamento, alcune sono fissate a parete, altre al soffitto, altre ancora sono ingombranti e pesanti, difficili da spostare. Al contrario Clochard è una lampada senza fissa dimora, senza radici, senza vincoli, la appoggi dove vuoi, dove ti serve. E se la tua vita cambia strada, lei la cambia con te.

Ma Clochard non è soltanto uno spirito libero, è anche uno spirito mutante. Infatti è una lampada, ma è anche un vuotatasche, un comodino, un piccolo tavolino.

I've always left my umbrella lying around. Because it's light, it's handy, I can take it wherever I want, I can put it down anywhere.

And forget about it everywhere.

I wanted the same nomadic spirit in the Clochard lamp.

Lamps almost always need a precise design for their positioning, some are fixed to the wall, others to the ceiling, others are bulky and heavy, difficult to move. On the contrary, Clochard is a lamp with no fixed abode, no roots, no constraints, you can place it wherever you want, wherever you need it.

And if your life changes course, it changes with you.

But Clochard is not only a free spirit, it is also a mutant spirit. In fact, it is a lamp, but it is also a tray, a bedside table, a small table.

ORLANDINI DESIGN

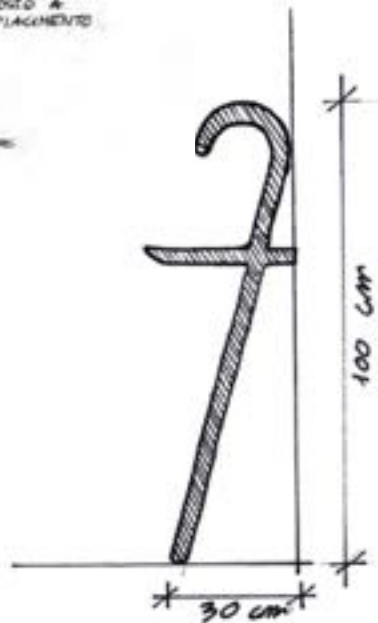
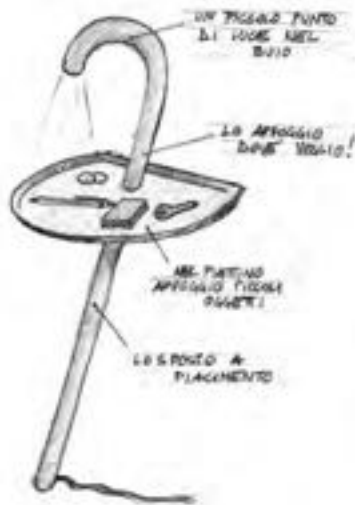

CLOCHARD

ORLANDINI DESIGN



Lampada da terra a luce diretta, tavolino vuota tasche, un oggetto nomade, semplicemente appoggiato al muro.
Struttura in metallo verniciato nel colore bianco o nero, con piano in resina nel colore bianco o nero. Sorgente di luce a LED.
Alimentatore elettronico a spina.

Floor lamp direct light, little table empty pockets, a nomad object simply leaned to the wall. White or black painted metal structure. Resin plane in white or black color. LED light source.
Electronic driver on the plug.

3W LED 300lm 3000K

2289/BI ○ bianco / white

2289/NE ● nero / black

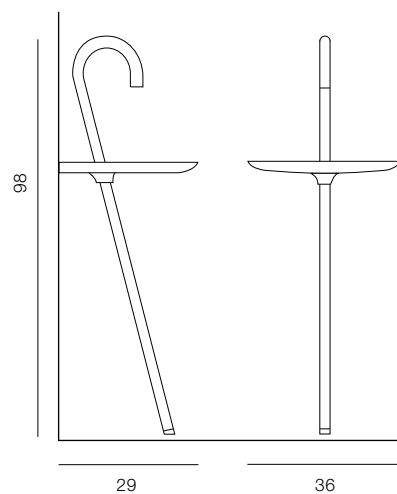





COLIBRÌ

Ho voluto realizzare una lampada esile, un segno grafico, un sottile tubulare che accoglie dei piccoli spot orientabili indipendentemente, così da poter illuminare con un minimo impatto visivo più soggetti anche se posizionati in direzioni diverse.

Poi, per soddisfare altre esigenze di illuminazione, sono state sviluppate altre versioni: Colibrì con asola, le altre versioni da tavolo, a sospensione e da parete. Visibili anche nel catalogo Architectural.

I thought of a slender lamp, a graphic sign, a thin tubular tube that holds small spots that can be oriented independently, so that several subjects can be illuminated with a minimum visual impact, even if they are positioned in different directions. Then, to meet other lighting requirements, other versions were developed: Colibrì with slot, the other table, pendant and wall versions. Also displayed in the Architectural catalogue.

EMILIANA MARTINELLI

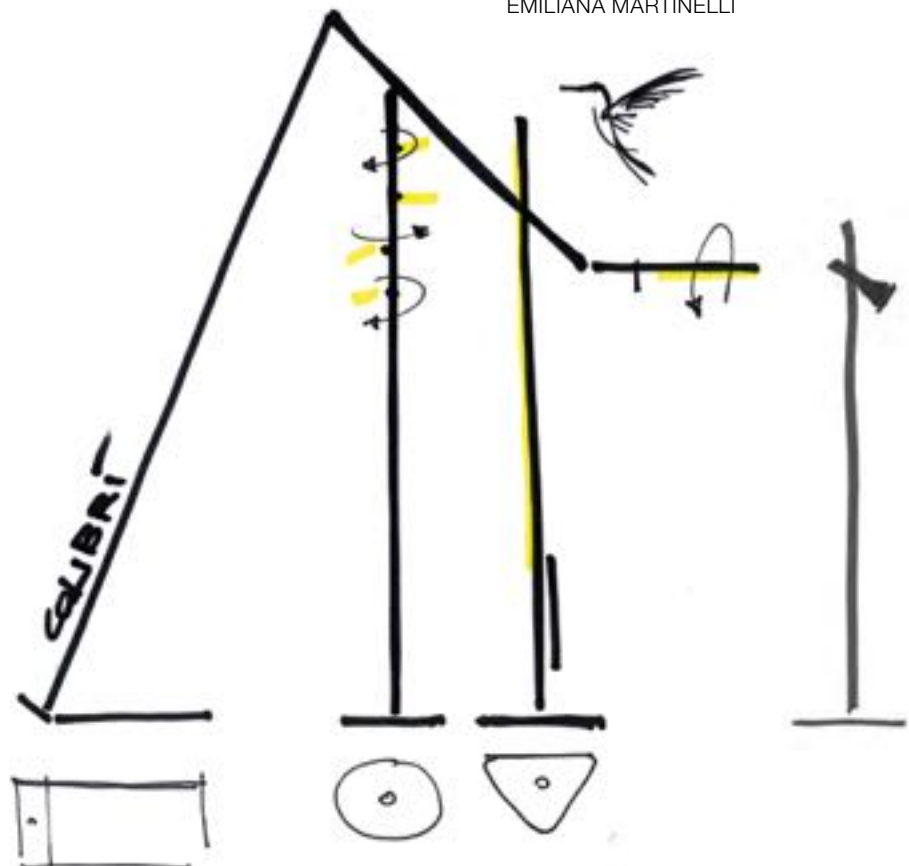

COLIBRÌ

EMILIANA MARTINELLI

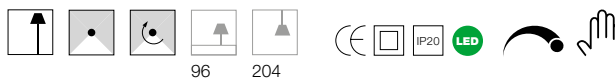

Un semplice faretto conico fissato sull'asta verticale tramite un giunto che permette la rotazione e l'orientabilità, per dirigere la luce verso il basso per una buona lettura o per illuminare verso l'alto il soffitto o un particolare di un quadro.

Lampada da terra a luce diretta orientabile. Struttura tubolare in alluminio verniciato nel colore nero, bianco o giallo, con una testa girevole.

Sorgente di luce a LED con fascio luminoso medium, narrow e wide.

Tasto touch per la dimmerazione sull'asta.

Alimentatore elettronico a spina.

A simple conical spotlight fixed on the vertical rod by means of a joint that allows rotation and swivelling, to direct the light downwards for good reading or to illuminate upwards the ceiling or a detail of a painting. Adjustable direct light floor lamp.

LED light source.

Tubular aluminium structure painted in black, white or yellow color, with an swivelling head.

LED light source with medium, narrow or wide light beam.

Touch button for dimming on pole.

Electronic driver on the plug.

6W LED medium 600lm 2700K

2312/NE ● nero / black

2312/BI ○ bianco / white

2312/GI ● giallo / yellow

su richiesta fascio narrow o wide
narrow or wide beam on request

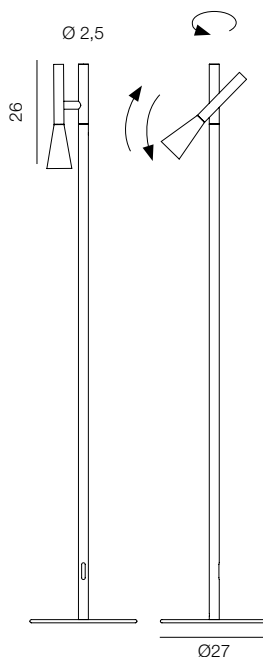

330



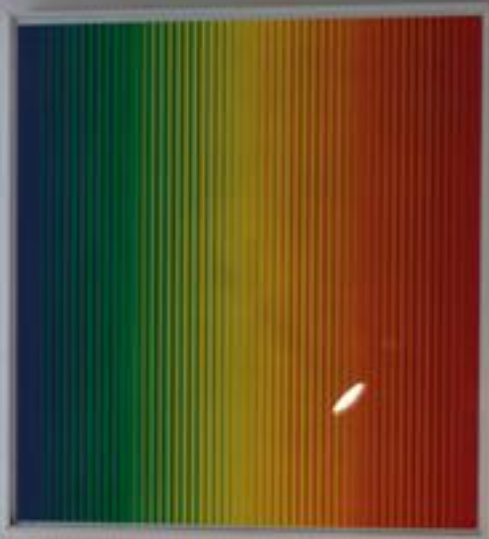

COLIBRÌ

EMILIANA MARTINELLI



Lampada da terra a luce diretta orientabile.
Struttura tubolare in alluminio verniciato
nel colore nero, con quattro teste snodate,
girevoli e indipendenti, così da illuminare
soggetti da diverse angolazioni. Sorgente di
luce a LED con fascio luminoso medium.
Alimentatore elettronico a spina.
Disponibile anche in altre versioni, vedi
catalogo architectural.

Floor lamp for direct light adjustable.LED
light source.
Tubular structure in black painted aluminium
with four jointed heads swelling and
independent, to light object at different
angles. LED light source with medium light
beams. Electronic driver on the plug. Also
available in other versions, see architectural
catalogue.

4x3W LED medium 4x300lm 3000K

2278/NE ● nero / black

su richiesta fascio di luce narrow o wide
narrow or wide light beam on request



332

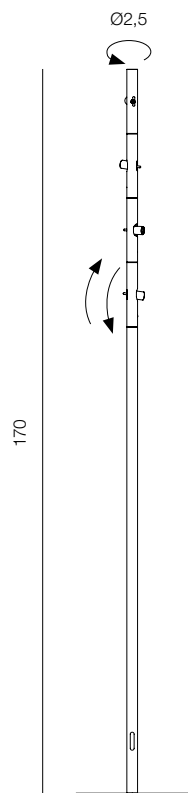



COLIBRÌ

EMILIANA MARTINELLI

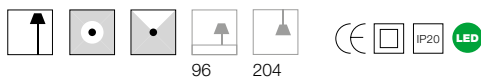

Lampada da terra a luce indiretta. Struttura in tubolare di alluminio anodizzato oro o verniciato nel colore nero. Diffusore in policarbonato. Sorgente di luce a LED. Alimentatore elettronico integrato nel corpo cilindrico fissato sulla struttura della lampada.

Floor lamp indirect light. Tubular structure in anodised gold or black painted aluminium. Polycarbonate diffuser. LED light source. Electronic driver integrated in the cylindrical body fixed on the structure of the lamp.

14W LED 2300lm 3000K

2290/NE ● nero / black

2290/AU ● anodizzato oro / anodised gold

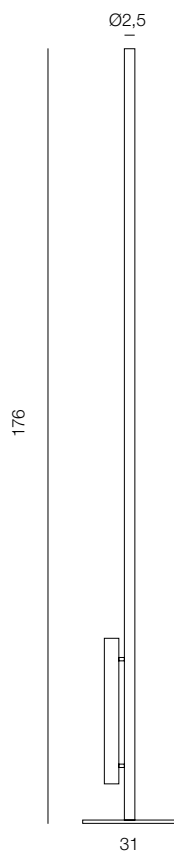





BOWL

Una sfera a luce diffusa in polietilene, da interno e outdoor, da appoggiare sul pavimento o sul tavolo in casa, in terrazza o in giardino. La maniglia permette di prenderla e spostarla facilmente nel punto da illuminare.

A polyethylene diffused light sphere, for interior and outdoor, to be placed at home on the floor or on the table, on the terrace and in the garden.

The handle allows to easily lift it and move it to the right place you want to illuminate.

SERGE & ROBERT CORNELISSEN

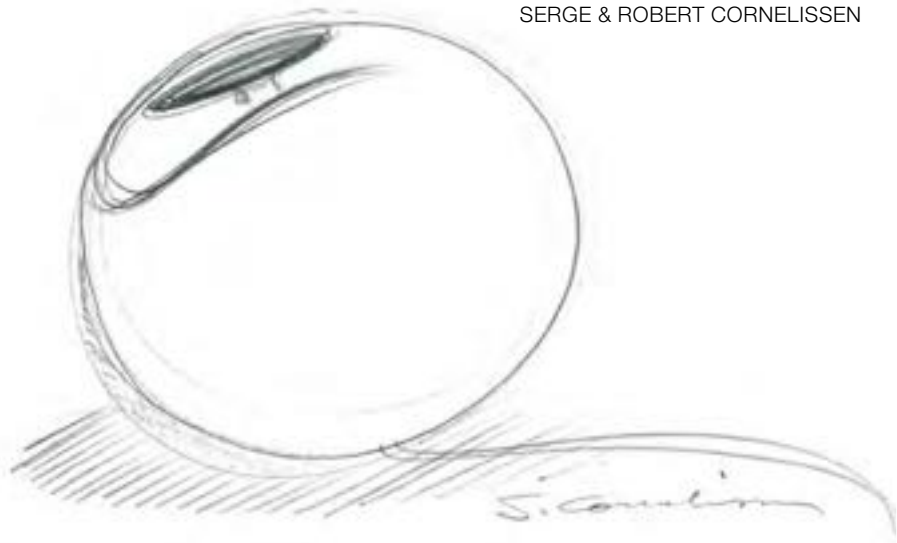

BOWL

SERGE & ROBERT CORNELISSEN



Lampada da appoggio per interno o per esterno a luce diffusa. Stampata in rotazionale, materiale in polietilene bianco, particolare maniglia di colore nero stampata in resina.

Con cavo (3 m) e spina.

Per lampadina a LED.

Indoor or outdoor floor lamp with diffused light.

Printed with rotational molding technology, white polyethylene material, black handle in moulded resin.

With cable (3 m) and plug.

For LED bulb.

15W E27 LED

812 ○ bianco / white



Ø35



Abitazione privata, Lucca, arch. Chiantelli



... becoming ...

PIN basculante

Quando ero piccolo, mi piaceva giocare con spilli e cartoncini a testa tonda per realizzare modelli e piccoli oggetti. Trovavo gli spilli affascinanti, permettevano di creare e modificare forme o spazi così facilmente. Questo è esattamente lo scopo della lampada PIN, è versatile, può essere usata a testa in giù, o in su, può essere più grande o piccola, a seconda del suo utilizzo ma rimane sempre divertente.

When I was little, I liked to play with round-headed pins and pieces of cardboard to create models and small objects. I found pins fascinating; they allowed me to create and modify shapes or spaces so easily. This is exactly the scope of my PIN lamp: it is versatile, it can be used upside down, it can be big or small, based on its use. But it is always fun.

MICHEL BOUCQUILLON

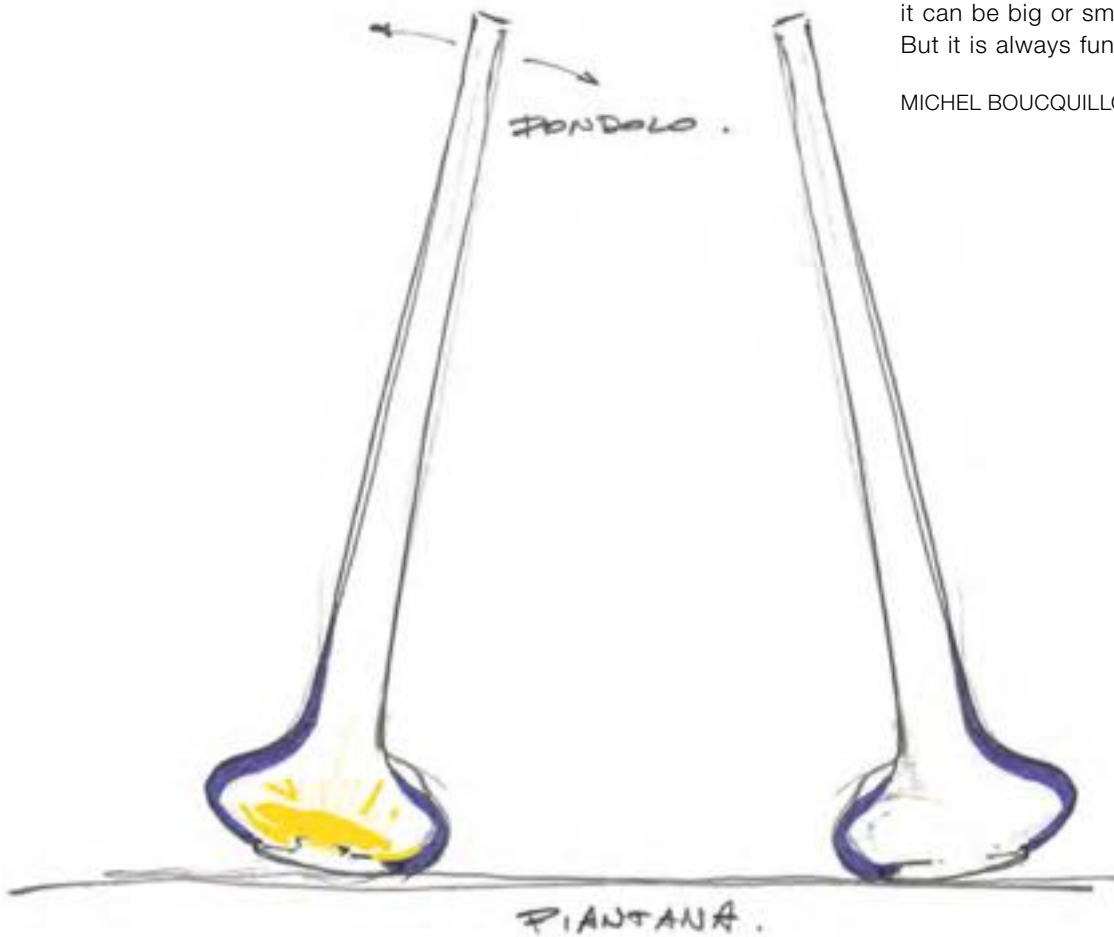

PIN basculante

MICHEL BOUCQUILLON



Lampada da terra, a luce diffusa, in equilibrio dinamico. Base in metallo satinato. Struttura stampata in rotazionale, materiale polietilene bianco. Supporto di chiusura in silicone. Per sorgente di luce a LED, alimentatore elettronico dimmerabile. Anche nella versione da soffitto e parete.

Floor lamp diffused light, dynamic equilibrium. Base in brushed metal rotational moulded structure in white polyethylene material. Sylicon support. LED light source, electronic dimmable driver. Also available in the wall and ceiling version.

28W LED 2000lm 3000K

2287/DIM/L/1/BI ○ bianco / white

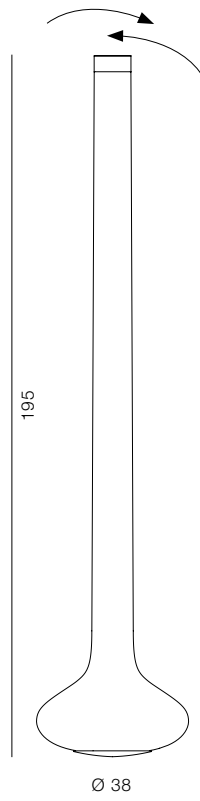



Casa Farnetina, arch. Michel Boucquillon e Donia Maaoui, Lucca



EVA

Un paralume in stoffa fissato su un treppiedi in alluminio naturale, verniciato o in legno. Una lampada da terra in due dimensioni che si fa notare ma non prende il tuo posto. Il filo rosso ne evidenzia il carattere e con Eva extralarge si amplia una famiglia che comprende lampade da tavolo e da terra.

A lamp shade made of fabric fixed on a tripod in natural painted aluminium or in wood. A floor lamp in two sizes that stands out but does not take your place. The red thread underlines its character and with Eva extralarge si amplia una famiglia che comprende lampade da tavolo e da terra.

EMILIANA MARTINELLI







EVA

EMILIANA MARTINELLI



Lampada da terra a luce indiretta o diffusa.
Struttura in alluminio anodizzato naturale con paralume in tessuto, nel colore bianco o nero con interno bianco. Struttura verniciata nel colore nero, con paralume nero e interno bianco. Struttura in legno con paralume bianco, nero o beige.
Per lampadina dimmerabile a LED e variatore di luce sul cavo.

Floor lamp indirect or diffused light.
Natural anodized aluminium structure, with fabric shade in white or black colour inside in white color. Black painted structure with black fabric shade, inside in white color. Wooden structure with white, black or beige fabric shade. With dimmable LED bulb and light intensity regulator on the cable.

EVA
1x15W E27 LED

- 2270/BI ○ paralume bianco / white shade
- 2270/NE ● paralume nero / black shade
- 2270/NE/NE ● paralume nero-struttura nera
black shade-black structure

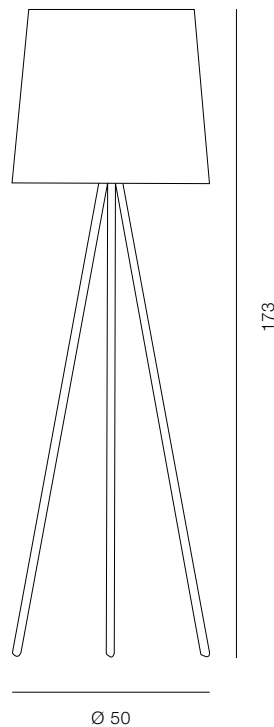



EVA XG

EMILIANA MARTINELLI



Lampada da terra a luce indiretta di grandi dimensioni. Struttura in metallo verniciato nel colore nero. Paralume in tessuto nel colore nero con interno bianco. Con variatore di intensità luminosa sul cavo. Per lampadina a LED dimmerabile.

Floor lamp indirect light. Painted metal structure in black colour. Fabric shade in black colour, white colour inside. With light intensity regulator on the cable. For dimmable LED bulb.

1x20W E27 LED

2270/XG/NE/NE ● paralume nero-struttura nera
black shade-black structure

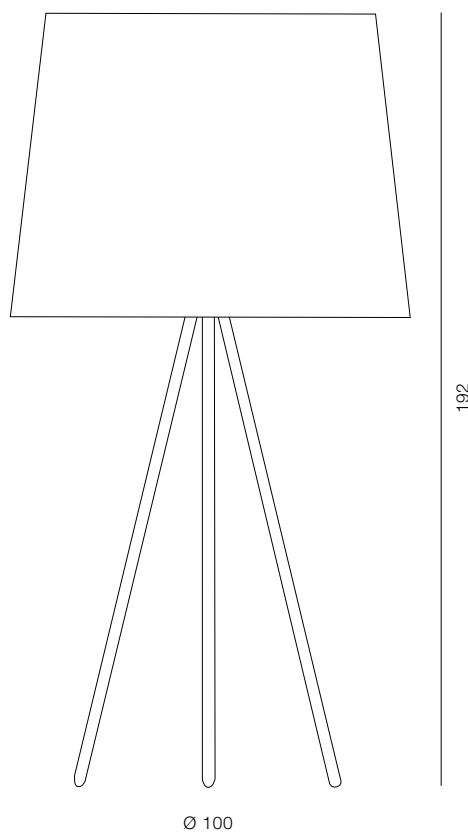





PISTILLO E PISTILLONE

Un cilindro in metacrilato o in alluminio diffonde o proietta la luce verso l'alto per illuminare un atrio, una sala, una volta, un soffitto affrescato, un particolare architettonico, uno spazio qualunque, per creare diversi effetti di luce.

A methacrylate or aluminium cylinder diffuses or projects light upwards to illuminate an atrium, a hall, a vault, a frescoed ceiling, an architectural detail, any space, to create different lighting effects.

EMILIANA MARTINELLI

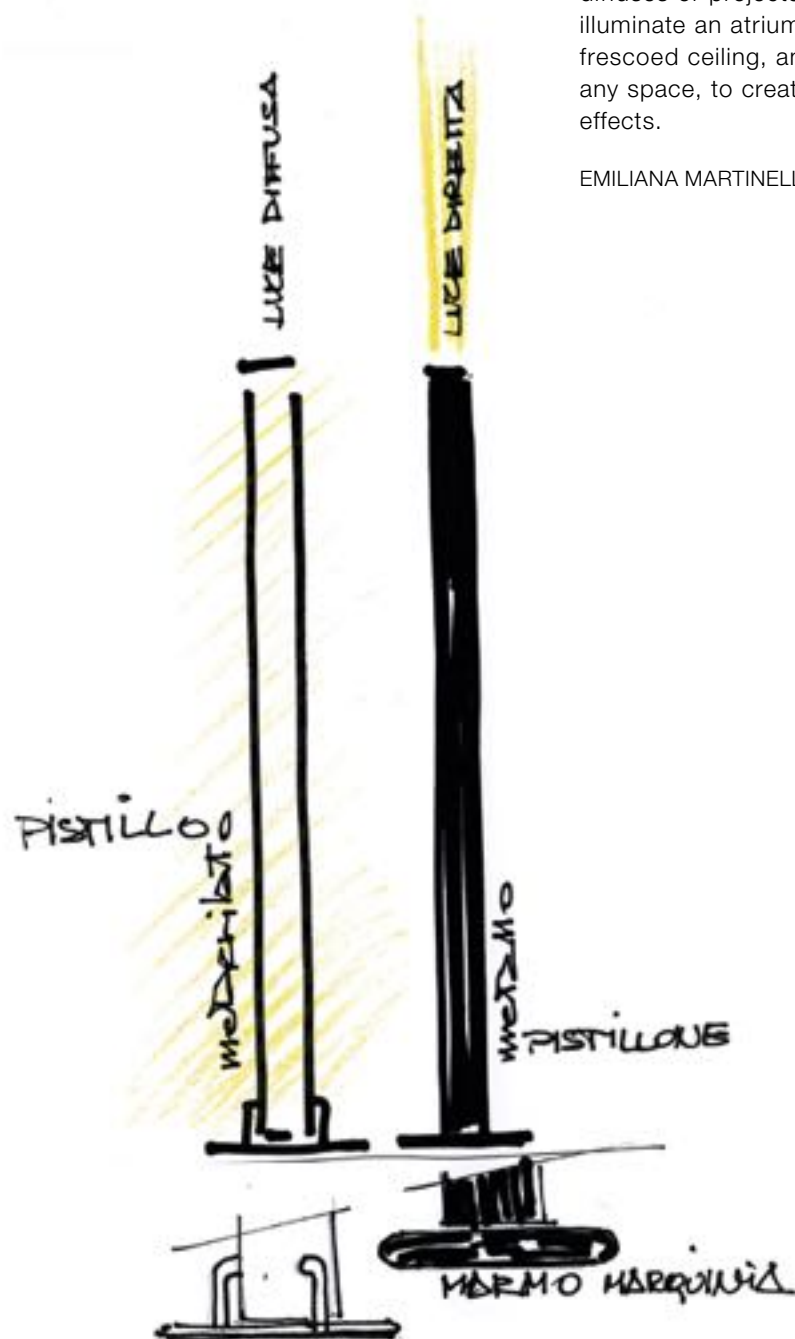

PISTILLONE

EMILIANA MARTINELLI



Lampada da terra a luce indiretta.
Struttura in metallo verniciato nel colore
nero lucido. Base in marmo nero Marquinia
per impreziosire questa semplice lampada.
Sorgente di luce a LED.
Dimmerabile con variatore di luce sul cavo.

Floor lamp with indirect light.
Metal structure painted in glossy black color.
Black Marquinia marble base to enhance this
simple lamp.
LED light source.
Dimmable with dimmer switch on the cable.

31W LED 4090lm 3000K

2304/NE/MAR/MR ● nero / black

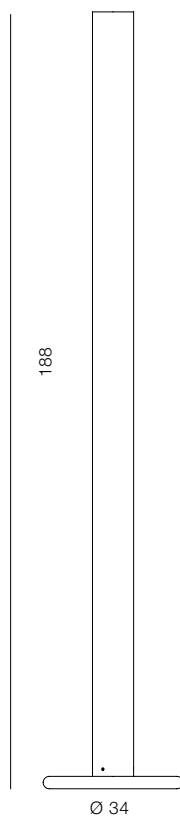





PISTILLO

EMILIANA MARTINELLI

Lampada da terra a luce diffusa.
Tubo in metacrilato opal bianco,
base e particolari in metallo verniciato.
Sorgente di luce a LED.
Dimmerabile con variatore di luce sul cavo.

Floor lamp diffused light. White opal
methacrylate tube, and painted metal base
and supports. LED light source.
Dimmable with dimmer switch on the cable.

60W LED 4700lm 3000K

2260/P/L/1/BI ○ bianco / white

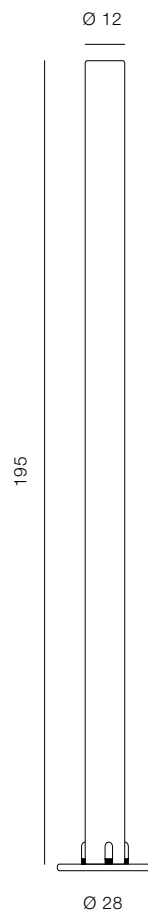







BICONICA POL

Un segno semplice definisce un doppio volume che sorprende per la sua forte identità. Un unico elemento in polietilene stampato con la tecnologia rotazionale per una luce diffusa. Una fedele compagna per illuminare i tuoi spazi interni o esterni.

An easy distinctive sign can cause a double volume that surprises for its strong identity. A single element made in polyethylene moulded rotational for a diffused light. A faithful companion to light your space indoor or outdoor.

EMILIANA MARTINELLI

BICONICA

Ambly Co.



Negozio Olivetti, Venezia.
Bene in concessione al
FAI – Fondo per l'Ambiente Italiano.
In corso durante lo shooting:
"Together. L'abitare contemporaneo di ieri,
oggi e domani", mostra curata da Daniele
Lauria e organizzata in collaborazione dal
FAI, dall'Ordine degli Architetti di Venezia e
dalla rivista IQD.
15 settembre – 21 novembre 2021

Olivetti shop, Venice.
Property in concession to
FAI – Fondo per l'Ambiente Italiano.
During the shooting there was an
event going on: "Together. L'abitare
contemporaneo di ieri, oggi e domani"
(Together. Contemporary living yesterday,
today and tomorrow), an exhibition
curated by Daniele Lauria and organised
in collaboration with FAI, the Ordine degli
Architetti di Venezia and IQD magazine.
15 September – 21 November 2021







BICONICA POL

EMILIANA MARTINELLI



LIGHT YOU LIKE

Lampada da terra per interno ed esterno IP65 a luce diffusa. Struttura in polietilene stampata in rotazionale.

Lampada dimmerabile Bluetooth con APP Casambi nelle versioni con sorgente di luce a LED tunable white e RGB (vedi pag. 30-31). Disponibile anche nella versione con sorgente di luce a LED tunable white con telecomando. Alimentatore elettronico dimmerabile incluso.

Floor lamp for indoor and outdoor use IP65 with diffused light. Structure in rotomoulded polyethylene.

Bluetooth dimmable lamp with Casambi APP in the versions with tunable white and RGB LED light source (see pages 30-31). Also available in the version with tunable white LED light source with remote control. Electronic dimmable ballast included.



TUNABLE WHITE
con telecomando / with remote control
104W LED 5320lm 2500-6700K

2217/POL/P/BD/L/1 bianco / white



TUNABLE WHITE
bluetooth CASAMBI
104W LED 5320lm 2500-6700K



2217/POL/P/BD/BT/L/1 bianco / white



RGB-W
bluetooth CASAMBI
104W LED RGB



2217/POL/P/BT/L bianco / white



195

Ø 38



Lucca Biennale Cartasia 2022, Villa Bottini, Lucca



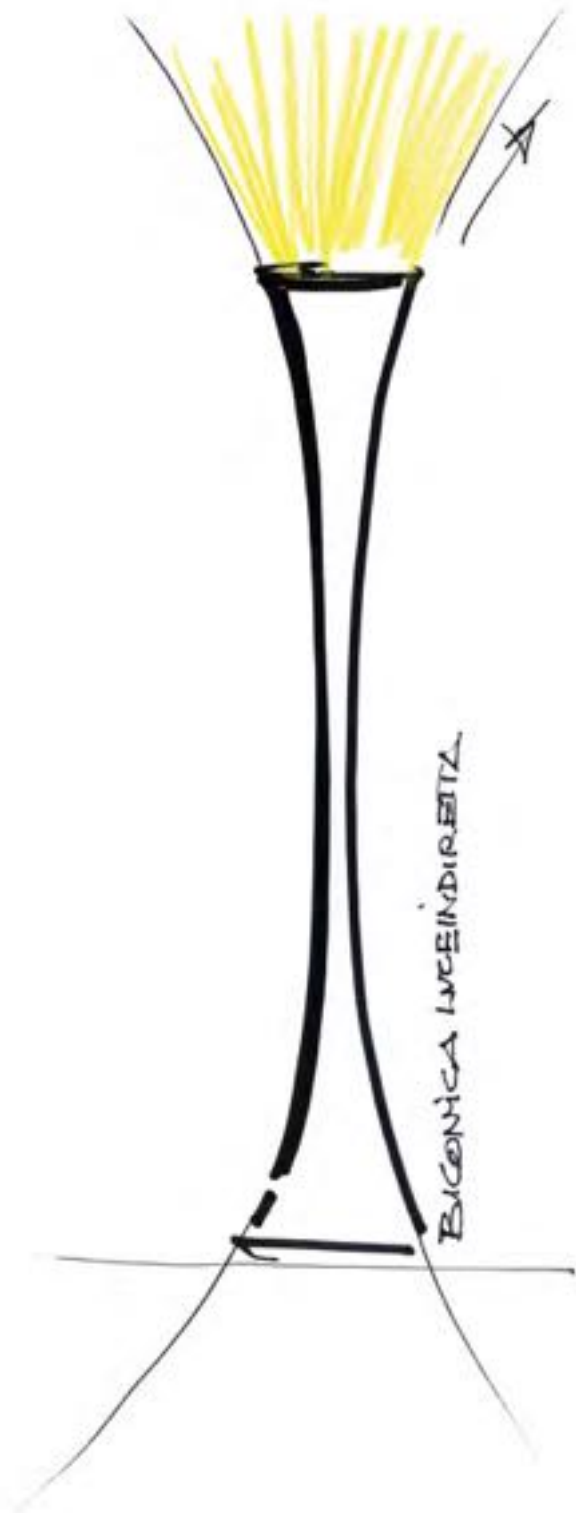

BICONICA

Lo stesso segno per Biconica a luce indiretta per luce a LED dimmerabile, per illuminare ambienti interni. Stampata in resina e verniciata in vari colori.

The same sign for Biconica with indirect light for dimmable LED light, to illuminate indoor environments. Printed in resin and painted in various colors.

ELIO MARTINELLI

BICONICA

ELIO MARTINELLI



Lampada da terra a luce indiretta. Corpo stampato in resina verniciato nei colori bianco, nero o dorato. Con regolatore d'intensità luminosa sul cavo. Per sorgente di luce LED. Completa di alimentatore elettronico dimmerabile.

Floor lamp indirect light. White, black or golden moulded resin painted structure. With light intensity regulator on the cable. For LED light source. Complete of electronic dimmable driver.

28W LED 3700lm 3000K

2217/L/1/BI ○ bianco / white

2217/L/1/NE ● nero / black

2217/L/1/AU ● dorato / golden

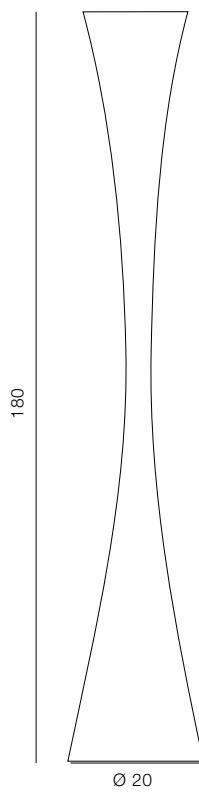





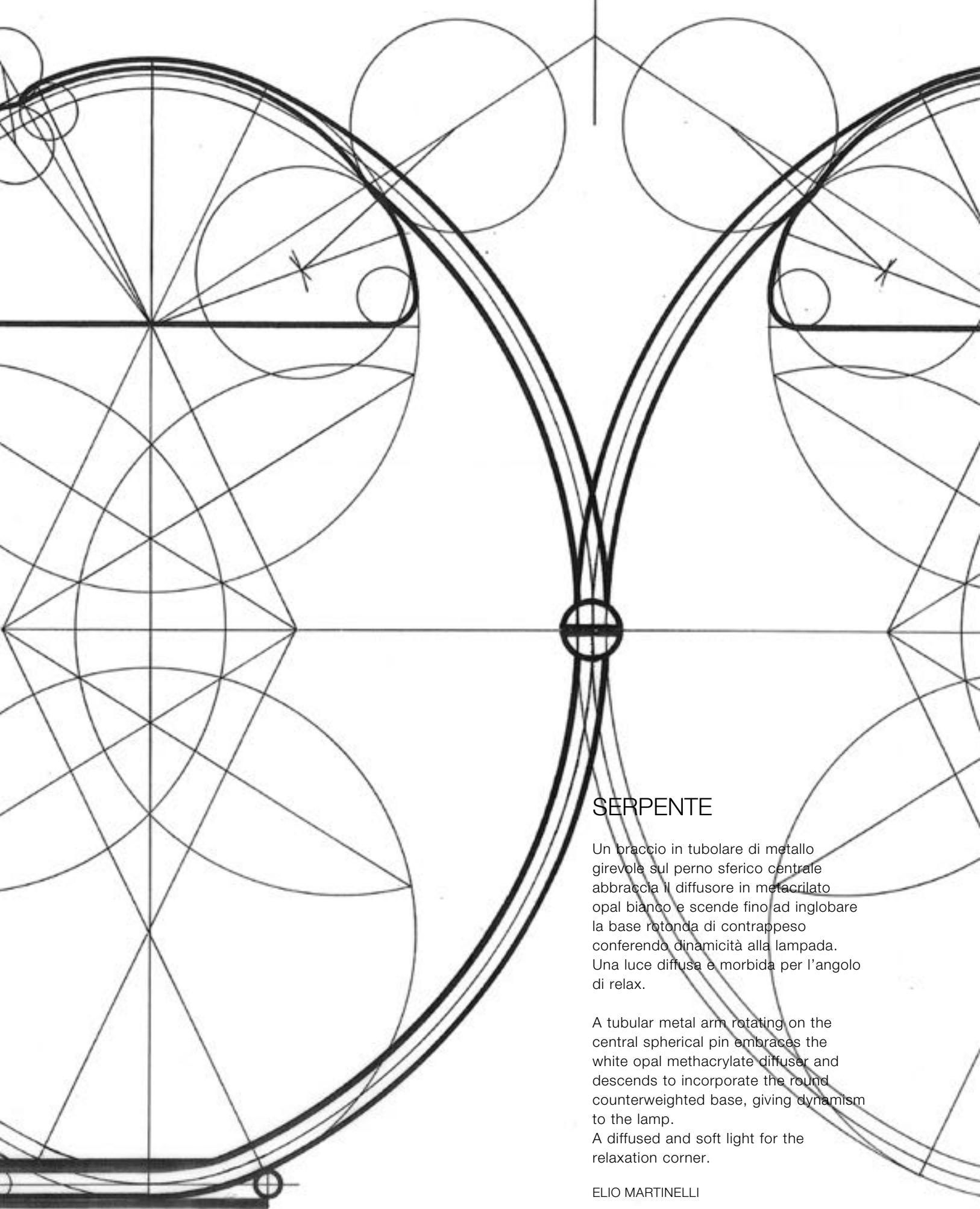

SERPENTE

Un braccio in tubolare di metallo girevole sul perno sferico centrale abbraccia il diffusore in metacrilato opal bianco e scende fino ad inglobare la base rotonda di contrappeso conferendo dinamicità alla lampada. Una luce diffusa e morbida per l'angolo di relax.

A tubular metal arm rotating on the central spherical pin embraces the white opal methacrylate diffuser and descends to incorporate the round counterweighted base, giving dynamism to the lamp.

A diffused and soft light for the relaxation corner.

ELIO MARTINELLI





SERPENTE

ELIO MARTINELLI

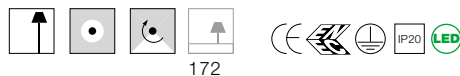

Lampada da terra a luce diffusa.
Braccio girevole con snodo sferico nella
parte centrale per la rotazione e base in
metallo verniciati nel colore bianco e dorato.
Diffusore in metacrilato opal bianco.
Disponibile anche nella versione da tavolo.
Per lampadina a LED

Floor lamp diffused light.
Swivelling upper arm with spheric joint
in the central part for rotation.
Metal painted structure in white and golden
colour. White opal methacrylate diffuser.
Available also in the table version.
For LED bulb.

1x15W E27 LED

2131/BI ○ bianco / white

2131/AU ● dorato / golden

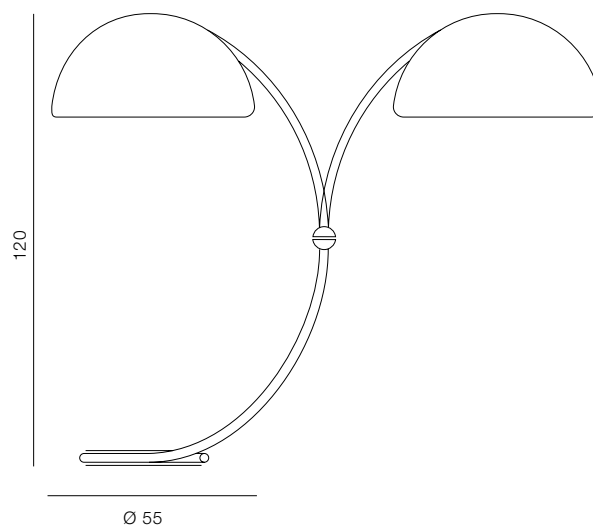

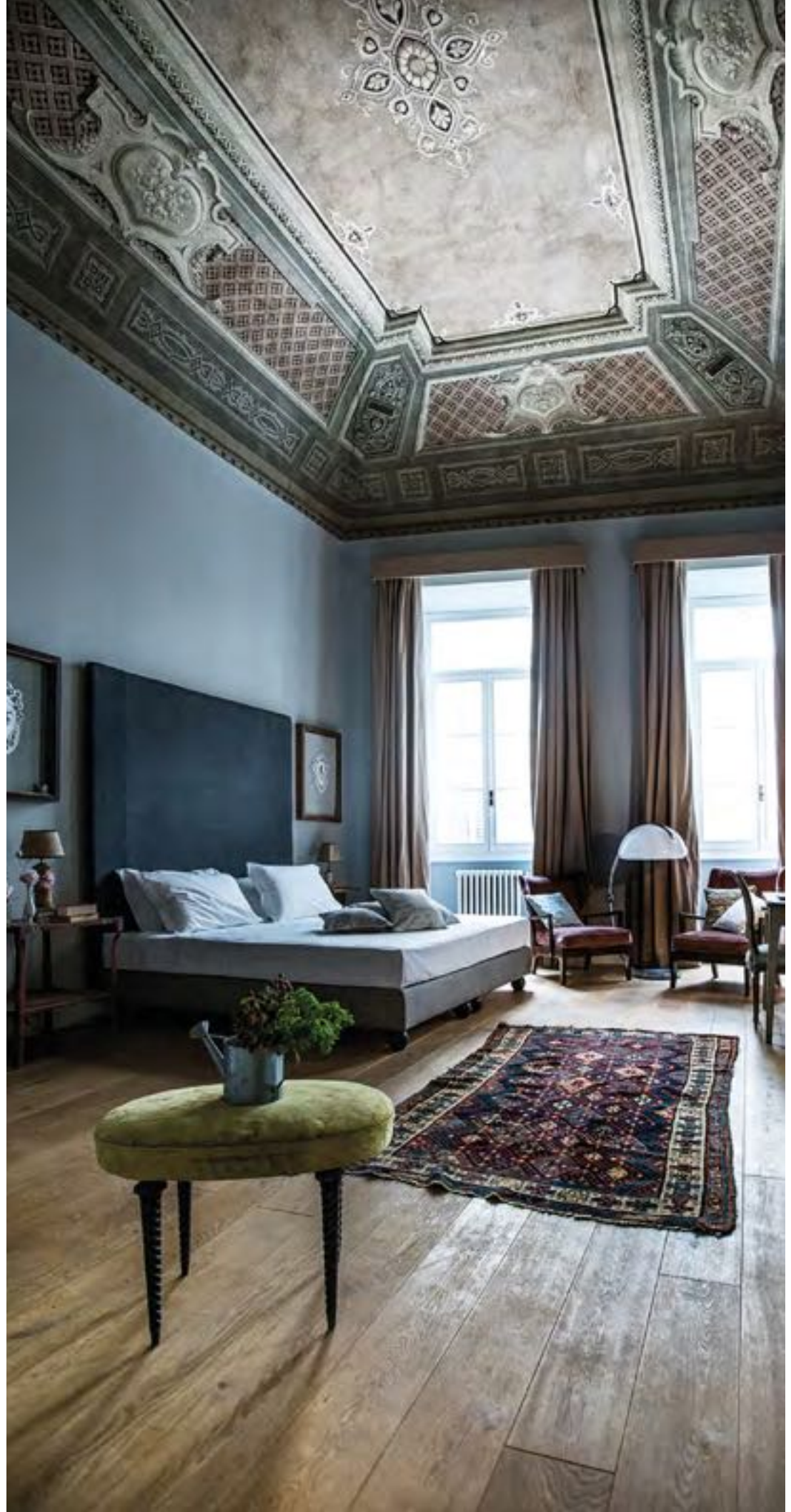



LAMPADE DA PARETE
E SOFFITTO
WALL AND CEILING LAMPS



METRICA

Metrica a parete può essere utilizzata come testa-letto per illuminare con una luce diffusa e morbida le proprie letture o semplicemente il relax notturno. È caratterizzata da un corpo in alluminio della lunghezza di 15 cm che sembra uscire dal muro in maniera elegante ed essenziale. La sorgente di luce a LED presenta un'estensione della lunghezza di 9,5 cm nascosta all'interno del supporto che forma la base, si accende nel momento in cui viene estratta, aumentando progressivamente di intensità fino a raggiungere la posizione massima. La base circolare ruota su se stessa a 360°, direzionando la luce secondo le necessità personali.

Metrica wall light can be used as a bed-head light to illuminate one's reading or simply relaxing at night with a diffuse and soft light. It is characterised by a aluminium body with a length of 15 cm that seems to emerge from the wall in an elegant and essential manner. The LED light source has a 9.5 cm long extension hidden inside the support that forms the base, it lights up the moment it is pulled out, gradually increasing in light intensity until it reaches its maximum position. The circular base rotates 360°, directing the light according to personal needs.

STUDIO HABITS

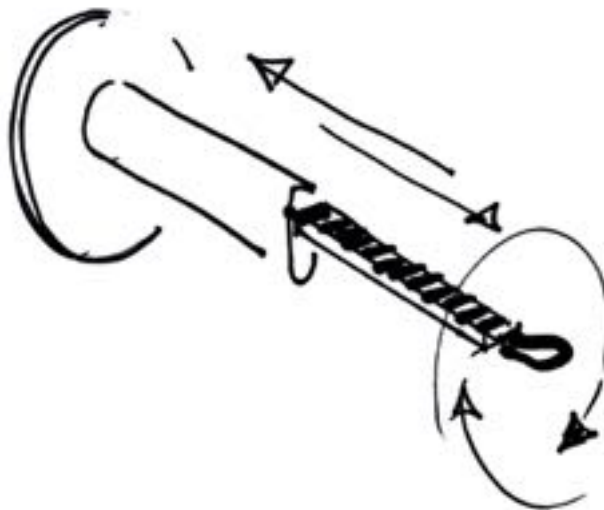
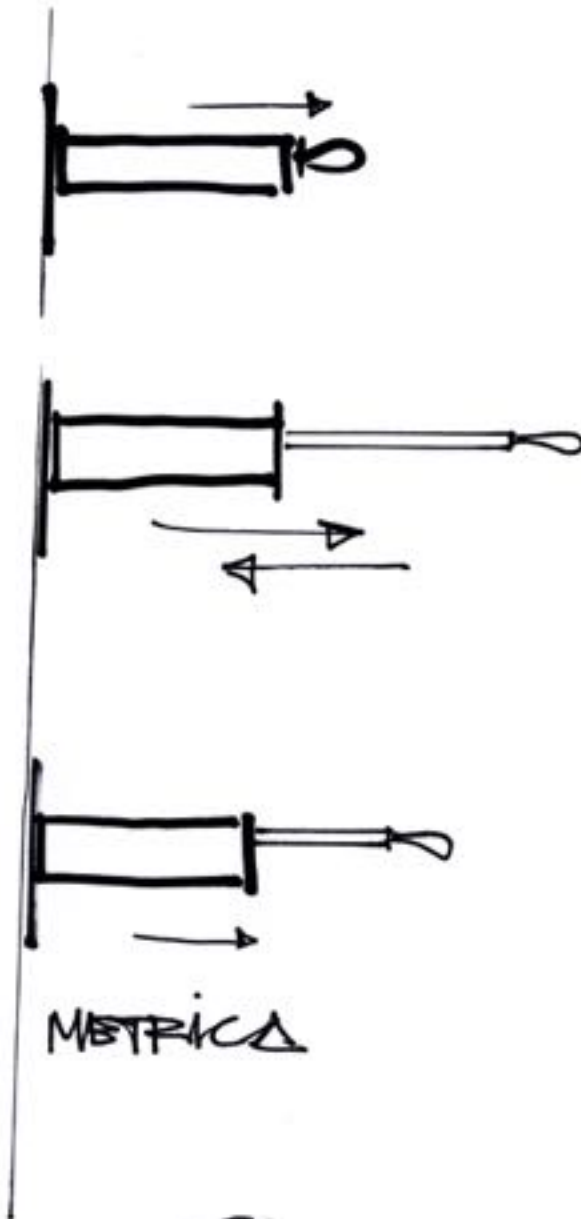

METRICA parete

STUDIO HABITS

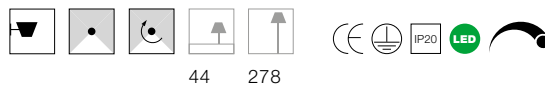

44 278

Lampada da parete a luce diretta orientabile che si accende e si spegne quando la sorgente di luce a LED viene estratta o riposizionata all'interno del corpo lampada. La base circolare ruota su se stessa a 360°, direzionando la luce secondo le necessità personali. Struttura in alluminio estruso verniciato nel colore bianco, base nel colore bianco.

Direct light wall lamp that switches on and off when the LED light source is removed or repositioned inside the lamp body. The circular base rotates 360°, directing the light according to personal needs. Extruded aluminium frame painted in white, base in white.

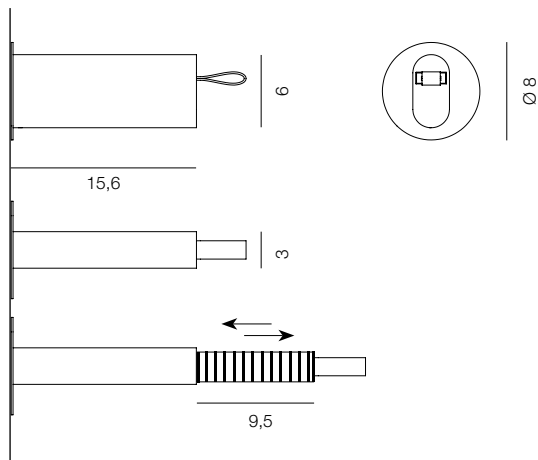

4W LED 170lm 3000K

1459/BI ○ bianco / white







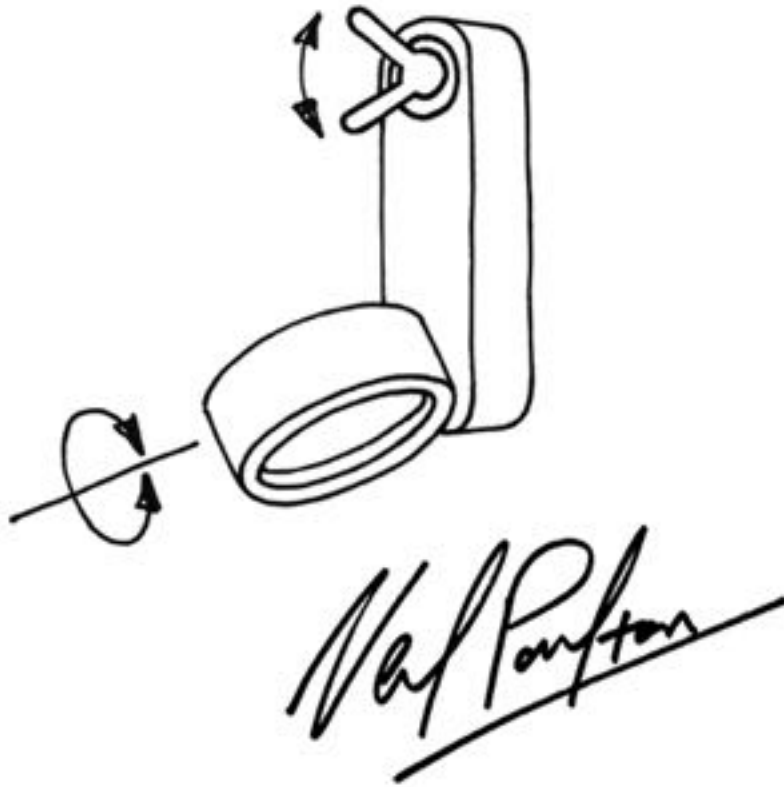

TOGGLE

Quando ero piccolo volevo essere un "Guitar Hero". Avevo una copia di una chitarra Les Paul che suonavo per ore ogni giorno. Aveva un grande interruttore "Toggle", che mi piaceva azionare – anche se in realtà non succedeva nulla – perché la mia chitarra elettrica non era elettrificata. Infatti, il mio budget non mi aveva permesso di acquistare un amplificatore. Ma il fascino per l'interruttore "Toggle" è rimasto. La lampada "Toggle" è stata progettata per essere una piccola lampada versatile per la lettura notturna, in grado di essere montata in molteplici orientamenti. La caratteristica della lampada – l'interruttore "Toggle" – è stata rubata dall'iconica chitarra Les Paul di Gibson, dotata appunto di questo tipo interruttore che ti consente di passare da un pickup all'altro, ora riproposto come interruttore on-off con dimensioni maggiori e facile da azionare (Perché sì, ora so come funziona). Il risultato è un'amichevole piccola lampada da parete con una coda scodinzolante e una grande testa facilmente orientabile, ideale per la tua testiera del letto o la tua parete.

When I was a kid I wanted to be a guitar hero. I had a copy of a Les Paul guitar which I played for hours every day. It had a big "Toggle" switch, which I loved to flip – although it didn't do anything – because my electric guitar wasn't electrified. My budget didn't extend to an amplifier. But the fascination with the "Toggle" switch remained. The "Toggle" lamp was designed to be a versatile little nighttime reading lamp, able to be mounted in multiple orientations. The lamp's signature detail – the "Toggle" switch – was stolen from Gibson's iconic Les Paul guitar – the switch which lets you toggle between pickups, now redeployed as an oversized, easy to flip on-off switch. (Yes, now I know what it does). The result is a friendly little wall lamp with a wagging "toggle" tail and a big, easily orientated head, ideal for your headboard or wall.

NEIL POULTON





TOGGLE

NEIL POULTON



Lampada da parete a luce diretta orientabile. Struttura in pressofusione di alluminio verniciato nelle finiture opaco goffrato bianco, grigio scuro o antracite, con interruttore nero lucido. Diffusore in policarbonato. Sorgente di luce a LED, alimentatore integrato nel corpo lampada.

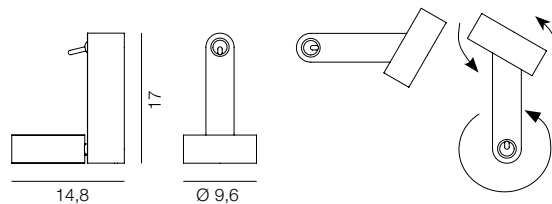

Adjustable wall lamp with direct light. Die-cast aluminium structure painted in embossed matt finishes white, dark grey or anthracite, with glossy black switch. Polycarbonate diffuser. LED light source, electronic driver integrated in the body lamp.

4,5W LED 700lm 2700K

1455/BI bianco / white

1455/GR grigio scuro / dark grey

1455/AN antracite / anthracite



THO
↑



↓
MGO





CABRIOLETTE

Piccola, orientabile, funzionale, rotonda e giocosa.

Una testa orientabile a luce diretta e diffusa per illuminare e creare vari effetti di luce sulla parete.

Disponibile nella versione da tavolo e nella versione cordless.

Small, adjustable, functional, circular and playful.

A swivelling head with direct and diffuse light for illuminating and creating various lighting effects on the wall. Available in the table and in the cordless version.

STUDIO NATURAL

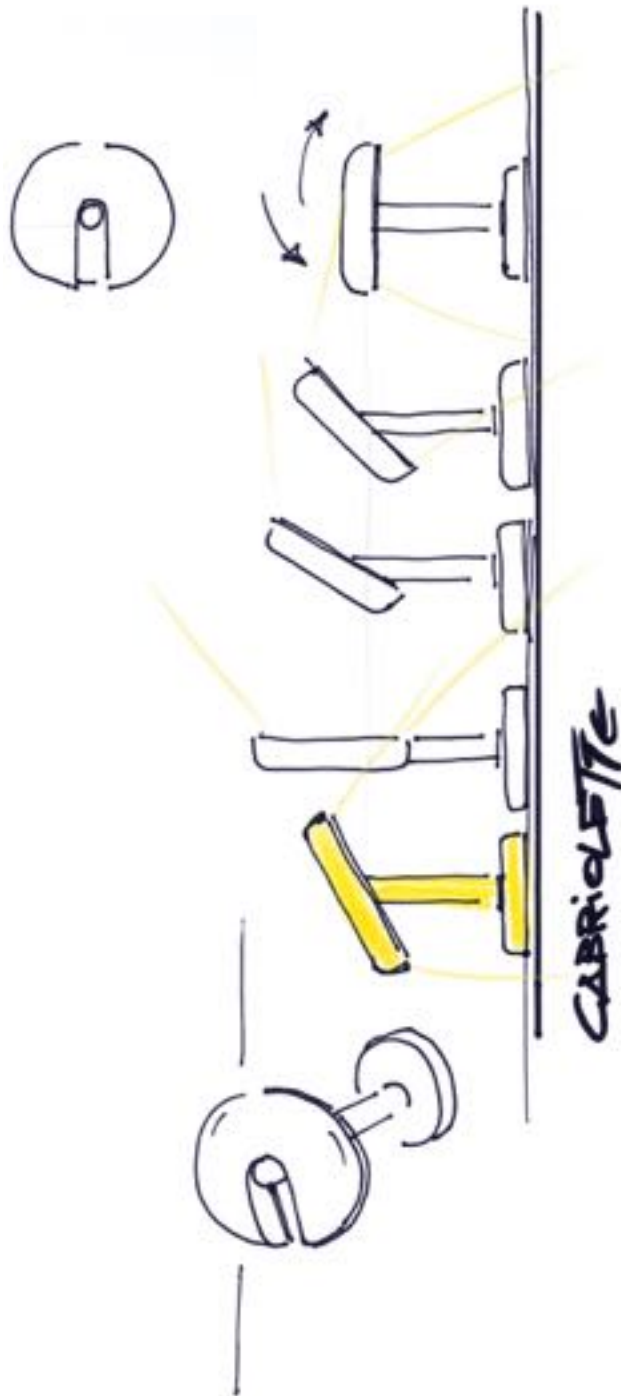

CABRIOLETTE

STUDIO NATURAL



Lampada da parete a luce diretta con riflettore orientabile.
Struttura in pressofusione di alluminio verniciato nei colori bianco e nero.
Diffusore in policarbonato opal bianco.
Sorgente di luce a LED e alimentatore integrati.

Direct light wall lamp with adjustable reflector.
Die-cast aluminium structure painted in white and black.
White opal polycarbonate diffuser.
Integrated LED light source and driver.

14W LED 2200lm 2700K

1442/BI ○ bianco / white

1442/NE ● nero / black

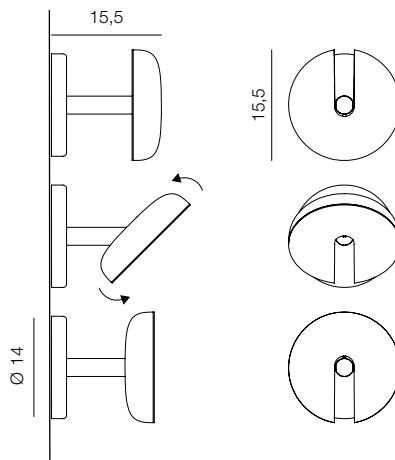





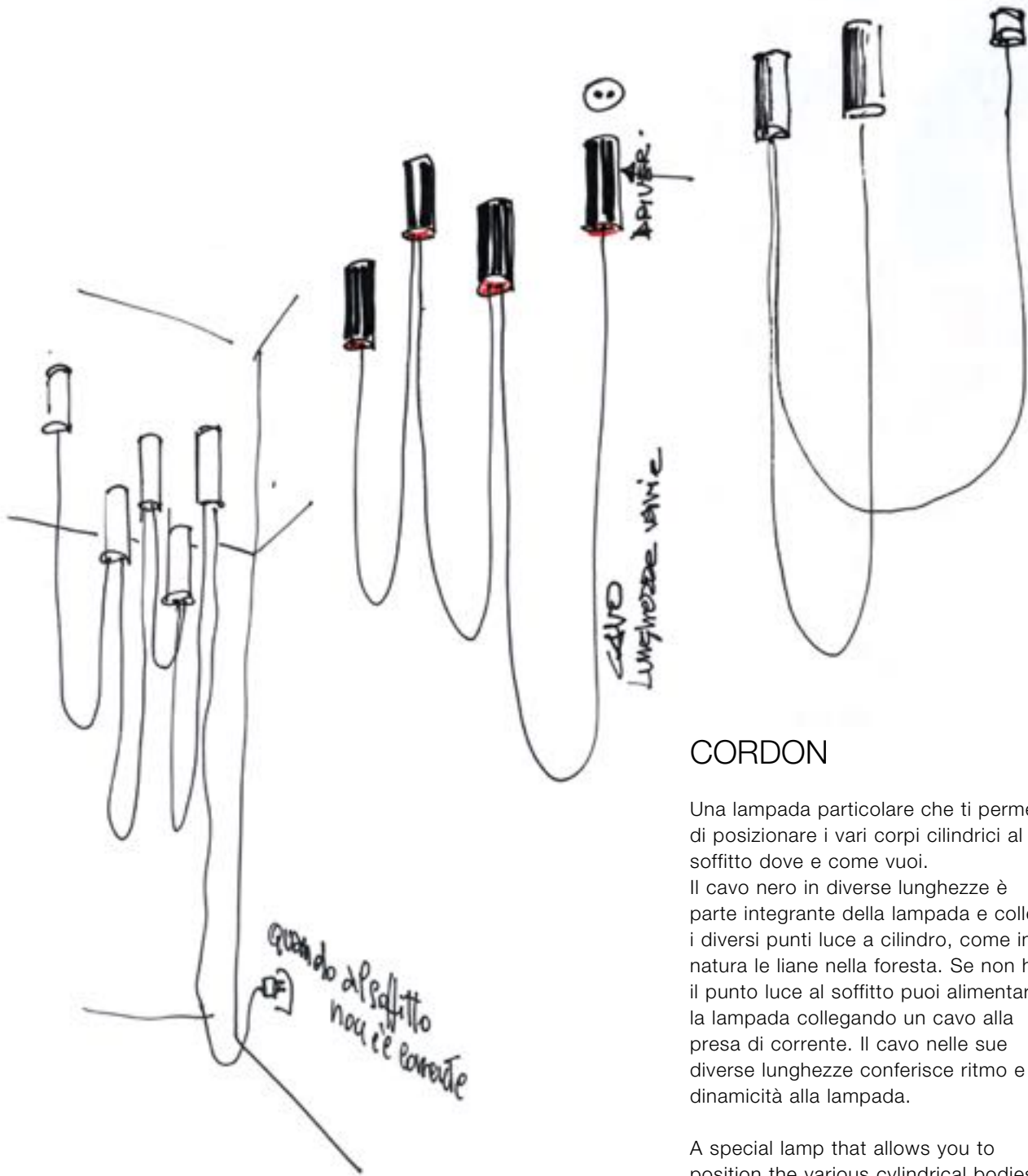

CORDON

Una lampada particolare che ti permette di posizionare i vari corpi cilindrici al soffitto dove e come vuoi.

Il cavo nero in diverse lunghezze è parte integrante della lampada e collega i diversi punti luce a cilindro, come in natura le liane nella foresta. Se non hai il punto luce al soffitto puoi alimentare la lampada collegando un cavo alla presa di corrente. Il cavo nelle sue diverse lunghezze conferisce ritmo e dinamicità alla lampada.

A special lamp that allows you to position the various cylindrical bodies on the ceiling wherever and however you like.

The black cable in different lengths is an integral part of the lamp and connects the different cylinder lights, as in nature the lianas in the forest.

If you do not have a light point to the ceiling you can power the lamp by connecting a cable to the socket. The cable in its different lengths gives rhythm and dynamism to the lamp.

CORDON



SERGE & ROBERT CORNELISSEN

Lampada da soffitto a luce diretta componibile con più elementi cilindrici completi di sorgente di luce LED e alimentatore. Corpi in alluminio verniciato nel colore nero, finitura interna in bianco o rosso. Cavo nel colore nero in due lunghezze e a richiesta secondo la composizione.

Modular direct light ceiling lamp with several cylindrical elements complete with LED light source and driver. Aluminium lamp body painted in black, internal finish in white or red. Cable in black colour in two lengths and on request according to the composition.

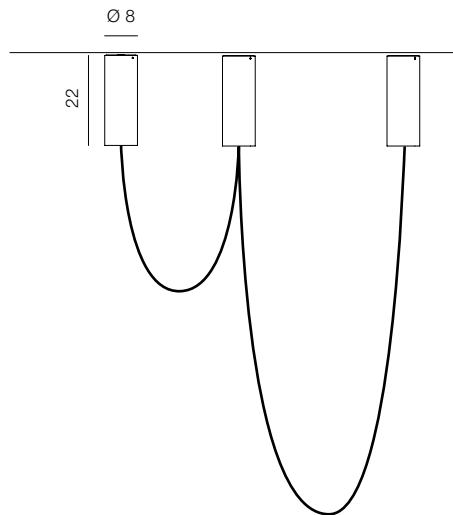

CORPO LAMPADA / LAMP BODY
8,4W LED 1000lm 2700K

40183/NE/RO  nero-rosso / black-red

40183/NE/BI  nero-bianco / black-white

CAVO / CABLE

Kit cavo / Cable kit 3m
40184  nero / black

Kit cavo / Cable kit 5m
40185  nero / black

Kit cavo con spina / Cable kit with plug 5m
40186  nero / black

ROSONE / CEILING ROSE

40187/NE  nero / black



OSTRICA

EMILIANA MARTINELLI



Lampada da soffitto geometrica e minimale a luce diffusa.
Diffusore in vetro opal bianco satinato.
Base in alluminio verniciato nel colore bianco. Sorgente di luce a LED e alimentatore integrati nella base.

Geometric and minimal ceiling lamp providing diffused light.
Satin-finish white opal glass diffuser.
Base in white painted aluminium.
LED light source, driver integrated in the base.

27W LED 3400lm 2700K

2902/BI  bianco / white

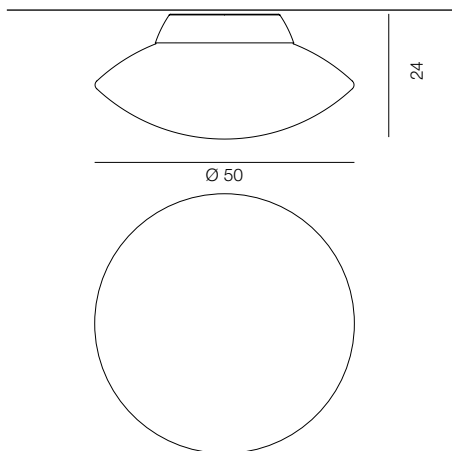





PAPAVERO

Un punto di colore al soffitto o sulla parete per illuminare il tuo spazio con una luce diffusa e giocosa. Il nome, Papavero, per il bottone centrale che è il suo stigma e la fascia colorata la corolla. Voglia di primavera nella mia immaginazione quando ho disegnato questa lampada che della stagione è uno dei simboli.

A point of colour on the ceiling or on the wall to illuminate your space with a diffused and playful light. The name, Papavero (Poppy), was chosen for the central button which is its stigma and the coloured band is its corolla. I felt like spring in my imagination when I designed this lamp, which is one of the symbols of the season.

EMILIANA MARTINELLI

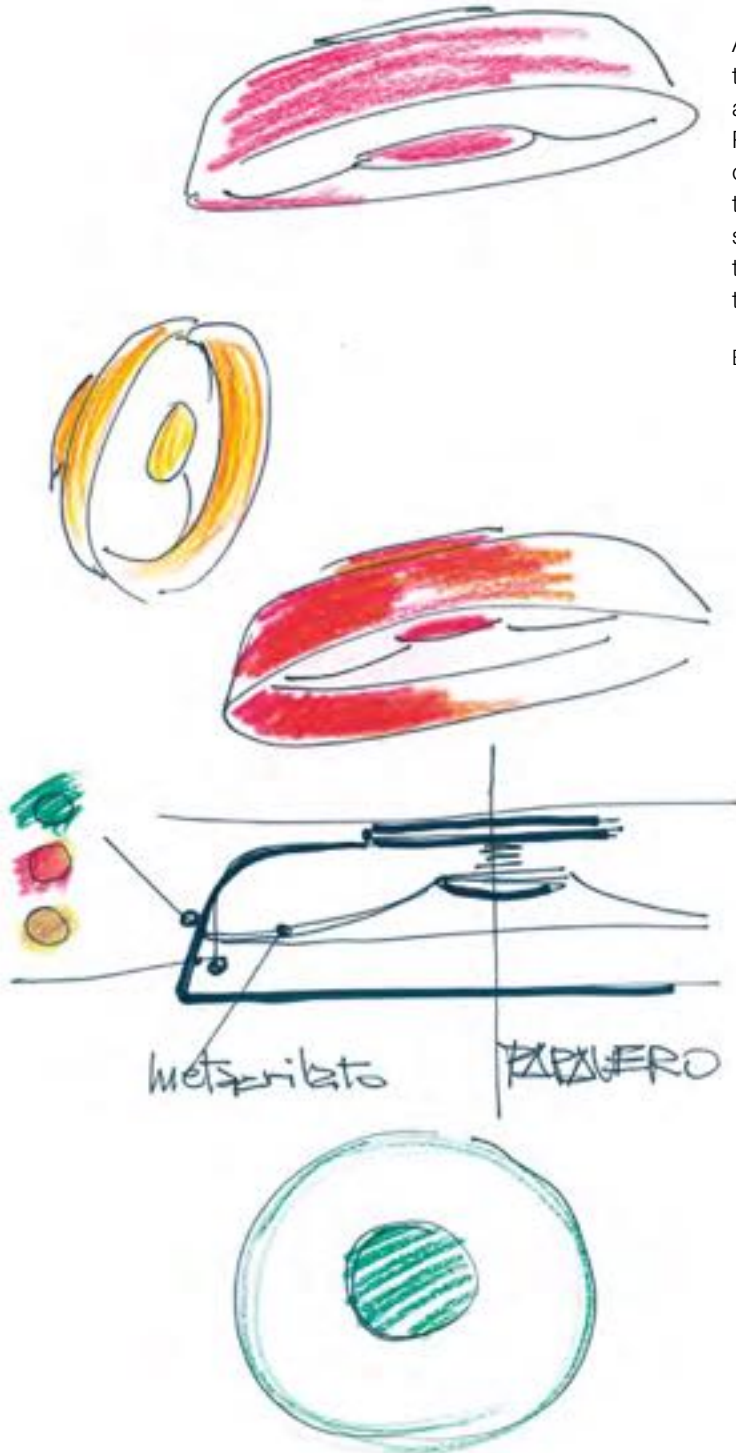

PAPAVERO

EMILIANA MARTINELLI



Lampada da soffitto/parete a luce diffusa.
Struttura in alluminio verniciato nei colori
bianco, giallo, rosso papavero e verde
menta.
Diffusore interno in metacrilato opal bianco.
Sorgente di luce a LED e alimentatori
integrati.
In due dimensioni.

Ceiling/wall lamp providing diffused light.
Painted aluminium structure in white, yellow,
poppy red and mint green. White opal
methacrylate inner diffuser.
Integrated LED light source and driver.
Two sizes.

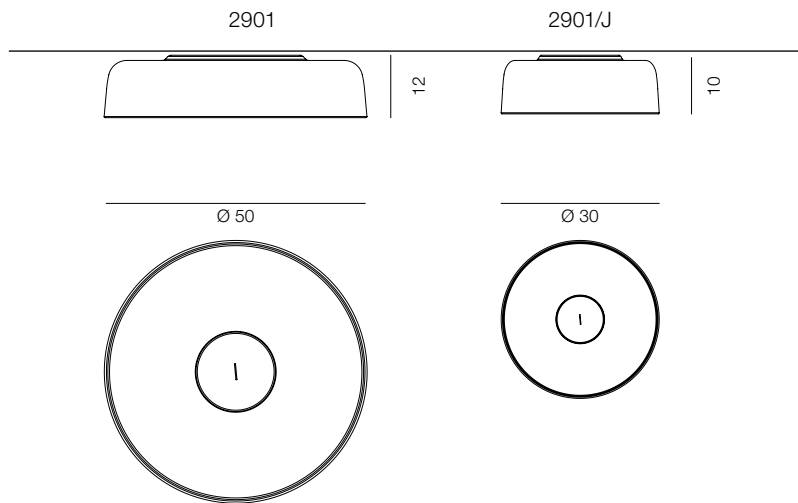

PAPAVERO Ø 50
38W LED 5000lm 2700K

- 2901/BI ○ bianco / white
- 2901/GI ● giallo / yellow
- 2901/RO ● rosso papavero / poppy red
- 2901/VE ● verde menta / mint green

PAPAVERO Ø 30
15W LED 2130lm 2700K

- 2901/J/BI ○ bianco / white
- 2901/J/GI ● giallo / yellow
- 2901/J/RO ● rosso papavero / poppy red
- 2901/J/VE ● verde menta / mint green

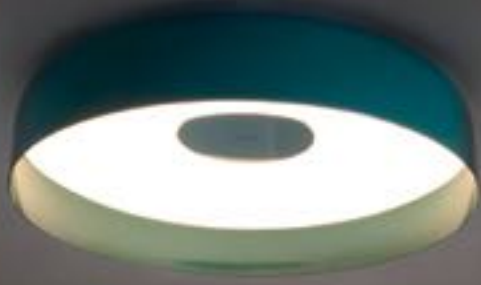



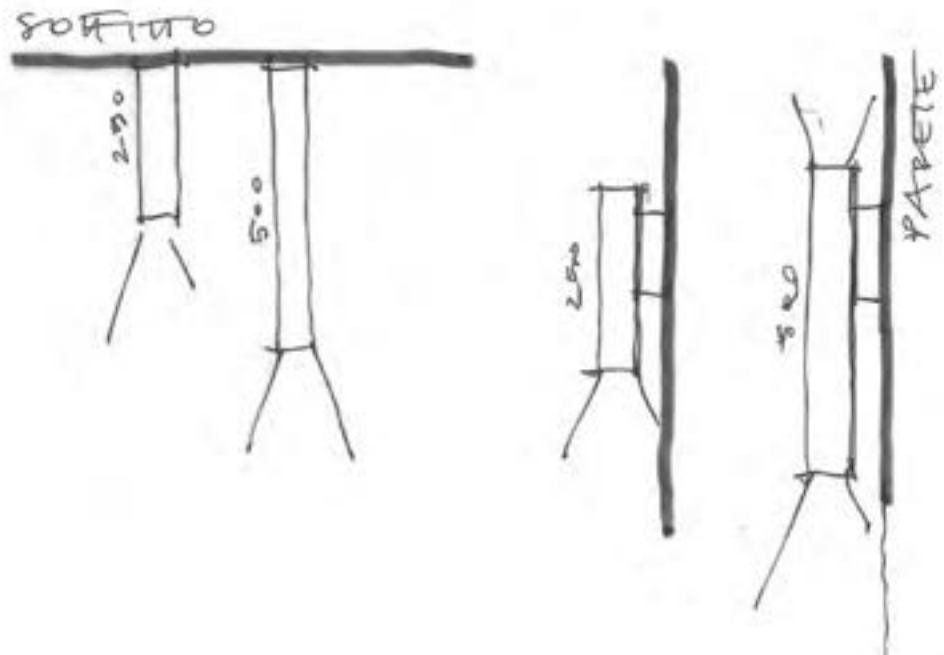

KOKO UNO

Un semplice cilindro, è la forma di questa lampada a luce diretta da soffitto e a sospensione o diretta/indiretta da parete con supporto. Una lampada che crea degli effetti di luce e ombra sulla parete e nell'ambiente.

A simple cylinder is the shape of this direct light ceiling lamp and suspension or direct/indirect wall lamp with stand. A lamp that creates light and shadow effects on the wall and in the room.

PLS DESIGN – LORENZO PERINI
& EMILIANA MARTINELLI

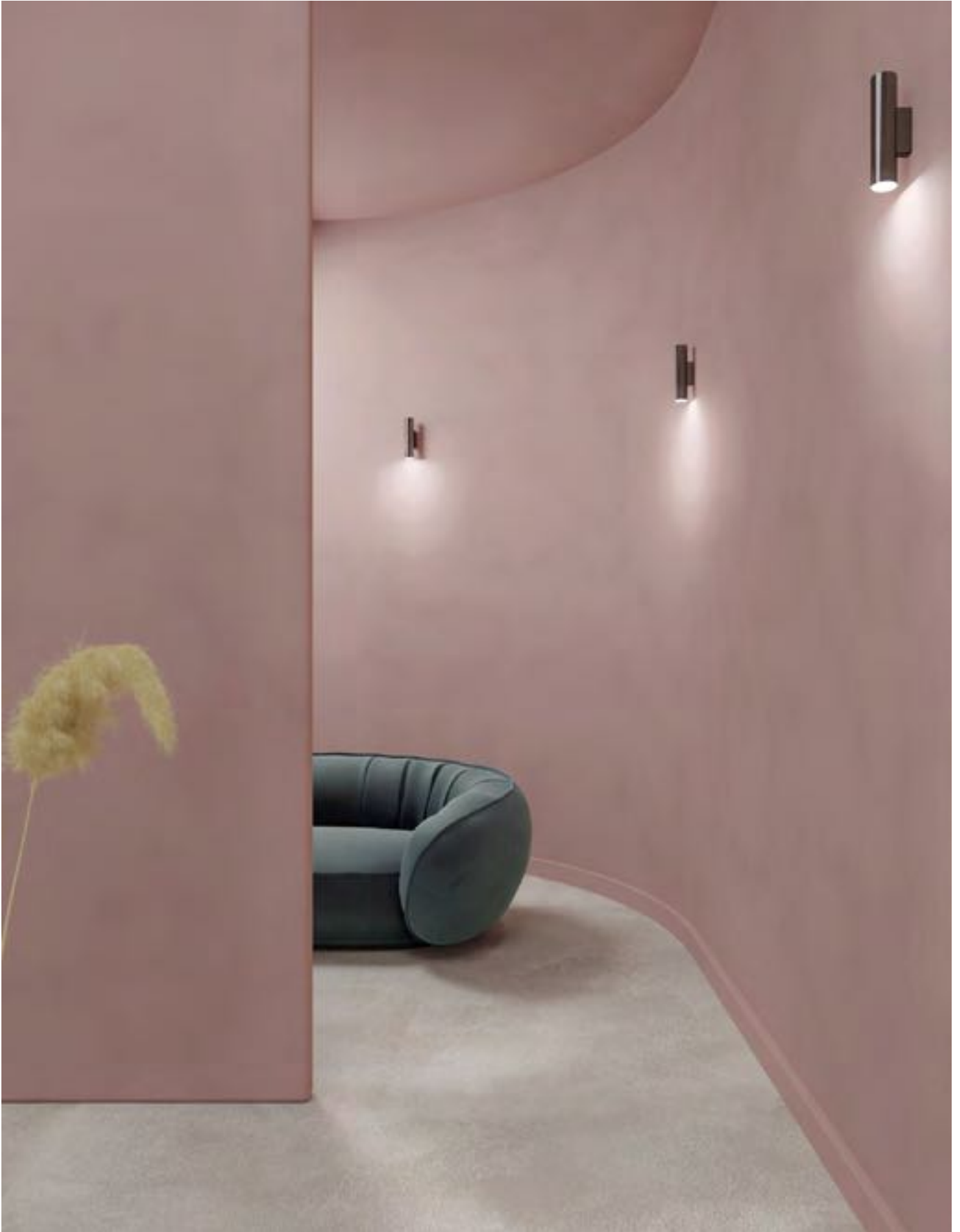



KOKO UNO

PLS DESIGN - LORENZO PERINI
& EMILIANA MARTINELLI

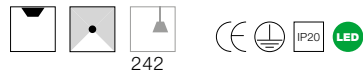

Lampada da soffitto a luce diretta. Struttura in tubolare di alluminio verniciato in diverse finiture.
Sorgente di luce a LED e alimentatore integrati nel corpo lampada.

Ceiling lamp with direct light. Painted aluminum tubular structure in different finishings. LED light source and electronic driver integrated in the body lamp.

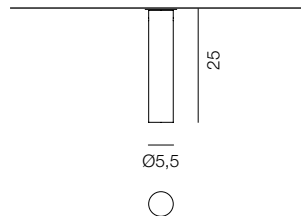

KOKO 25
12W LED narrow 1230lm 3000K

- 2899/BI ○ bianco / white
- 2899/NE ● nero / black
- 2899/AU ● oro perlato / pearly gold
- 2899/CO ● corten / corten



KOKO UNO

PLS DESIGN - LORENZO PERINI
& EMILIANA MARTINELLI



242

Lampada da parete a luce diretta/indiretta (cod. 1454) o a luce diretta (cod. 1454/J). Struttura in tubolare di alluminio verniciato in diverse finiture.

Sorgente di luce a LED e alimentatore integrati nel corpo lampada.

Disponibile in due lunghezze.

Wall lamp with direct/indirect light (cod. 1454) or direct light (cod. 1454/J). Structure in painted tubular aluminium in different finishes.

LED light source and electronic driver integrated in the body lamp.

Available in two lengths.

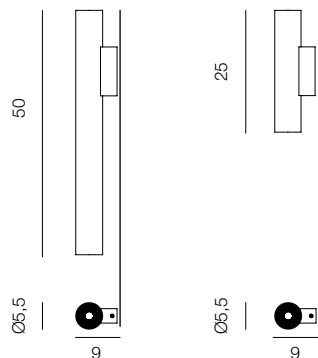

1454

1454/J

KOKO 50

2x12W LED narrow 2x1230lm 3000K
luce diretta-indiretta/direct-indirect light

1454/BI  bianco / white

1454/NE  nero / black

1454/AU  oro perlato / pearly gold

1454/CO  corten / corten

KOKO 25

12W LED narrow 1230lm 3000K
luce diretta/direct light

1454/J/BI  bianco / white

1454/J/NE  nero / black

1454/J/AU  oro perlato / pearly gold

1454/J/CO  corten / corten



DELUX J

STUDIO NATURAL & EMILIANA MARTINELLI



56

Una piccola lampada da soffitto a luce diffusa. Struttura in alluminio verniciato nel colore bianco, nero, ottone e corten. Diffusore in vetro soffiato opal bianco. Per sorgente di luce a LED.

Little ceiling lamp with diffused light. Aluminium structure painted in white, black, brass and corten. Opal blanc blown glass diffuser. For LED light source.

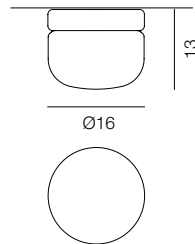

10W LED 1000lm 2700K

2900/J/BI ○ bianco / white

2900/J/NE ● nero / black

2900/J/OT ● ottone / brass

2900/J/CO ● corten / corten



GLOBO

ELIO MARTINELLI



Una lampada da soffitto a luce diffusa con base per il fissaggio al soffitto in metallo verniciato nel colore bianco. Diffusore in vetro soffiato trasparente e sabbiato. Per lampadina a LED.

A ceiling lamp providing diffused light with a base for fixing to the ceiling in white painted metal. Transparent and sandblasted blown glass diffuser. For LED bulb.

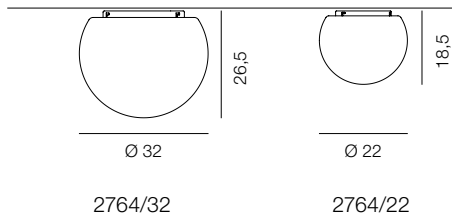

15W E27 LED

2764/22/BI bianco / white

2764/32/BI bianco / white



COMIC ART
JULIAN SCHRÄDEL



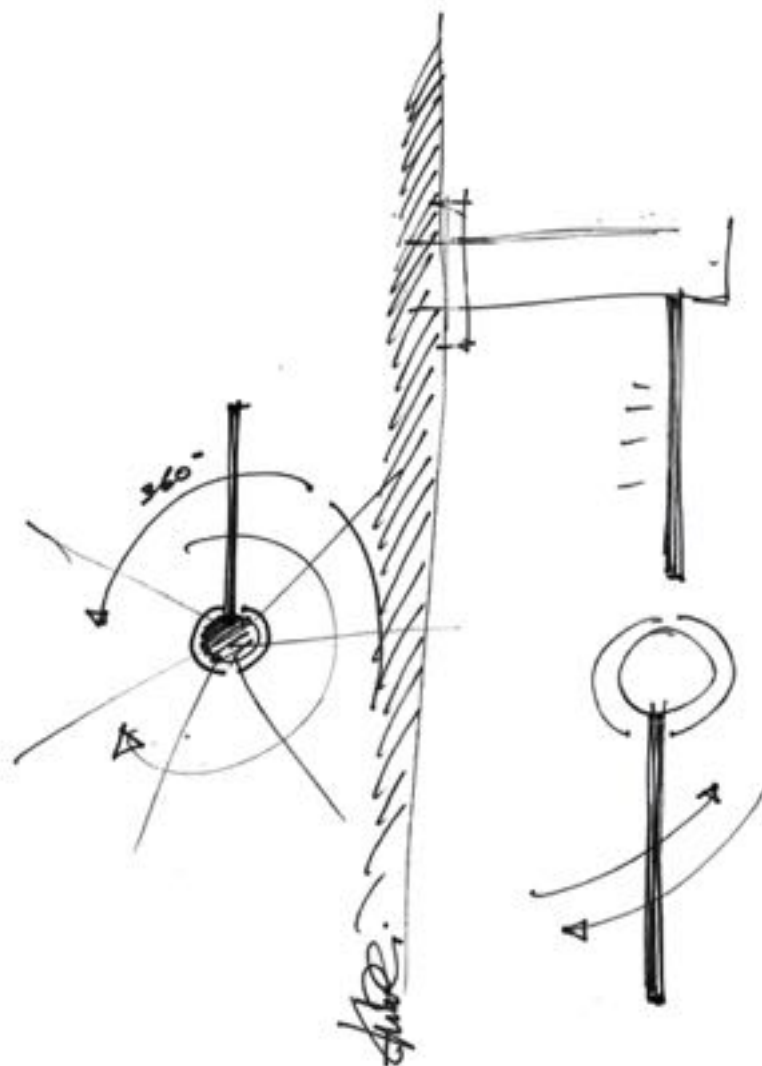

MOSCA

Un giorno, aiutando Anna, la mia nipote, a fare una ricerca sugli insetti per il compito di Scienze, mi soffermai sulla mosca. È stato proprio il piccolo dittero che ha fatto scaturire nella mia fantasia l'idea di questa lampada. Il suo corpo, ridotto all'essenziale, diventa un cilindro in alluminio nel colore nero; un elemento tubolare stretto e lungo che supporta la sorgente luminosa e ruota come la testa con la sua lunga proboscide. La Mosca si riposa di giorno, ma di notte si fa notare come piccolo segno sulle pareti creando simpatici effetti luminosi orientabili. Segni divertenti, non noiosi, che però non devono essere schiacciati...

One day, while helping Anna, my granddaughter, to do a research on insects for her science homework, I focused on the fly. It was precisely this little dipteran that inspired me to come up with the idea for this lamp. Its body, reduced to its essentials, becomes an aluminium cylinder in black; a long, narrow tubular element that supports the light source and rotates as the head recalls the long proboscis. The fly rests during the day, but at night it stands out as a small sign on the walls, creating attractive adjustable lighting effects. Fun, not boring, signs, but they must not be squashed...

EMILIANA MARTINELLI





MOSCA

EMILIANA MARTINELLI



Un piccolo segno luminoso sulla parete, a luce indiretta, che ruota sul corpo tubolare. Struttura in alluminio verniciato nel colore nero. Sorgente di luce a LED. Alimentatore elettronico 5W integrato nel corpo lampada.

A tiny luminous speck on the wall, rotating on a tubular body to provide indirect lighting. Structure in aluminum painted black color. LED light source. Integrated in the body lamp 5W electronic driver.

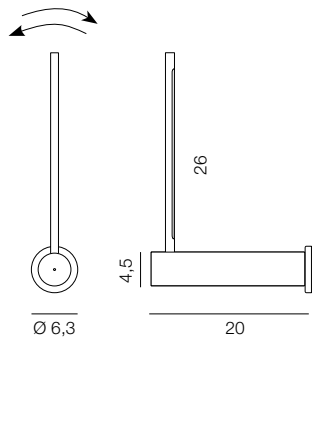

MOSCA L20 integrated driver
3W LED 500lm 3000K

1445/NE ● nero / black



MAGGIOLONE

EMILIANA MARTINELLI



Lampada da soffitto a luce diffusa, con sorgente di luce a LED. Struttura in alluminio verniciato nel colore bianco, nero o giallo. Diffusore in metacrilato opal bianco. Alimentatore elettronico dimmerabile Push/Dali2 all'interno della base di attacco al soffitto. Disponibile anche nella versione a sospensione in due dimensioni.

Diffused-light ceiling lamp with LED light source. Structure in aluminum painted in white, black or yellow color. White opal methacrylate diffuser. Push/Dali2 dimmable electronic driver incorporated in the ceiling base. Also available in the suspension version in two sizes.

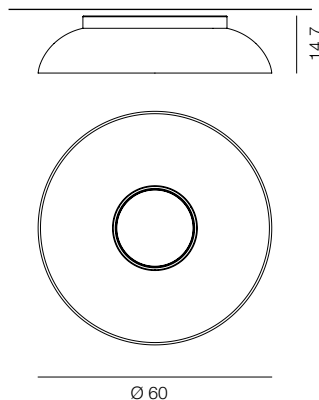

26W LED 3200lm 2700K

2891/DIM/2700/BI ○ bianco / white

2891/DIM/2700/NE ● nero / black

2891/DIM/2700/GI ● giallo / yellow

26W LED 3200lm 3000K

2891/DIM/BI ○ bianco / white

2891/DIM/NE ● nero / black

2891/DIM/GI ● giallo / yellow







LED+O

Una lampada da parete a luce indiretta la cui geometria è il risultato di un attento esercizio di sottrazione nella ricerca dell'essenziale, volto a creare un oggetto "leggero" da poter inserire in qualsiasi spazio.

Il circuito LED è alloggiato nel corpo dell'apparecchio realizzato in alluminio pressofuso che grazie alla sua doppia concavità garantisce una perfetta distribuzione della luce e permette alla lampada di assumere geometrie uniche da ogni prospettiva.

La pulizia formale e l'estrema facilità di installazione rendono questo prodotto particolarmente adatto anche per l'ambiente contract.

Indirect light wall lamp, its geometry is the result of a careful exercise of subtraction looking for essential, direct to create an object mild to stay on every environment. LED circuit is inside aluminium diecast corp that thanks to its double concavity guarantees a perfect distribution of light and permitted that lamp takes unique geometries from every perpespective. The formal clean and the extreme easier for installation make become this product particular also to put it in a conctract ambient.

STUDIO NATURAL

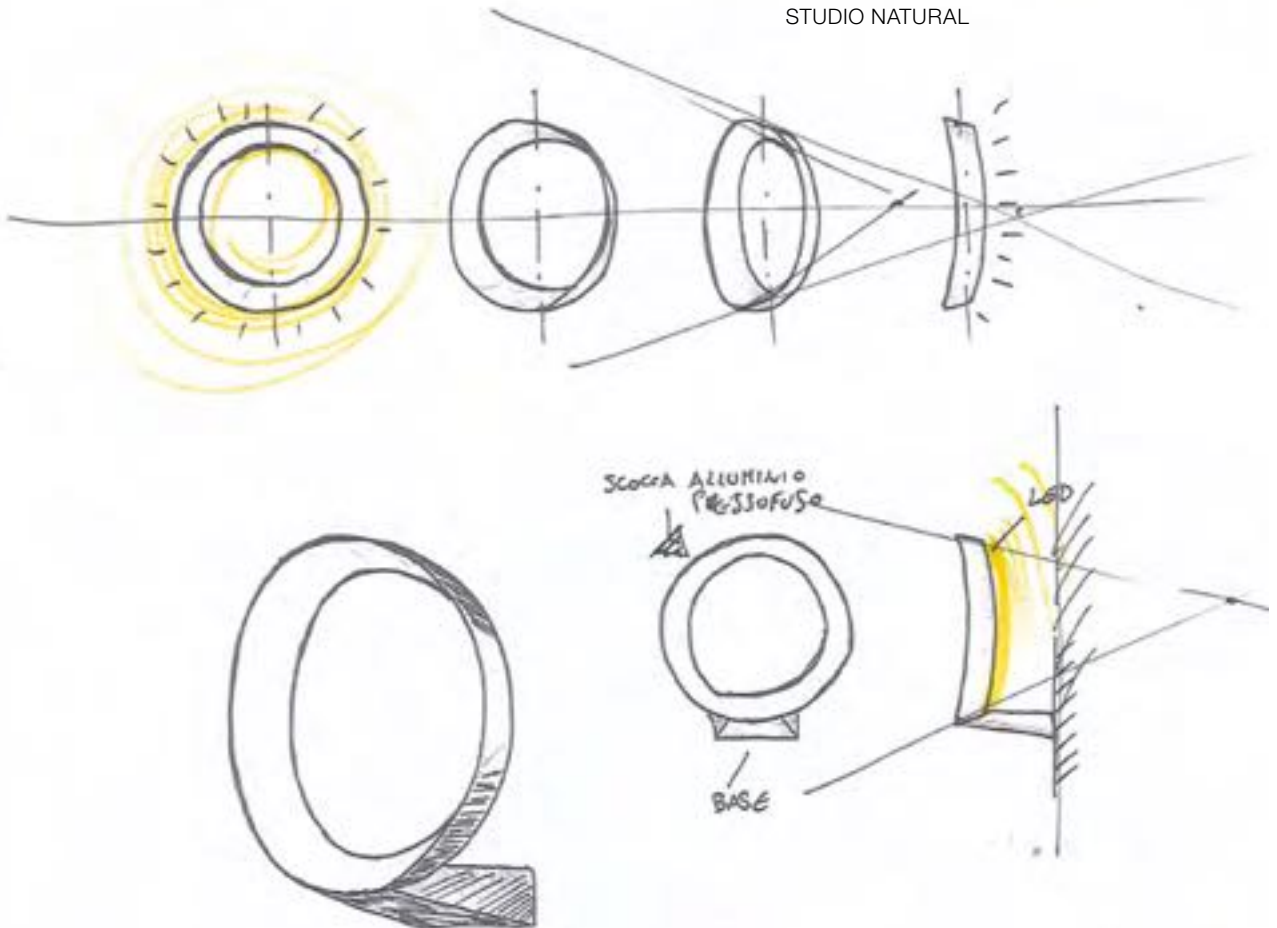

Studio Natural

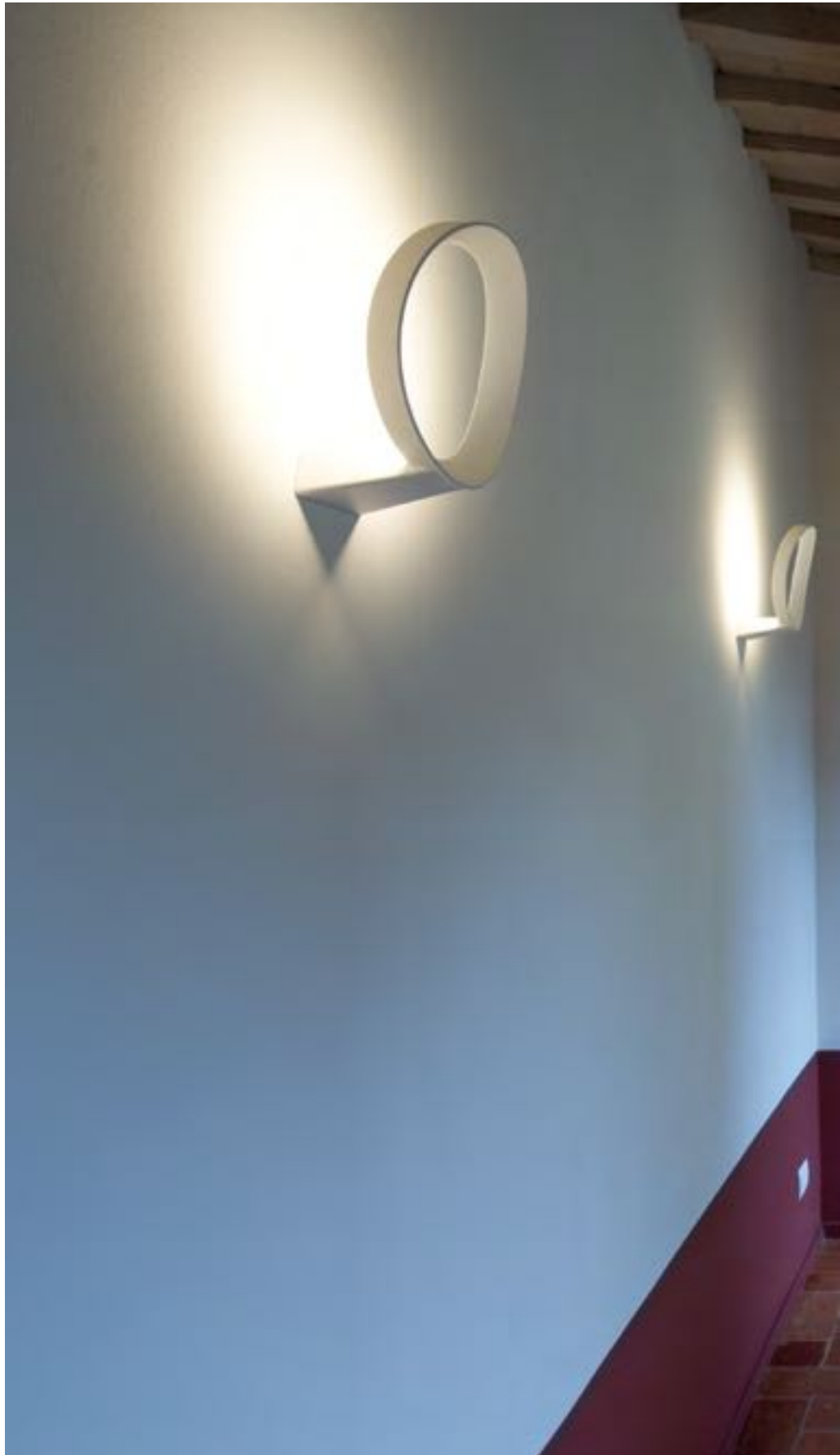



LED+O

STUDIO NATURAL



Lampada da parete a luce indiretta.
Struttura in estruso di alluminio verniciato
nel colore bianco o oro perlato.
Per sorgente di luce a LED.
Alimentatore elettronico dimmerabile
integrato nel corpo lampada.

Wall lamp indirect light. Structure of cast
aluminium, painted in white or pearly gold
color. For LED light source.
Electronic dimmable driver integrated into
the body lamp.

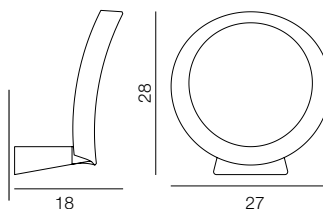

NON DIMMERABILE / NON DIMMABLE
21,6W LED 2900lm 2700K

1434/2700/BI bianco / white

DIMMERABILE / DIMMABLE 1-10V
18,6W LED 2900lm 2700K

1434/DIM/2700/BI bianco / white

DIMMERABILE / DIMMABLE TRIAC
18,6W LED 2900lm 2700K

1434/DIM/T/BI bianco / white







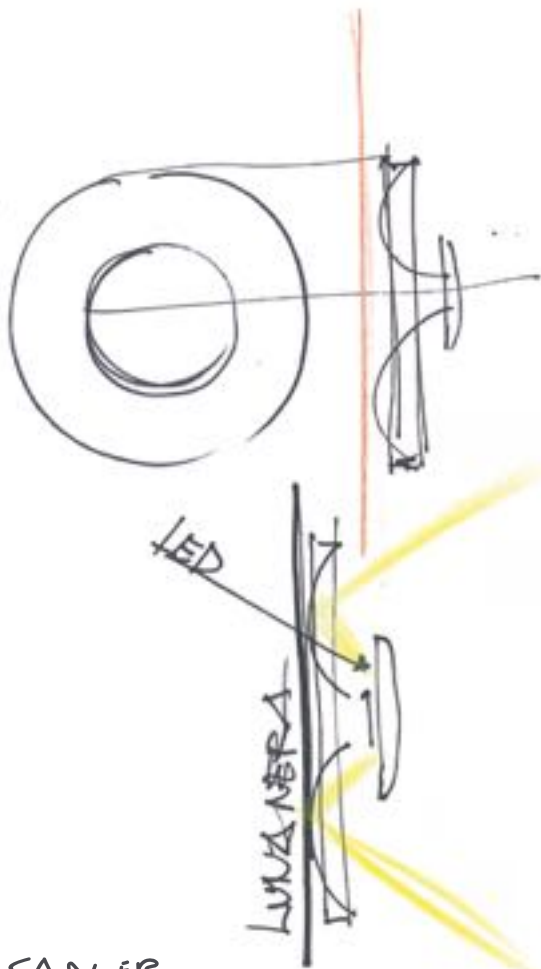
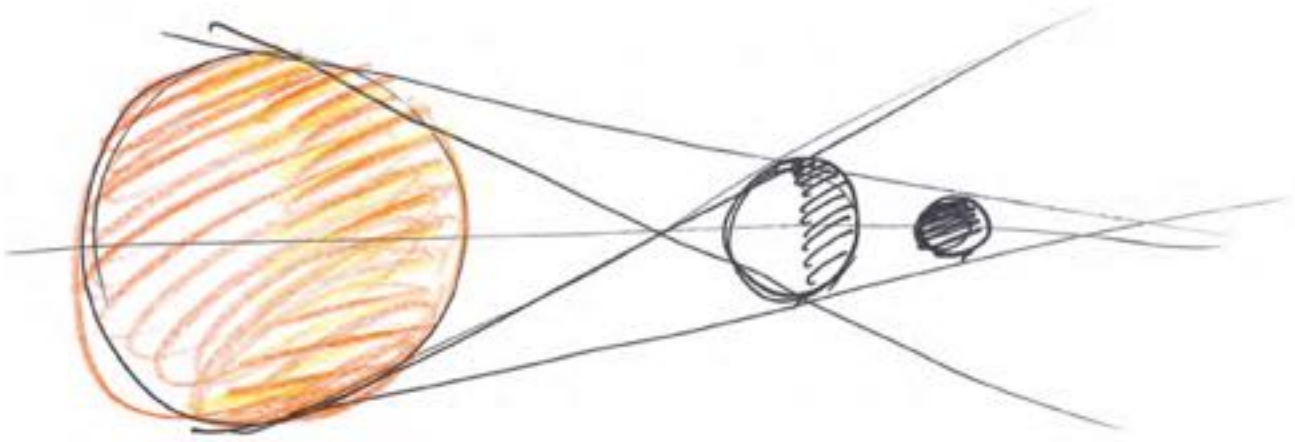

SADLER

LUNA NERA

Lunamera ricrea l'effetto ottico dell'eclissi di luna, in un fugace abbraccio tra luce e oscurità che dà vita ad un bagliore misterioso e affascinante. L'interposizione dei pianeti con un rimando alla mitologia che identifica nella luna l'elemento principe nella formazione dei miti.

Lunamera recreates the optical effect of the eclipse of the moon in a fleeting embrace between light and darkness that gives life to a mysterious and fascinating glow. The interposition of the planets with a hint at mythology that identifies in the moon the principal element in the creation of myths.

MARC SADLER

LUNA NERA

MARC SADLER



Lampada da parete o da soffitto a luce indiretta. Struttura in alluminio verniciato nel colore bianco e diffusore in policarbonato. Sorgente di luce a LED integrato e alimentatore elettronico inserito all'interno del corpo lampada.

Wall or ceiling lamp indirect light. White painted aluminium structure and polycarbonate diffuser. Integrated LED light source and electronic driver inside the body lamp.

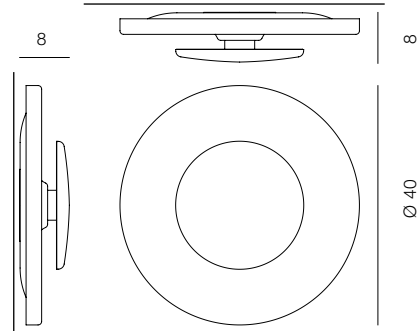

15W LED 1860lm 3000K

1437/BI ○ bianco / white



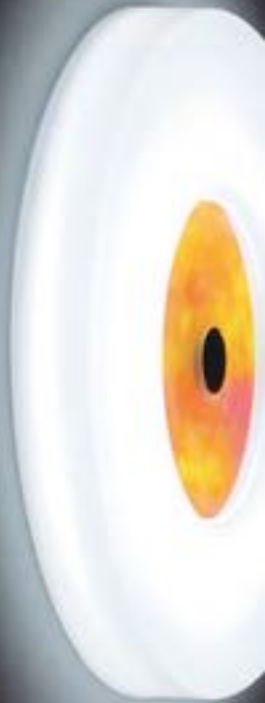

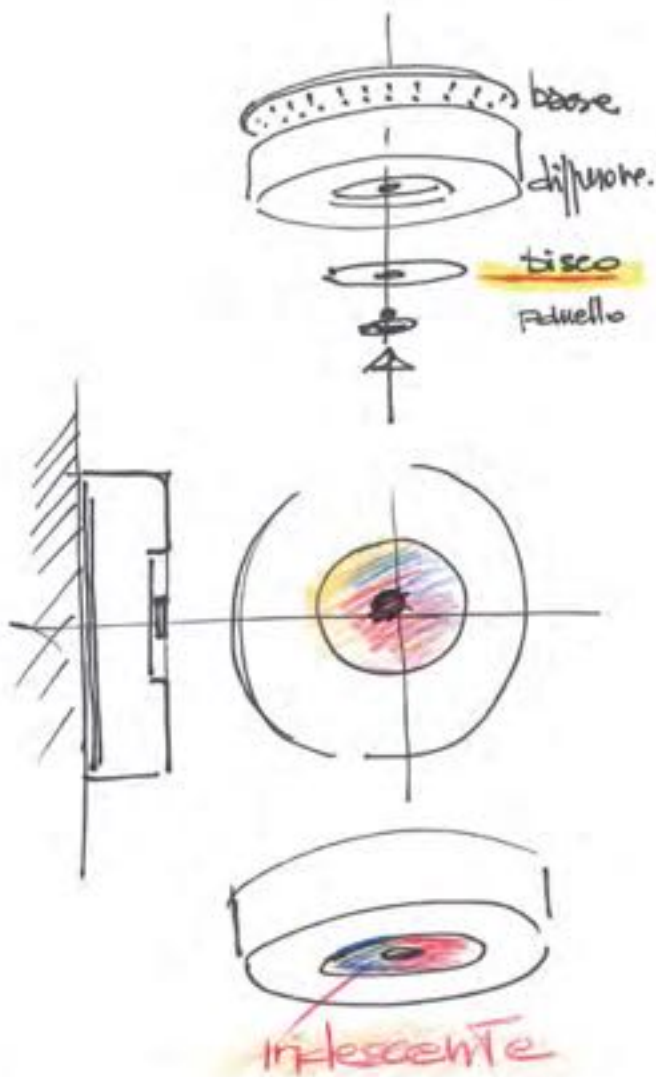

CORONA 4 misure.
 \varnothing 85/60/42/28

CORONA

Una lampada a luce diffusa dalla semplice forma circolare, che non ti stancherà mai, caratterizzata da un elemento centrale in metacrilato iridescente che cambia colore secondo il tuo punto di vista, azzurro, giallo, fucsia, arancio... multicolor.

A lamp with diffused light in a simple round shape that never tires it is characterized by a central element in iridescent methacrylate that changes color based on your position: blue, yellow, fuchsia, orange... multicolor.

EMILIANA MARTINELLI

CORONA

EMILIANA MARTINELLI



Lampada da parete o soffitto a luce diffusa. Diffusore in metacrilato opal bianco, base in alluminio verniciato nel colore bianco, disco centrale in metacrilato iridescente, bottone di bloccaggio in metallo verniciato. Sorgente di luce a LED integrato completo di alimentatore elettronico. Disponibile in quattro misure.

Wall or ceiling lamp, diffused light. Diffuser in white opal methacrylate. Base in white painted aluminium, central disc made of iridescent methacrylate, central button in painted metal.

LED light source integrated, equipped with electronic driver. Available in four sizes.

CORONA Ø 42
26W LED 3200lm 3000K

2834/M/L/1 ○ bianco / white

CORONA Ø 28
15W LED 1500lm 3000K

2834/M/J/L/1 ○ bianco / white

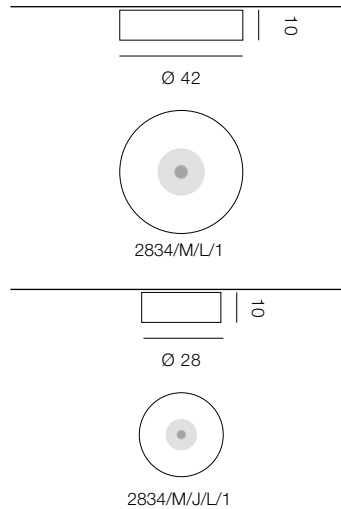



PIN

MICHEL BOUCQUILLON



340

Lampada da soffitto o da parete a luce diffusa. Struttura stampata in rotazionale, materiale polietilene bianco, particolari in alluminio verniciato nel colore bianco. Per lampadina a LED. Disponibile anche nella versione da terra. Altre lunghezze come in foto a richiesta.

Wall or ceiling lamp, diffused light, rotational moulded, white polyethylene material, support in white painted aluminium. For LED bulb. Available also in the floor version. Other lengths as in the picture on request.

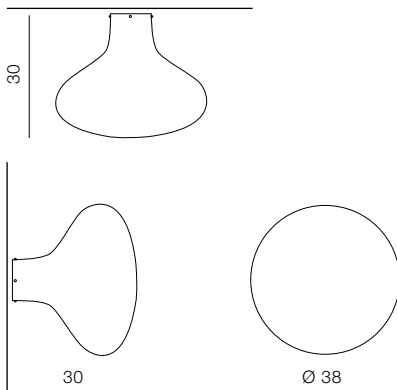

1x15W E27 LED

2880/30 ○ bianco / white



Altre lunghezze come in foto a richiesta.
Other lengths as in photo on request.





Lucciola

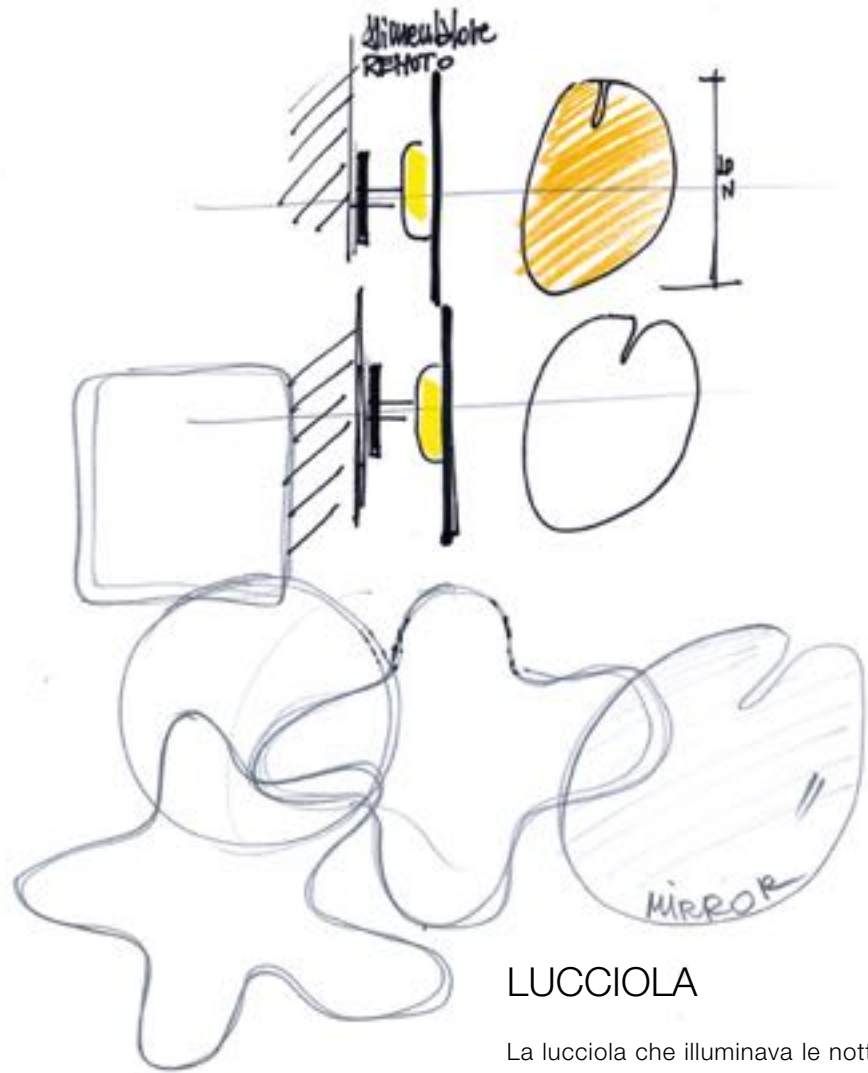

LUCCIOLA

La lucciola che illuminava le notti delle mie estati, è stata l'ispirazione per questa lampada da parete e ho cercato con la sua forma stilizzata di farla rivivere in casa per ricordare quei momenti di felicità. Da sola o disposta sulla parete in gruppo, nei vari colori, crea il movimento e dei divertenti giochi di luce ed ombra.

The firefly ("lucciola" in Italian) that lit up the nights of my summers was the inspiration for this wall lamp and I have tried with its stylised shape to bring it back to life in the home to recall those happy moments. Alone or arranged on the wall in groups, in various colours, it creates movement and a fun play of light and shadow.

EMILIANA MARTINELLI





LUCCIOLA

EMILIANA MARTINELLI



Lampada da parete a luce indiretta.
Schermo in alluminio verniciato nel colore
bianco, giallo o a specchio.
Diffusore in metacrilato opal bianco.
Sorgente di luce a LED integrata.

Wall lamp indirect light. White, yellow
painted aluminium screen or in mirror.
White opal methacrylate diffuser.
Integrated LED light source.

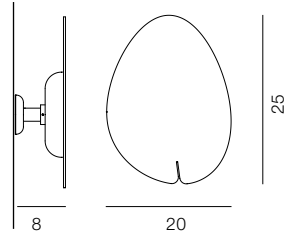

15W LED 230V 2300lm 3000K

1431/230/BI  bianco / white

1431/230/GI  giallo / yellow

1431/230/MS  specchiato / mirrored





SET



EMILIANA MARTINELLI

Serie di apparecchi a parete a luce diretta/indiretta. Struttura in alluminio verniciato, diffusore in vetro satinato. Per sorgente di luce a LED. Completo di alimentatore elettronico. Disponibile in tre dimensioni.

Wall lamps direct/indirect light. Painted aluminium structure, with satin glass diffuser. For LED light source. Complete of electronic driver. Available in 3 sizes.

SET 17,5
18W LED 2600lm 3000K

- 1341/L/1/BI bianco / white
- 1341/L/1/NE nero / black
- 1341/L/1/AU oro perlato / pearly gold
- 1341/L/1/CU rame / copper

SET 35,5
24W LED 3770lm 3000K

- 1342/L/1/BI bianco / white
- 1342/L/1/NE nero / black
- 1342/L/1/AU oro perlato / pearly gold
- 1342/L/1/CU rame / copper

SET 70
48W LED 7540lm 3000K

- 1343/L/1/BI bianco / white
- 1343/L/1/NE nero / black
- 1343/L/1/AU oro perlato / pearly gold
- 1343/L/1/CU rame / copper

1341/L/1/BI

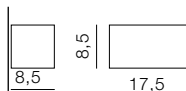

1342/L/1/BI

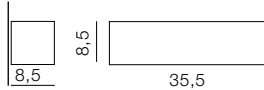

1343/L/1/BI

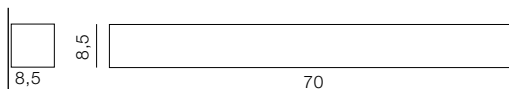





LE RONDINI



Un giorno di primavera, ero a Ciciano nella casa di campagna sulle colline che circondano Lucca. Una visuale bellissima sulla valle, lontano il fiume Serchio con le sue anse sinuose e la città con le sue alte torri avvolta nella nebbiolina mattutina.

Mio padre mi svegliò presto, fai svelta mi disse, vedrai una cosa fantastica, vieni alla finestra. Era la finestra della sua camera e uno spettacolo entusiasmante e allegro si aprì davanti a noi: erano arrivate le rondini, tante, tantissime. Si erano posate una accanto all'altra, sul filo della luce teso tra i pali alti nel prato, e tante si rialzavano in volo svolazzando felici, come impazzite. Volavano a scatti, scendevano in picchiata, intorno e nell'azzurro come in un ballo rock; i loro garriti inondavano felici tutta la collina. Una scena bellissima e un bellissimo ricordo ripensando a quella mattina del 1984, e con noi anche mia madre, assorta nel vedere un simile ed unico spettacolo.

Ma iniziò il bello... dobbiamo fare la lampada, memorizza disse mio padre, attenta, oggi, ...subito, come di solito avveniva dopo che l'idea si era presentata. Così quel giorno in azienda mi trovai a studiare la rondine, sintetizzare la sua forma, studiare un sistema di attacco, preparare il prototipo. Le Rondini nacquero sul filo...

One spring day, I was in Ciciano in the country house on the hills that surround Lucca. A beautiful view of the valley: far away the Serchio river with its winding bends and the city with its high towers shrouded in morning mist. My father woke me up early - hurry up - he said, you'll see something amazing - come to the window! He was at his bedroom window and an exciting and cheerful sight opened up right in front of us: the swallows had arrived and there were so many of them. They perched side by side on the light line stretched between the high poles in the grass, and so many rose into the air fluttering happily, as if they had gone mad. They flew in jerks, swooping down, around and in the blue like a rock dance. Their chirping filled the valley with happiness. A beautiful scene and a beautiful memory, when I think back to that morning in 1984, and with us also my mother, absorbed in seeing such a unique spectacle.

But the fun began... "we have to make a lamp, memorize" - my father said - "careful, today, ...right away", as was usually the case after the idea had presented itself. So that day in the company I found myself studying the swallow, synthesising its shape, studying an attachment system, preparing the prototype. The swallows were born on the line...

ELIO MARTINELLI





LE RONDINI

ELIO MARTINELLI



Lampada da parete composta da due conduttori cromati fissati a due supporti in metallo verniciato nel colore bianco da fissare a parete e da tre rondini in alluminio verniciate nel colore bianco e nero posizionabili a piacere sui due conduttori, cablate per sorgente di luce a LED. Completo di gruppo di alimentazione 230/24V nella scatola in alluminio verniciato nel colore bianco da fissare a parete.

Wall lamp composed by the chromed conductors fixed to 2 support in white painted metal, to fix the wall and by three swallows in painted aluminium in white and black color, which can be positioned on two conductors on wired for LED light source. Complete of electronic driver 230/24V inside the wall stud in white painted aluminium.

3x5W 12V GY 6,35 LED

1249/3/L/1  bianco-nero / white-black

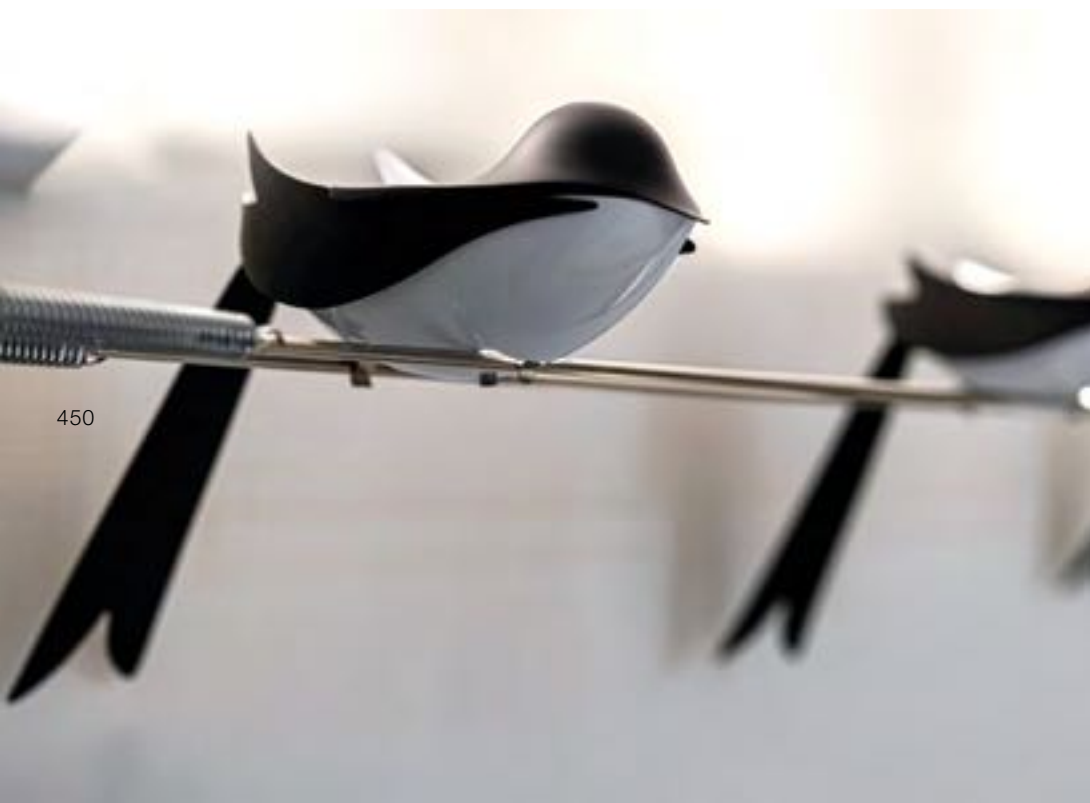
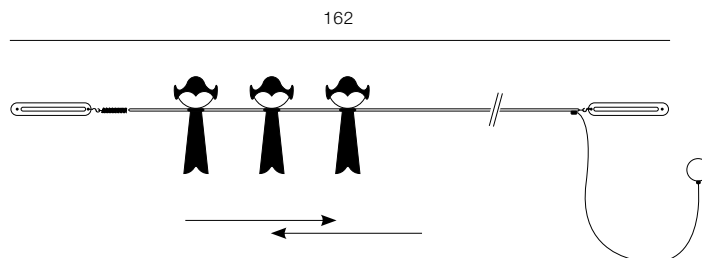



TUBE

ELIO MARTINELLI



Lampada da parete a luce diretta/indiretta o diffusa. Base in resina e riflettore in alluminio verniciato, nel colore bianco o nella versione con diffusore in vetro satinato.

Per lampadina a LED.

Disponibile in due dimensioni.

Wall lamp direct/indirect light or diffused. Support in resin and aluminium reflector in white painted colour or in the version with satin glass diffuser.

For LED bulb.

Available in two sizes.

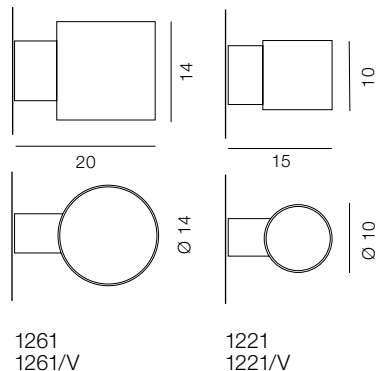

1261
1261/V

1221
1221/V

TUBE Ø 14
10W E27 LED

Riflettore in alluminio / Aluminium reflector

1261/BI ○ bianco / white

Diffusore in vetro satinato / Satin glass diffuser

1261/V/BI ○ bianco / white
vetro / glass

TUBE Ø 10
7W E27 LED

Riflettore in alluminio / Aluminium reflector

1221/BI ○ bianco / white

Diffusore in vetro satinato / Satin glass diffuser

1221/V/BI ○ bianco / white
vetro / glass



GOMITO

ELIO MARTINELLI



Lampada da parete a luce diretta o indiretta. Struttura in resina verniciata nel colore bianco.
Per lampadina a LED.

Wall lamp direct or indirect light. White painted color resin structure.
For LED bulb.

10W E27 LED

1196/BI  bianco / white

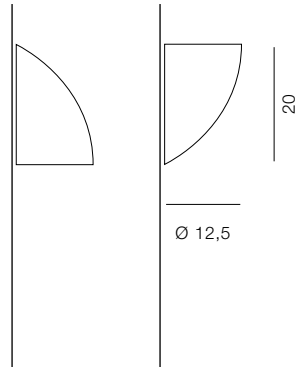



POUFF



EMILIANA MARTINELLI

Lampada da soffitto o da parete a luce diffusa. Base in alluminio verniciato nel colore bianco, diffusore in metacrilato opal bianco. Sorgente di luce a LED, alimentatore elettronico all'interno del corpo lampada.

Disponibile in due dimensioni.

Ceiling or wall lamp diffused light. Aluminium base painted in white colour. White opal methacrylate diffuser. LED light source. Electronic driver included inside the body lamp. Available in two sizes.

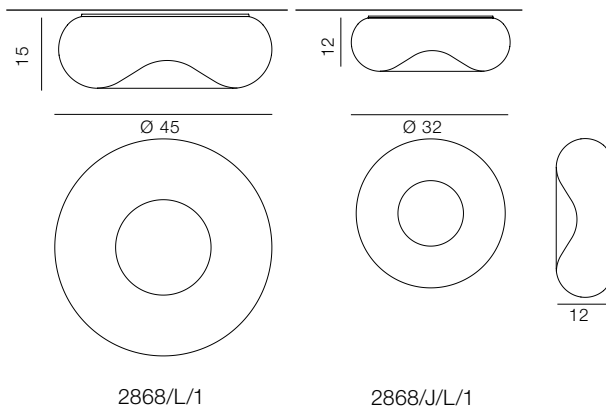

POUFF Ø 45
18W LED 2220lm 3000K
2868/L/1 ○ bianco / white

POUFF Ø 32
15W LED 1700lm 3000K
2868/J/L/1 ○ bianco / white





SEMISFERA

ELIO MARTINELLI



Lampada da soffitto o parete a luce diffusa, per sorgente di luce a LED. Diffusore in metacrilato opal bianco. Base di attacco in alluminio verniciata nel colore bianco con particolari supporti a scatto per il fissaggio del diffusore. Alimentatori elettronici all'interno del corpo lampada. Disponibile in due dimensioni.

Ceiling or wall lamp diffused light, for LED light source. Diffuser in white opal methacrylate. Base in aluminium painted in white colour with particular fixing support to diffuser. Electronic drivers inside the body lamp. Available in two sizes.

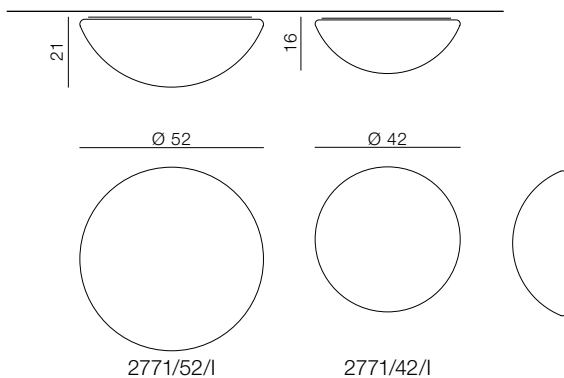

SEMISFERA Ø 52
15,5W E27 LED 1520lm 3000K

2771/52/1 ○ bianco / white

SEMISFERA Ø 42
15,5W E27 LED 1520lm 3000K

2771/42/1 ○ bianco / white





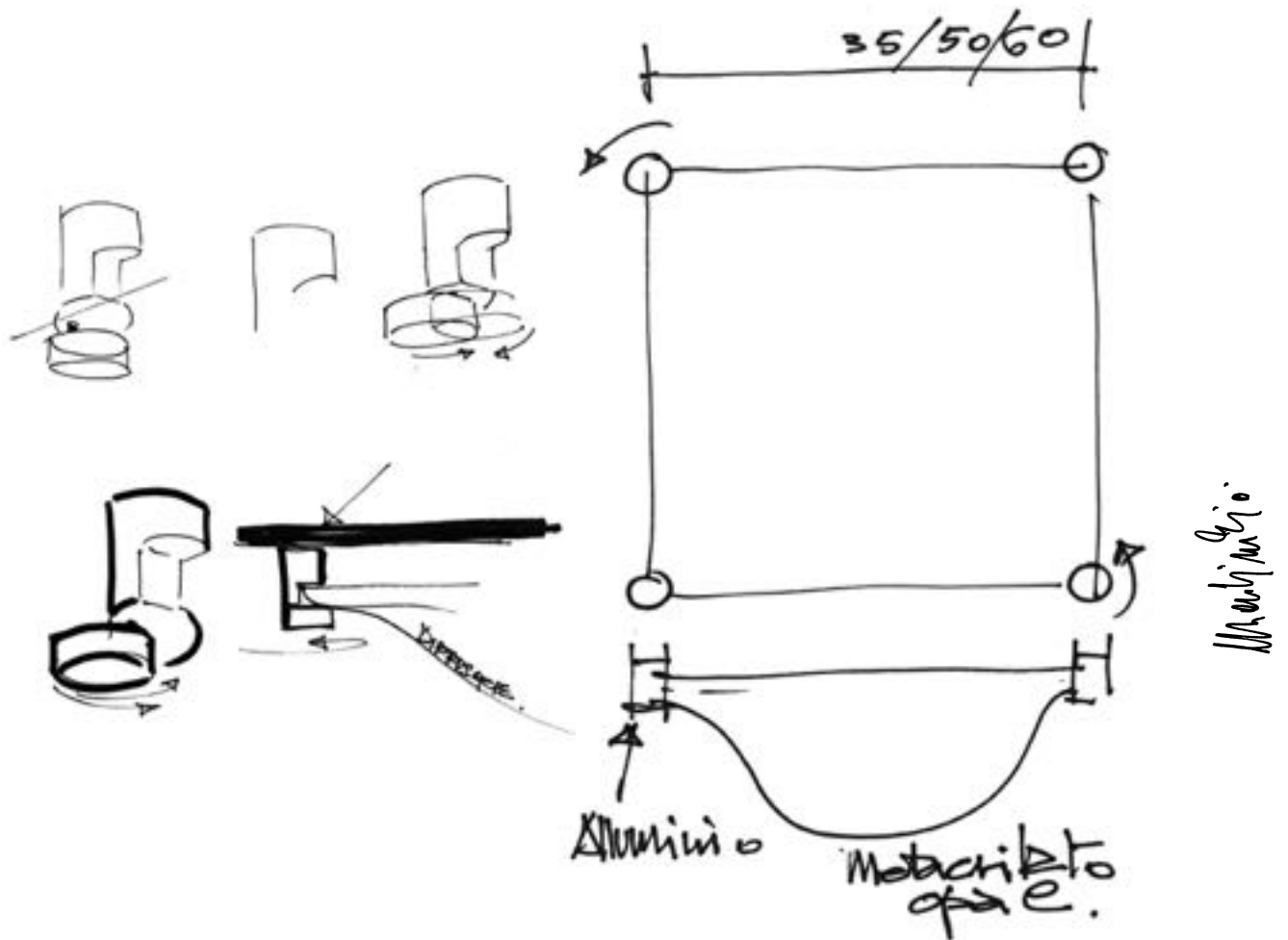

BOLLA

Una goccia d'acqua sembra cadere dal soffitto. Tante gocce vicine l'una a l'altra ricordano un vetro bagnato.

Il foglio di metacrilato stampato ha preso vita!

La luce è diffusa e le ombre giocano con i piedini di fissaggio del diffusore alla base quadrata.

Disponibile in tre dimensioni.

A drop of water seems to fall from the ceiling. Many drops close to each other resemble wet glass. The printed methacrylate sheet has come to life!

The light is diffused and the shadows play with the feet fixing the diffuser to the square base.

Available in three sizes.

ELIO MARTINELLI





BOLLA

ELIO MARTINELLI



Lampada da soffitto a luce diffusa, per sorgenti di luce a LED. Diffusore in metacrilato opal bianco. Supporti in alluminio anodizzato girevoli per il fissaggio del diffusore senza bisogno di cacciavite. Completa di alimentatore elettronico all'interno del corpo lampada. Disponibile in tre dimensioni.

Ceiling lamp diffused light, for LED light source. White opal methacrylate diffuser. Swivel supports in anodized aluminium to fix the diffuser without a screwdriver. Electronic driver included inside the body lamp. Available in three sizes.

15,5W E27 LED 1520lm 3000K

2760/60/1 bianco / white

2760/50/1 bianco / white

2760/35/1 bianco / white

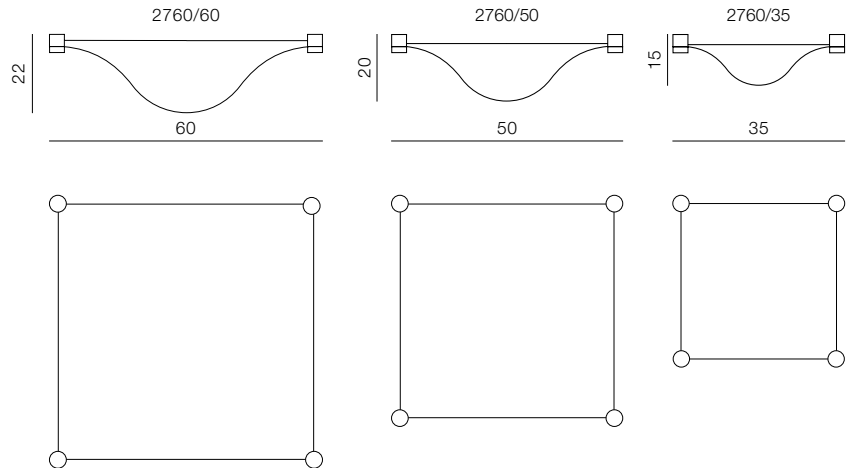



Data la particolarità della loro realizzazione, le lampade delle serie “Edizioni Speciali” e “Highlight”, i tempi di consegna verranno comunicati dall’azienda al momento dell’ordine.

Given the particularity of the production process of the lamps belonging to the series “Special Editions” and “Highlights”, their delivery date will be notified by the company upon order processing.



EDIZIONI SPECIALI SPECIAL EDITIONS

Le Edizioni Speciali comprendono alcune particolari versioni di lampade che hanno contribuito a fare la storia del design, realizzate nella ricorrenza dei loro 50 anni: il Pipistrello disegnato da Gae Aulenti nel 1965, presentato nella finitura oro, il Cobra disegnato da Elio Martinelli nel 1968, proposto nella versione Scorpis (un omaggio della figlia Emiliana al padre Elio nato nel segno zodiacale dello Scorpione). Nel 2018 Cobra viene proposta anche nella versione texture. Sono state inserite altre lampade più recenti come Cyborg, Civetta e Pistillo realizzate con diverse texture in occasione di esposizioni ed eventi.

The Special Editions includes some particular versions of lamps that have contributed to build the design history, made on the occasion of the 50th anniversary: the Pipistrello designed by Gae Aulenti in 1965, presented in the gold finish, the Cobra designed by Elio Martinelli in 1968, proposed in the Scorpis version (a tribute by his daughter Emiliana to her father Elio born in the zodiac sign of Scorpio). In 2018 Cobra is also proposed in a textured version. More recent lamps such as Cyborg, Civetta and Pistillo made with different textures have been included for exhibitions and events.





COBRA
SCORPIUS

COBRA SCORPIUS

Un Cobra stellare! La costellazione dello scorpione attraversata dalla via lattea.

La costellazione dello scorpione è una delle più brillanti e bella da osservare. Maestosa e insieme temibile, convivono in essa due istinti forti:

una grande energia e una capacità magica di leggere l'animo umano. Maestro incontrastato del misterioso mondo degli istinti. Tenace e perseverante, direi cocciuto. Coraggioso che vive il rischio come stimolo. Con grande capacità intuitiva ed osservativa. Razionale e lungimirante.

Curioso, amante della competizione e di avere un valido avversario per rendere il gioco più impegnativo e quindi più divertente. Direi che lo scorpione è proprio il segno di mio padre ed è con questo Scorpius che lo voglio ricordare.

A cosmic Cobra! Scorpio crossed by the Milky Way.

Scorpio is one of the brightest and most beautiful constellations to observe. Majestic and yet fearsome, it embodies two strong instincts:

a great energy and a magical ability to read into the human spirit. Undisputed master of the mysterious world of instincts. Tenacious and persevering, stubborn I'd say. Brave, experiencing risk as an incentive. With a great intuitive ability and a capacity for observation. Rational and farsighted.

Curious, lover of competition and of a worthy opponent to make the game more challenging and hence more fun.

I would say that scorpio is really the sign of my father and it's with this Scorpius that I want to remember him.

EMILIANA MARTINELLI, 2018



COBRA SCORPIUS



Il 50° anniversario di una lampada così importante per la Martinelli Luce come il Cobra disegnato dal suo fondatore Elio Martinelli rappresenta certamente un evento importante per l'azienda. In questa occasione viene proposta una speciale versione del Cobra, un'interpretazione di Emiliana come omaggio a suo padre. La lampada, prodotta solo in un esclusivo colore blu notte, è caratterizzata da una serie di fori sulla calotta, a rappresentare la costellazione dello Scorpione, il segno zodiacale di Elio.

ELIO MARTINELLI, 1968
EMILIANA MARTINELLI, 2018

The 50-year anniversary of such an important lamp for Martinelli Luce as the Cobra designed by its founder Elio Martinelli certainly represents an important event for the company.

For the occasion, a special version of the Cobra is produced, an interpretation by Emiliana as a tribute to her father.

The lamp comes in the exclusive night-blue color and is characterized by a series of holes on the cap representing the constellation of Scorpius, Elio's zodiac sign.





Evento Crepax, Showroom Martinelli Luce, Lucca



CIVETTA
VALENTINA

VISITA IL N

GUIDO
CREA

GUIDO
CREA

GUIDO
CREA

GUIDO
CREA

CIVETTA VALENTINA



Un omaggio a Valentina, il personaggio di Guido Crepax, sulla lampada Civetta di Emiliana Martinelli, un richiamo al mondo del fumetto.

Una texture in nero, con il volto di Valentina e la firma di Crepax, avvolge la superficie bianca della lampada.

Il progetto nasce dalla collaborazione con ©Archivio Crepax & Guido Crepax.

Struttura in alluminio verniciato, disco diffusore superiore in metacrilato bianco satinato.

Per lampadina LED.

A tribute to Valentina, Guido Crepax's character, on the Civetta lamp by Emiliana Martinelli, a reference to the world of comics.

A black texture with Valentina's face and Crepax's signature envelops the white surface of the lamp.

The project is a collaboration with ©Archivio Crepax & Guido Crepax.

Painted aluminium structure, satin white methacrylate upper diffuser disc.

For LED bulb.



Guido Crea
Valentina
REMAX MUSICALIGHT
Via S. Lucia, 9 - Lucca



GUIDO CREA
Valentina Musica
30.10 | 19
Spazio Musica





PISTILLO
PIOPPO
LUMINOSO

PISTILLO - PIOPPO LUMINOSO



L'architetto e artista Mauro Lovi è intervenuto sulla superficie della lampada Pistillo di Emiliana Martinelli con una texture nata dalla sua indagine artistica sui pioppi e le pioppete attraverso varie tecniche che sperimenta nei suoi quadri, disegni e acquarelli. È così nato il Pioppo luminoso, dove i segni delle pennellate cercano le cromie dei giochi di infanzia nelle pioppete nella memoria dell'autore. Lampada da terra a luce diffusa, struttura in metacrilato bianco. Base in metallo verniciato. Completo di alimentatore elettronico. Con variatore di luce.

Architect and artist Mauro Lovi has worked on the surface of Emiliana Martinelli's Pistillo lamp with a texture resulting from his artistic investigation of poplars and poplar groves using various techniques that he has been experimenting with in his paintings, drawings and watercolours. This is how Pioppo luminoso (Light Poplar) was born, where the brushstrokes seek out the colours of childhood games in poplar groves in the author's memory. Floor lamp providing diffused light, white methacrylate structure. Painted metal base. Complete with electronic driver. With light dimmer.

DESIGN EMILIANA MARTINELLI, 2003
TEXTURE MAURO LOVI, 2021

2260/P/L/1/BI/TEX/LO
H 195 60W LED 4700lm 3000K







HIGHLIGHT

La Serie HighLight raccoglie lampade la cui realizzazione richiede un particolare lavoro di finitura, svolto prevalentemente a mano, che le rende esclusive. Questa serie comprende Ruspa disegnata da Gae Aulenti nel 1968, sia nella versione a braccio singolo che in quella a quattro bracci; Profiterolle e Visiere disegnate da Sergio Asti nel 1968; le lampade Marx e V.D.L. disegnate da Richard Neutra nel periodo 1928 e 1931; la lampada Elos di Marcello Morandini e Cellule di Donia Maaoui.

The High Light Series includes lamps produced with a particular finish process, made mostly by hand. They are therefore exclusive products. This series includes the Ruspa lamp designed by Gae Aulenti in 1968, proposed in the single-arm and 4-arms version, Profiterolle and Visiere designed by Sergio Asti in 1968, Marx and V.D.L. lamps designed by Richard Neutra in the period 1928 and 1931, Elos lamp by Marcello Morandini and Cellule by Donia Maaoui.



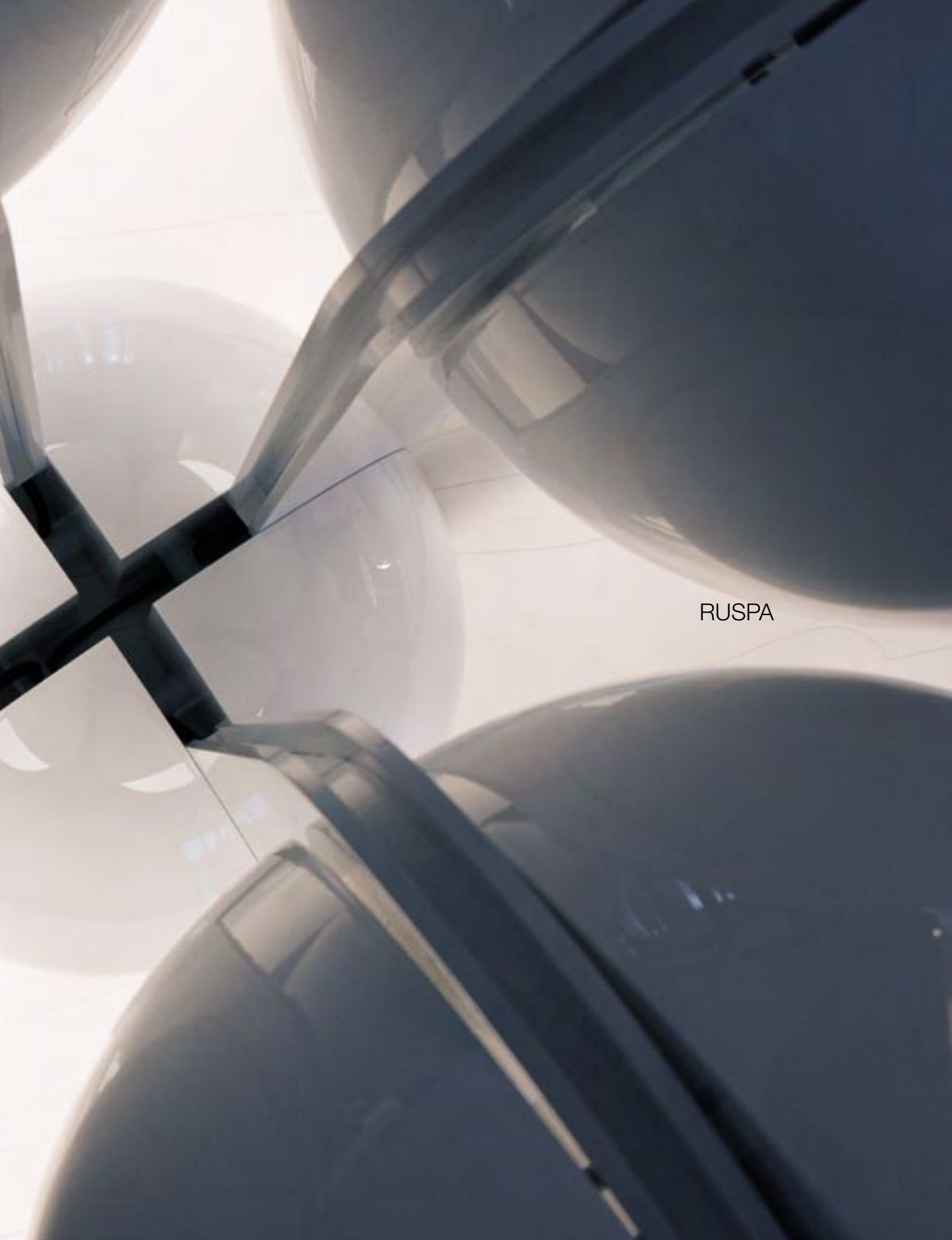

RUSPA



HANIMAGES©1988



Courtesy: By Hans Vosse





In occasione dei 10 anni dalla scomparsa dell'architetto Gae Aulenti, Martinelli Luce ha voluto ricordarla con un omaggio, la lampada Ruspa, che lei tanto amava, verniciata nel nuovo colore Giallo. Una speciale edizione firmata e numerata di questa lampada-scultura, presentata sia nella versione singola, sia in quella a 4 bracci.

On the occasion of the 10th anniversary of the death of the architect Gae Aulenti, Martinelli Luce wanted to remember her with a tribute, the Ruspa lamp, which she loved so much, painted in the new yellow colour. A special signed and numbered edition of this lamp-sculpture, presented both in the single version and in the 4-arm version.

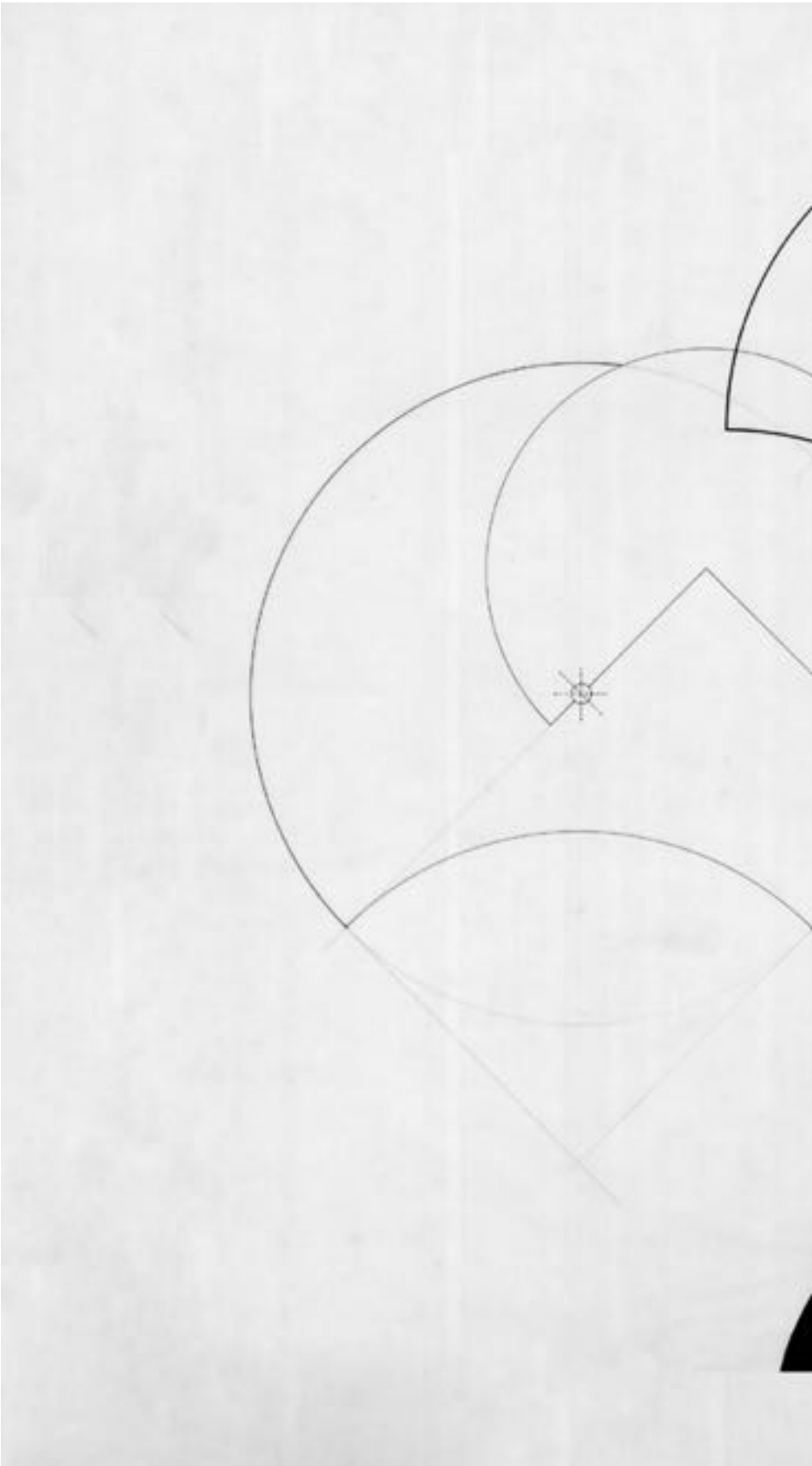



DOTT.
ARCH.
GAE
AULENTI

1967 LAMPADA
L1

RUSPA



Lampada da tavolo a luce diretta e indiretta, in alluminio verniciato nel colore bianco o nella versione firmata e numerata nel colore giallo. Braccio articolato sulla base e rotazione indipendente dei due riflettori sulla sua estremità. Disponibile anche nella versione con quattro bracci e otto riflettori. Per lampadine a LED.

Table lamp direct and indirect light, in white painted aluminium or in the signed and numbered version in yellow. The arm is jointed on the base, two reflectors turn around the upper part of the arm each one independently from the other. Available with four arms and eight adjustable reflectors version. For LED bulbs.

GAE AULENTI, 1968



RUSPA/4



Lampada da tavolo a luce diretta e indiretta, interamente in alluminio verniciato nel colore bianco o nella versione firmata e numerata nel colore giallo, formata da quattro bracci fissati sulla base, e da otto riflettori orientabili con rotazione indipendente uno dall'altro. Per lampadine a LED. Disponibile anche nella versione a un solo braccio.

Table lamp, direct and indirect light, in white painted aluminium or in the signed and numbered version in yellow, composed by four arms fixed on the base and by eight adjustable reflectors with and independent rotation of each one.

For LED light bulbs.
Also available with only one arm.

GAE AULENTI, 1968







PROFITEROLLE

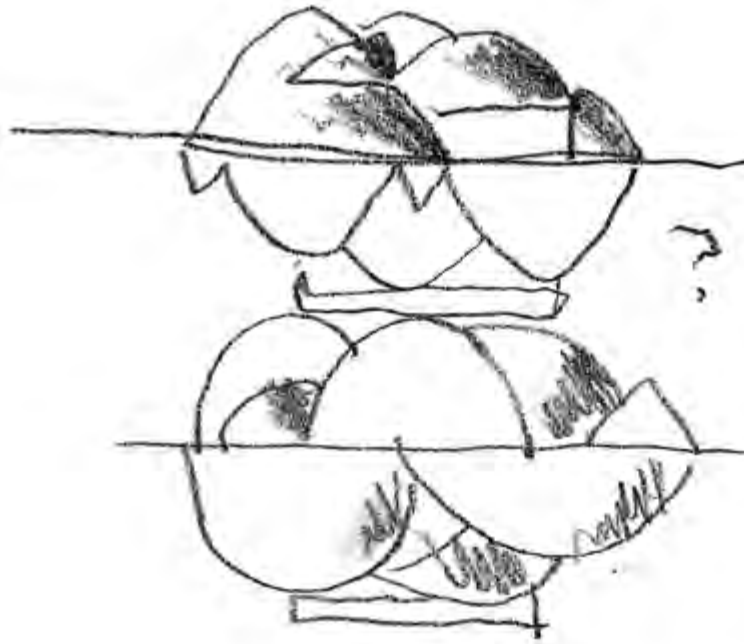

55





PROFITEROLLE



Lampada da tavolo o da terra a luce diffusa. Diffusore in metacrilato trasparente e poliestere con fibra di vetro, colore bianco ghiaccio, anello di congiunzione in gomma nera. Base in metallo laccato nel colore nero con targhetta firmata. Per Lampadine a LED.

Table or floor lamp with diffused light. Diffuser made of transparent methacrylate and polyester resin with fibre-glass crystal colour, connecting ring in black rubber. Black painted aluminium base with signed plate. For LED bulbs.

SERGIO ASTI, 1968







VISIERE

Sono passati tanti anni da quel 24 giugno del 1968, quando l'architetto Sergio Asti propose a mio padre Elio la lampada Visiere. Avevamo conosciuto il carissimo Sergio tramite un amico, il proprietario di Poltronova, un grande imprenditore amante del design e dell'innovazione, scopritore di giovani designer, colui che ci aveva presentato qualche anno prima l'architetto Gae Aulenti. Anche io ero là quel giorno quando Sergio ci illustrò la sua proposta, ero partecipe già in quel momento delle decisioni aziendali, in particolare per la scelta dei progetti da mettere in produzione. Asti inviò poi il disegno esecutivo della lampada, preciso e definito come una volta si era soliti fare, con le indicazioni dei materiali, colore, tipo di sorgente luminosa che vediamo nelle pagine successive. L'apparecchio era stato progettato inizialmente per l'utilizzo delle circline fluorescenti, segno della già sentita esigenza della necessità di un miglior uso dell'energia. Cominciammo a realizzare gli stampi per fare le mezze sfere, quello della base più difficoltoso essendo uno stampo diverso, scomponibile, data la necessità di produrre un componente che si estendeva per tre quarti di una sfera.

Inizì così il rapporto con Sergio e si instaurò un'amicizia reciproca e di lavoro in quanto seguirono altre lampade come il Profiterolle, caratterizzato dal diffusore realizzato in vetroresina, un esperimento tecnologico per quel periodo, come piaceva a lui e anche a noi, ed altre negli anni successivi.

Un rapporto amichevole e uno scambio di idee sul design che è durato fino alla sua scomparsa nel 2021.

Voglio ricordare Sergio Asti con questa lampada Visiere, uscita dal catalogo per diversi anni, ma che ritorna in produzione come gli avevo promesso in occasione di uno degli ultimi incontri nel suo studio a Milano. Lui ci teneva tantissimo e lo faremo felice quando vedrà che la sua creazione è tornata a illuminare i nostri spazi quotidiani.

Many years have passed since 24th June 1968, when the architect Sergio Asti proposed the Visiere lamp to my father Elio. We had met Sergio through a friend, the owner of Poltronova, a great entrepreneur who loved design and innovation, who discovered young designers, and who had introduced us to the architect Gae Aulenti a few years earlier.

I was there that day when Sergio presented us with his proposal, I was already part of the company's decision-making process, especially when it came to choosing which projects to put into production.

Asti then sent the executive drawing of the lamp, precise and defined as it used to be, with indications of the materials, colour, type of light source that we can see in the following pages. The fixture was initially designed to use fluorescent circles, a sign of the already widely need for a better use of energy.

We started to make the moulds for the half spheres. The one for the base was more difficult to make because it was different, it was decomposable, and it had a component that extended three quarters of a sphere.

This was the beginning of our partnership with Sergio, a mutual friendship and working relationship was established, as other lamps followed, such as the Profiterolle, with its fibreglass diffuser - a technological experiment at the time, as he and we liked it - and others in later years. A friendly relationship and an exchange of ideas on design that lasted until his death in 2021.

I would like to remember Sergio Asti with this Visiere lamp, which has been out of the catalogue for several years, but is back in production as I promised him during one of our last meetings in his studio in Milan. He was very attached to it and we will make him happy when he will find out that his creation has returned to illuminate our everyday spaces.

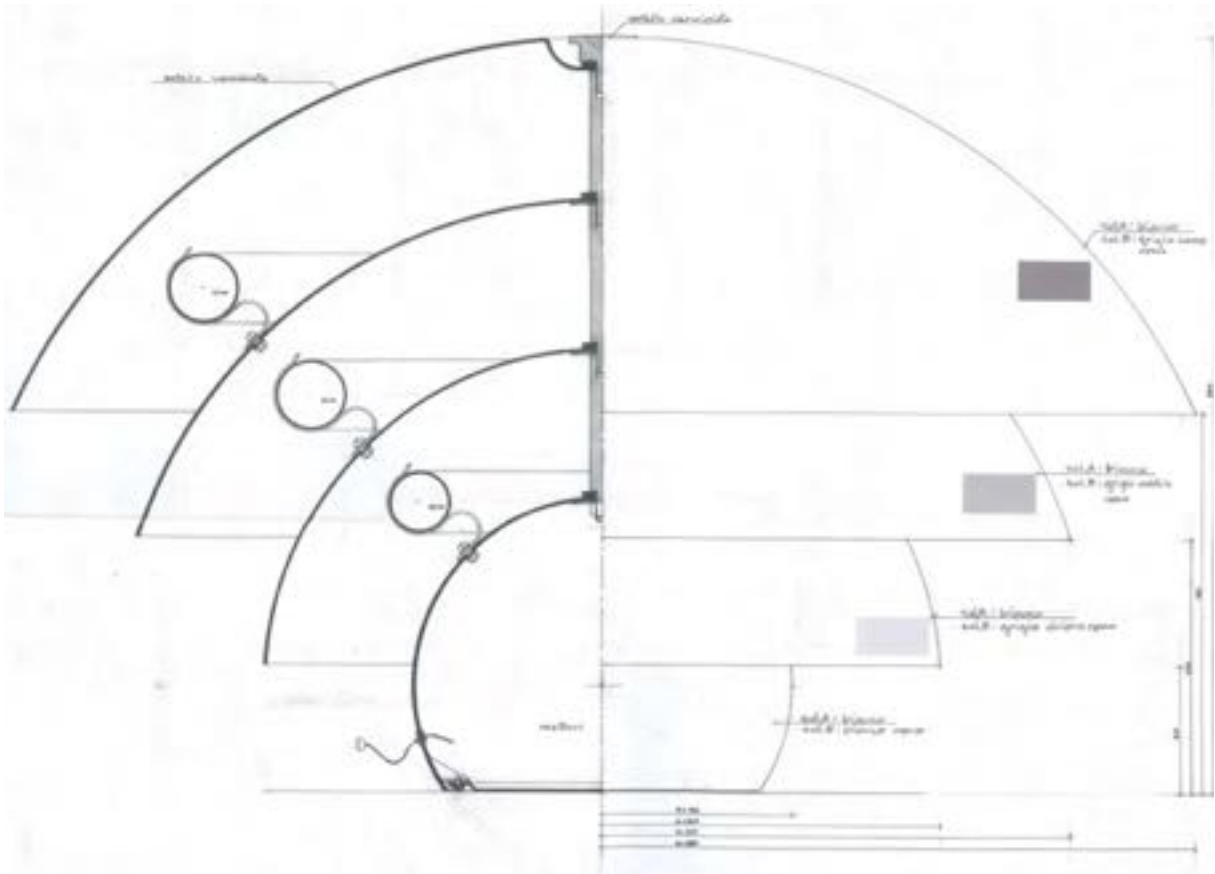



VISIERE



Per ricordare Sergio Asti torna in produzione, dopo tanti anni fuori catalogo, la lampada Visiere. Inizialmente progettata per circoline fluorescenti, segno della già sentita esigenza di un miglior uso dell'energia, è oggi riproposta per lampadine a LED.

Una luce morbida e soffusa si spande con toni diversi dai vari livelli delle tre semisfere sovrapposte in un gioco di luce e ombre. La lampada, a luce indiretta, creando un particolare effetto nell'ambiente, induce al relax ed alla riflessione.

Gli elementi in alluminio verniciati nel colore bianco sono fissati al perno centrale di sostegno tramite un piccolo pomello.

Base emisferica cablata per lampadine a LED.

In memory of Sergio Asti, the Visiere lamp is back in production after being out of print for many years. Initially designed for fluorescent circulators, a sign of the already felt need for a better use of energy, it is now reproposed for LED bulbs.

A soft, suffused light spreads in different tones from the different levels of the three overlapping hemispheres in a play of light and shadow. The indirect lamp creates a special effect in the room, inducing relaxation and reflection.

The white painted aluminium elements are fixed to the central support pin by means of a little knob.

Semi-spherical base wired for LED bulbs.

SERGIO ASTI, 1968

642/BI Ø 56 H 36 4x15W E27 LED









ELOS

Ritorna in catalogo dopo diversi anni la lampada Elos disegnata da Marcello Morandini. Ho conosciuto Marcello tanti anni fa, fu un incontro piacevolissimo, in casa in campagna con i miei genitori, a pranzo, sotto una grande tenda e pioveva, ...ci mettemmo a ridere. Si parlò di molte cose interessanti inerenti al design e del desiderio di avere un suo progetto nella nostra produzione. Disse: ci penso. Dopo un po' arrivò questa idea particolare che, direi, rivela bene il suo concetto dello spazio e della forma. Degli elementi geometrici semplici: un quadrato, un cerchio e una mezza sfera che grazie alla riflessione nello specchio su cui poggia viene percepita come la sfera, una "mutazione della forma nello spazio" come solo lui è riuscito ad elaborare nella sua continua ricerca.

The Elos lamp designed by Marcello Morandini is back in the catalogue after several years. I met Marcello many years ago. It was a very pleasant meeting, in the country house with my parents, at lunch, under a big tent and it was raining, ...we started laughing. We talked about many interesting things related to design and the desire to have one of his projects in our production. He said: I'll think about it. After a while, we came up with this particular idea which, in my opinion, reveals his concept of space and form very well. Simple geometric elements: a square, a circle and a half sphere which, thanks to the reflection in the mirror on which it rests, is perceived as the sphere, a "mutation of form in space" as only he was able to develop in his continuous research.

ELOS



Lampada da parete a luce diffusa.
Formata da uno specchio quadrato e da un diffusore a semisfera al centro che riflettendosi diventa una sfera.
Per sorgente di luce a LED integrata.
Completa di alimentatore elettronico dimmerabile.

Wall lamp with diffused light.
Formed by a square mirror and a hemisphere diffuser in the center which, when reflected, becomes a sphere.
Integrated LED light source.
Complete with dimmable electronic driver.

MARCELLO MORANDINI, 1987



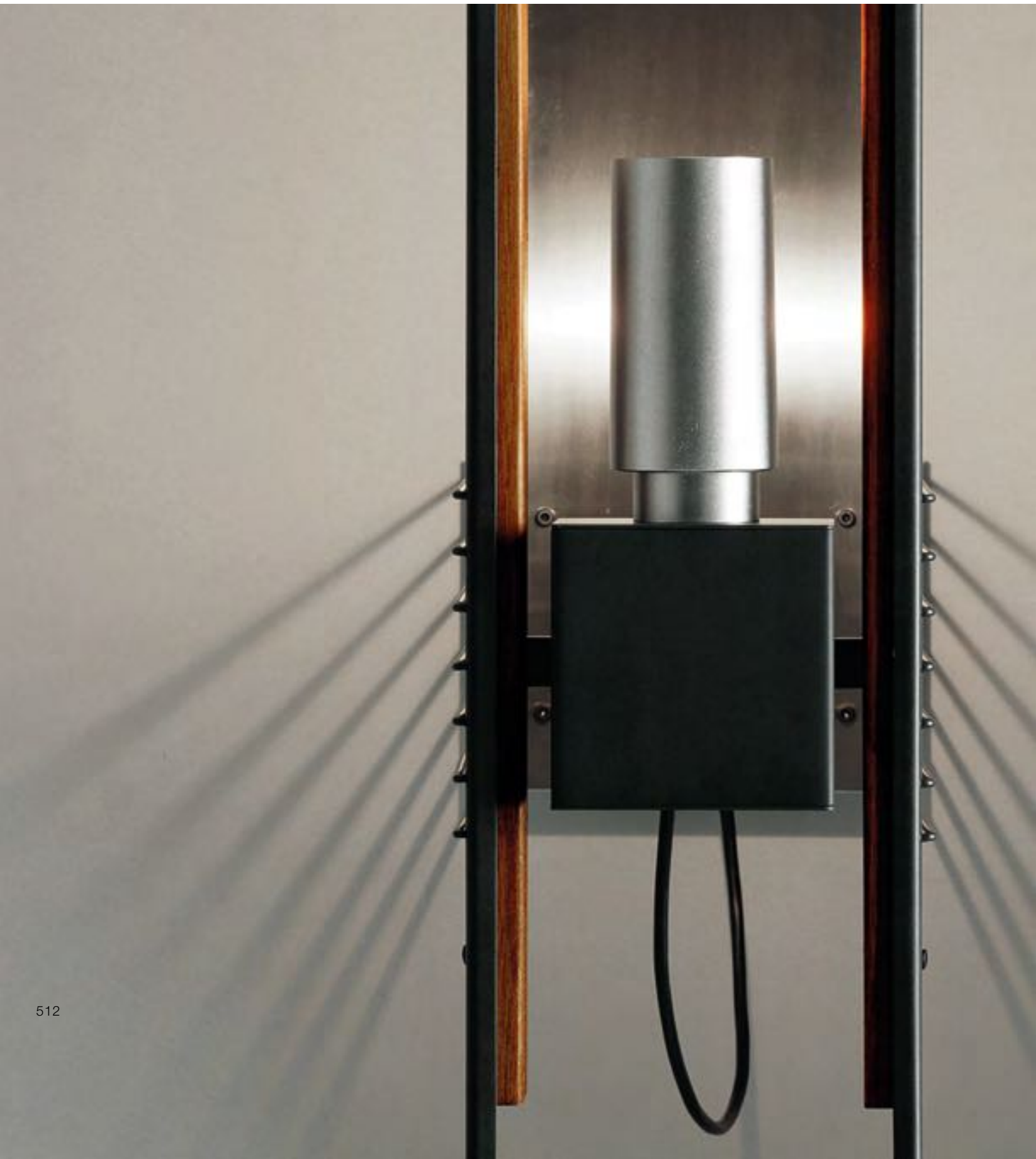

MARX

Una lampada progettata dall'architetto Richard Neutra per la casa del dottor Marx in California (credo) nel 1928.

Viene da noi prodotta ed è in catalogo già da diversi anni, da quando il figlio di Richard Dion, anche lui architetto, venne a trovarci a Lucca.

Ci parlò del padre, delle sue architetture nel Texas, con quei bellissimi specchi d'acqua che riflettendole ne amplificano i volumi e approvò sia il prototipo della lampada che avevamo preparato in base a degli schizzi di suo padre, sia la lampada da terra VDL, disegnata nel 1931.

A lamp designed by the architect Richard Neutra for Dr. Marx's house in California (I guess) in 1928. It has been produced by us and has been in our catalogue for several years, since Richard Dion's son, also an architect, came to visit us in Lucca. He told us about his father, about his architecture in Texas, with those beautiful mirrors of water that reflect and amplify the volumes, and he approved both the prototype of the lamp that we had prepared based on sketches by his father, and the VDL floor lamp, designed in 1931.



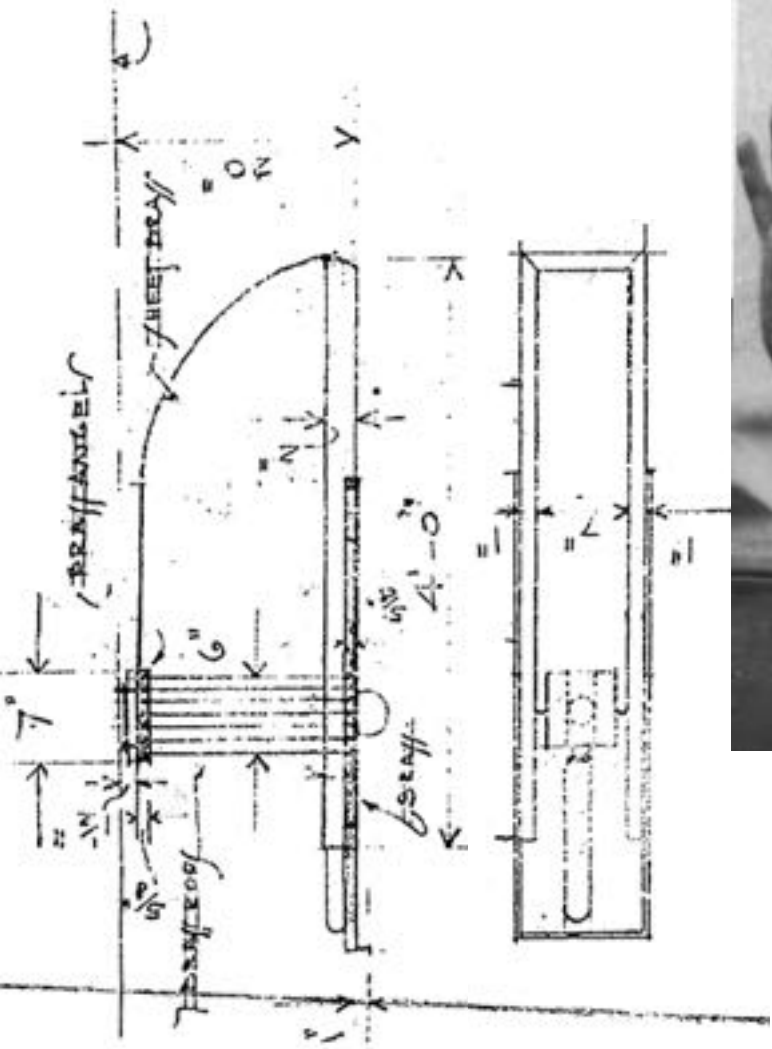

MARX



Lampada da parete a luce indiretta. Struttura in acciaio inox satinato, base e supporti in metallo verniciato nel colore antracite, telaio di supporto in legno. Per lampadina a LED.

Wall lamp indirect light. In satin stainless steel structure, anthracite painted metal base and supports, wooden frame. For LED bulb.

RICHARD NEUTRA, 1928







V.D.L.



V.D.L



Lampada da terra a luce indiretta.
Struttura composta da base, stelo
e riflettore in acciaio inox satinato.
Con regolatore di intensità
luminosa sul cavo.
Per sorgente di luce a LED.

Floor lamp indirect light.
Satin stainless steel structure
composed of base, stem, reflector.
With light intensity regulator on the
cable.
For LED light source.

RICHARD NEUTRA, 1931







CELLULE

Una lampada che fa trapelare le origini di Donia, nata in Tunisia. Architetto e scultrice. Una carissima amica con la quale ci vediamo spesso per parlare di design, tra i suoi buonissimi couscous e la musica, con gli amici e con suo marito Michel. Un giorno le ho proposto di disegnare una lampada per noi.

Così è nata Cellule, una trama di elementi irregolari non figurativi, come nella tradizione islamica, che ricordano i mashrabiyya, ma anche il riprodursi della "cellula primordiale" che sta alla base della vita. I pannelli possono essere disposti singoli o vicino uno all'altro così da formare un movimento e un giuoco di luce e ombre.

A lamp that reveals the origins of Donia, an architect and sculptor born in Tunisia.

She is a very close friend with whom we often meet to talk about design, with her delicious couscous and music, with friends and with her husband Michel. One day I suggested that she might design a lamp for us.

And so Cellule was born, a weave of irregular, non-figurative elements, as in the Islamic tradition, reminiscent of the mashrabiyya, but also of the reproduction of the "primordial cell" that is the basis of life. The panels can be arranged individually or close to each other to form a movement and play of light and shadow.

CELLULE



Lampada da parete a luce indiretta. Un gioco di luce e ombra. Struttura in metallo tagliato a laser verniciato nel colore bianco o dorata su richiesta. Per sorgente di luce a LED, alimentatore elettronico integrato nel corpo della lampada.

Wall lamp, indirect light, a play of light and shadows. White painted aluminium structure lasert cut or golden color on request. For LED light source. Electronic driver integrated into the body lamp.

DONIA MAAOUI, 2015

1427	60x60	20 W LED
	500lm	3000K
1427/AU	60x60	20 W LED
	1500lm	3000K
1427/G	60x60	60W LED
	4500lm	3000K
1427/G/AU	60x60	60W LED
	4500lm	3000K







COMPLEMENTI DI ARREDO
FURNISHING ACCESSORIES



METAFORA



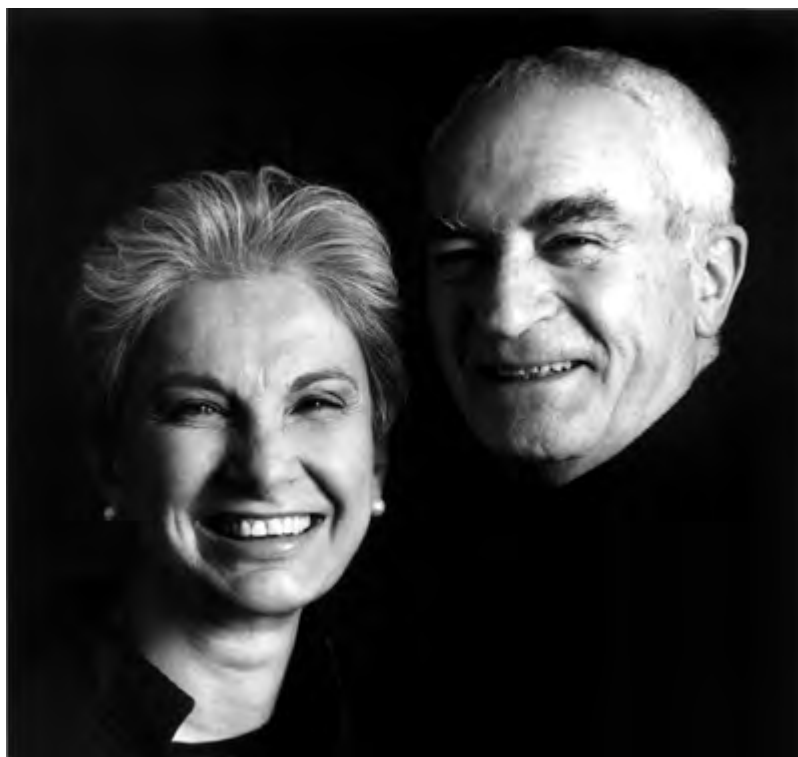

Questo tavolo esprime il nostro concetto di identità e diversità.
This table expresses our concept of identity and diversity.

LELLA E MASSIMO VIGNELLI

METAFORA

Metafora, un piano... pieno di significato. Dalla sua prima presentazione, al salone del mobile del 1979, il tavolo Metafora, disegnato da Lella e Massimo Vignelli, ha affascinato per l'estetica, la scelta delle forme e dei materiali, dove nessun particolare è casuale ma tutto legato da un fil rouge di significati e riferimenti storici. La sfera rappresenta il globo terrestre, il nostro pianeta, origine e sostentamento dell'umanità. La piramide rappresenta la civiltà egizia, il primo grande esempio di organizzazione sociale, culla di cultura e spiritualità. Il cilindro in travertino ripropone l'impero romano, apice di un mondo antico poi rovinosamente crollato, ecco perché la colonna è rovesciata a terra. Il cubo nero rappresenta la pietra nera della Kaaba, a la Mecca, elemento fondante dell'Islam, un altro dei grandi pilastri dell'umanità. Tutti questi simboli e significati raccolti in un'unica ambientazione, fondendo così design a cultura e sensibilità per l'avventura umana.

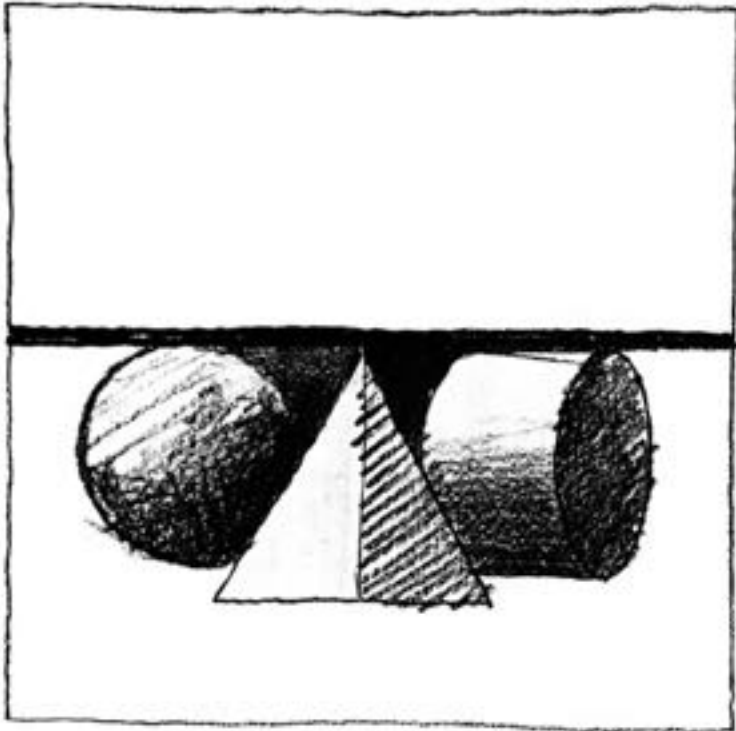

Metafora, a table top... full of meaning. Since its first presentation at the 1979 Salone del Mobile, the Metafora table, designed by Lella and Massimo Vignelli, has fascinated for its aesthetics, the choice of shapes and materials, where no detail is random but everything is linked by a fil rouge of meanings and historical references. The sphere represents the globe, our planet, the origin and sustenance of humanity. The pyramid represents Egyptian civilisation, the first great example of social organisation, the cradle of culture and spirituality. The travertine cylinder represents the Roman Empire, the pinnacle of an ancient world that later collapsed, which is why the column is upside down on the ground. The black cube represents the black stone of the Kaaba in Mecca, the founding element of Islam, another of the great pillars of humanity. All these symbols and meanings collected in one setting, thus fusing design with culture and sensitivity for the human adventure.

METAFORA

LELLA E MASSIMO VIGNELLI, 1979

Le quattro forme della geometria Euclidea, Cubo, Cilindro, Sfera e Piramide, in quattro marmi diversi, formano la base del tavolo completato da una grande lastra di vetro trasparente. I quattro elementi sono indipendenti e possono essere posizionati liberamente, senza che il tavolo perda la propria identità indifferentemente dalla posizione degli elementi che lo compongono, tutti comunque necessari a dargli stabilità.

The four shapes of Euclidean geometry, Cube, Cylinder, Sphere and Pyramid, in four different marbles, form the base of the table completed by a large sheet of transparent glass. The four elements are independent and can be positioned freely, without the table losing its identity, regardless of the position of the elements that make it up, all of which are necessary to give it stability.

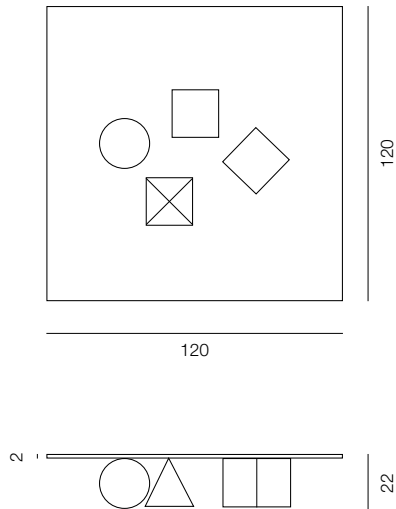

1979.1

Piramide in Marmo bianco di Carrara, Cubo in nero Marquinia, Cilindro in Travertino Sfera in Emperador dark.

The Pyramid in Carrara white marble, The Cube in black Marquinia marble, The Cylinder in Travertine, The Sphere in Emperador dark.

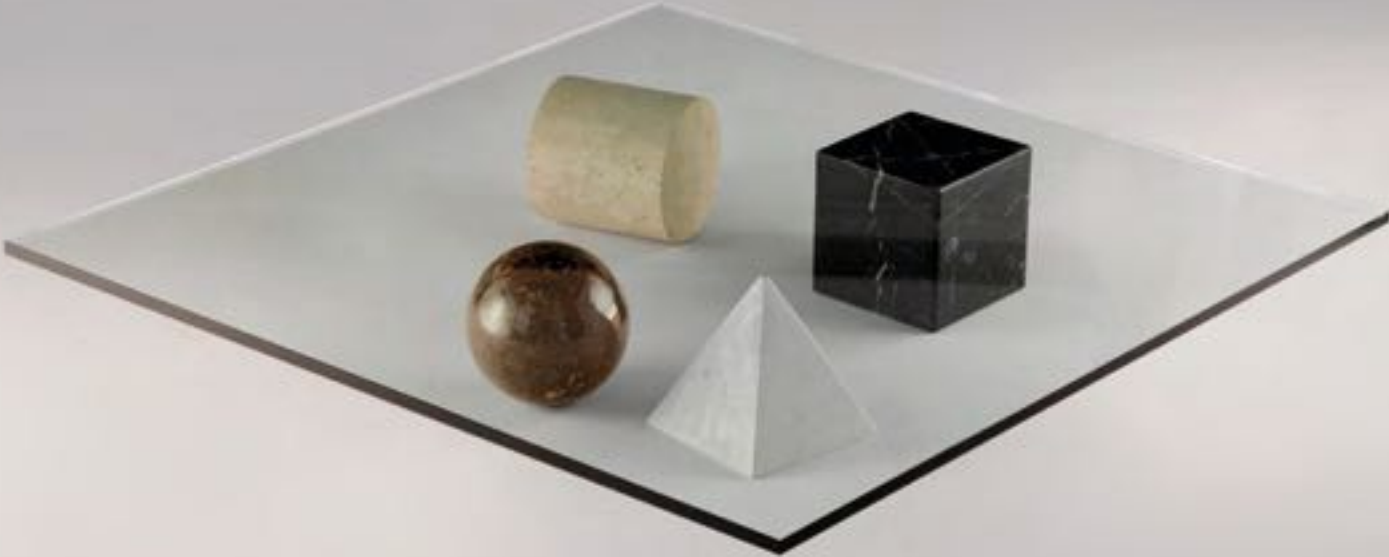

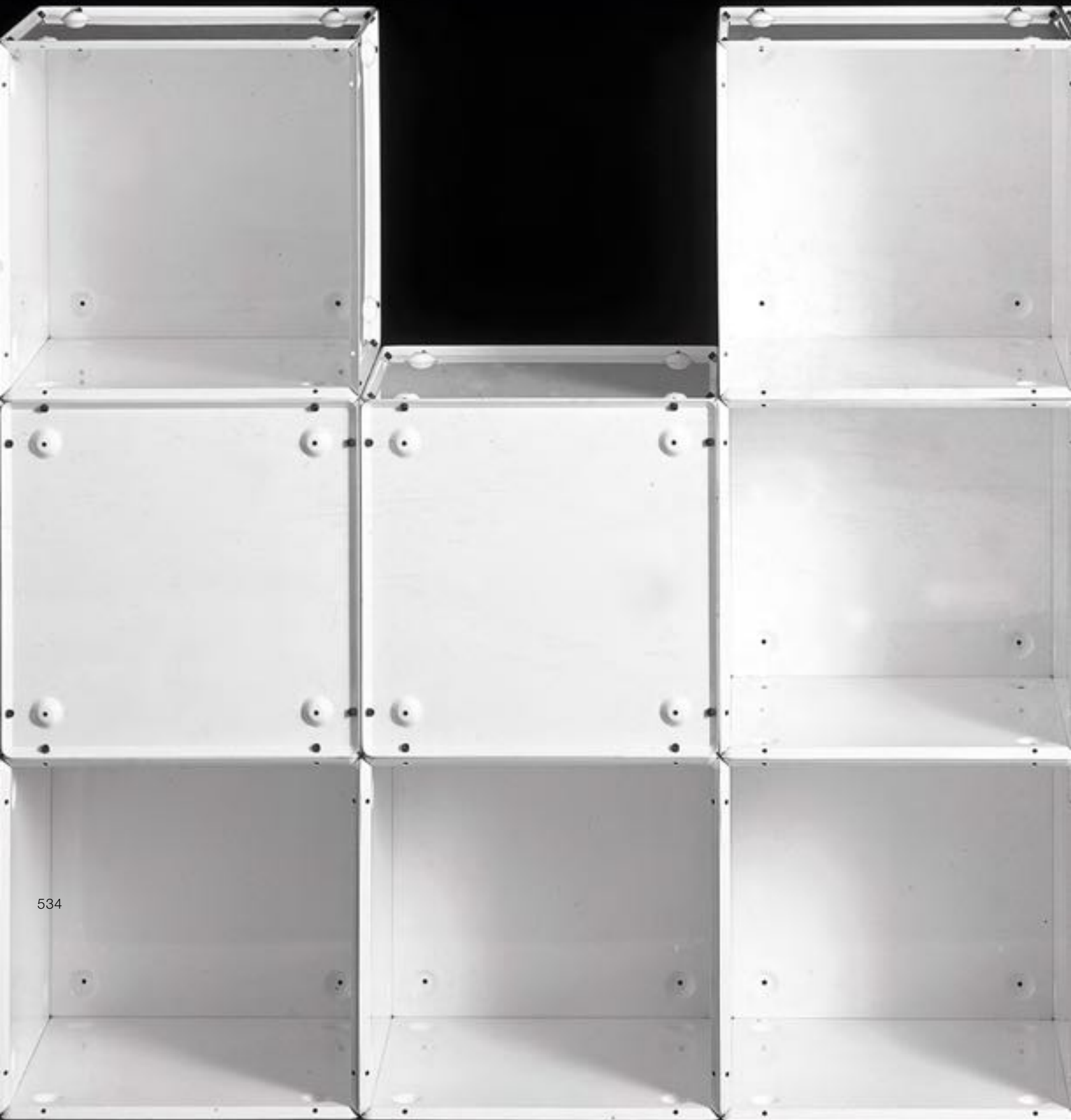

BOX

Box è un contenitore componibile, progettato nel 1974, che nasce dalla ripetizione di un unico elemento piano in acciaio stampato. Cinque elementi formano un Box: è il modulo base. Tanti Box formano... quasi tutto. Con Box puoi fare una libreria, un divisorio, un tavolo basso... quasi tutto. Box non ha bisogno di appoggi, è autosufficiente. Non ha necessità di vivere accanto a una parete, può stare in mezzo alla stanza, diventa torre, isola, muro. E all'occorrenza Box diventa piccolo piccolo: sette metri quadrati di scaffalatura occupano smontati... quasi nulla: il volume di un Box.

Box is a modular container created by the repetition of a single flat element in pressed steel. Five elements form a Box: this is the basic module. Many boxes make up... almost everything. With Box you can make a bookcase, a divider, a low table... almost anything. Box does not need support, it is self-sufficient. It doesn't need to live next to a wall, it can stay in the middle of the room, it becomes a tower, an island, a wall. And if necessary Box becomes small: when disassembled they take up seven square metres of shelving... almost nothing: the volume of a Box.

ELIO MARTINELLI, 1974

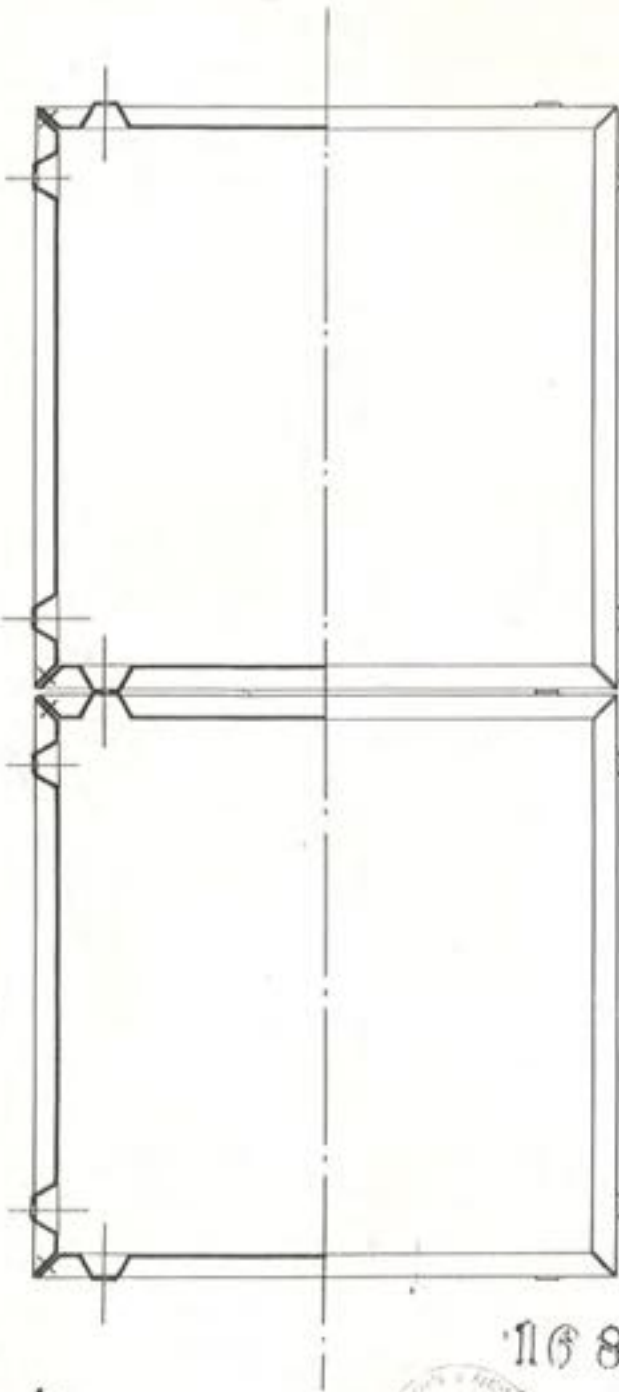

7

M. G. G.



168882

L'UFFICIALE ROGA

Alberto...





BOX

ELIO MARTINELLI

Contenitore componibile in metallo costruito con l'impiego di un unico pannello assemblato con viti.

Cinque pannelli formano un cubo di 37x37x37 - BOX/37.

Altri colori RAL su richiesta per quantità da concordare.

Modular metal container built using a single panel assembled with screws.

Five panels form a cube of 37x37x37 - BOX/37.

Other RAL colours on request for quantities to be agreed upon.

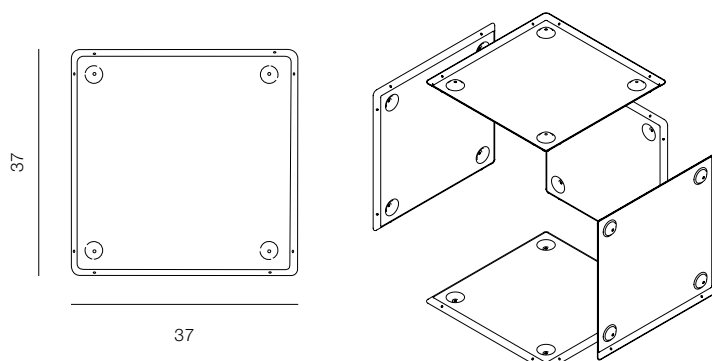

BOX/37

A giorno da montare.
Confezione minima di 2 Box 37x37x37.

Open unit box to be assembled.
Package minimum of 2 Boxes 37x37x37.

5 pannelli 37x37 / 5 panels 37x37

BOX/37/BI ○ bianco / white

BOX/37/NE ● nero / black

BOX/37/GR ● grigio / grey



BOX/37/S

Chiuso, con anta e serratura, montato.
Confezione da 1 Box 37x37x37.

Closed, with hinged door and lock, already assembled. Package of 1 Box 37x37x37.

7 pannelli 37x37 / 7 panels 37x37

BOX/37/S/BI ○ bianco / white

BOX/37/S/NE ● nero / black

BOX/37/S/GR ● grigio / grey

538



Kit di 4 ruote per box
Kit of 4 wheels per box

30080 ● nero / black

Base e top in legno verniciato su richiesta
Painted wooden base and top on request





INDEX

INDICE PER CODICE / CODE INDEX

510X	304	685/AU	130	832/BI	52
511X	304	685/BI	130	832/CL/AZ	54
5278	224	685/BL	130	832/CL/BI	54
5278	226	685/GI	130	832/CL/GI	54
541Y	306	685/NE	130	832/CL/NE	54
542Y	306	685/RO	130	832/GI	52
599	176	685/VE	130	832/NE	52
599/AU	176	736/L/GR	126	833/BI	48
620/BI	146	736/L/NE	126	833/NE	48
620/DIM/BD/L/1/BI	150	736/L/VE	126	1196/BI	454
620/DIM/BD/L/1/MA	150	793/NE/BI	120	1221/BI	452
620/DIM/BD/L/1/OT	150	799/DIM/L/1/GR	116	1221/V/BI	452
620/DIM/BD/L/1/TI	150	799/L/1/BD/BI	114	1249/3/L/1	450
620/DIM/L/1/BI	148	799/L/BD/BI	114	1261/BI	452
620/DIM/L/1/MA	148	799/MED/DIM/L/1/GR	116	1261/V/BI	452
620/J/DIM/AU	162	804/BI/AR	106	1285	516
620/J/DIM/BI	162	804/BI/BI	106	1341/L/1/AU	444
620/J/DIM/CU	162	804/TEXTURE/VA	476	1341/L/1/BI	444
620/J/DIM/MA	162	807/J/BI	104	1341/L/1/CU	444
620/J/DIM/OT	162	807/J/GI	104	1341/L/1/NE	444
620/J/DIM/RO	162	807/J/NE	104	1342/L/1/AU	444
620/J/DIM/T/CL/BI	168	811/T/H/NE	98	1342/L/1/BI	444
620/J/DIM/T/CL/MA	168	812	338	1342/L/1/CU	444
620/J/DIM/T/CL/VE	168	817/BI	94	1342/L/1/NE	444
620/J/DIM/TI	162	820/BI	90	1343/L/1/AU	444
620/J/DIM/VE	162	820/BL	90	1343/L/1/BI	444
620/MA	146	820/GI	90	1343/L/1/CU	444
620/MED/DIM/BI	156	820/OT	90	1343/L/1/NE	444
620/MED/DIM/MA	156	823/BI	86	1347/Q	510
620/MED/DIM/OT	156	824/BI	80	1427	524
620/MED/DIM/TI	156	824/NE	80	1427/AU	524
620/MED/DIM/VE	156	825/AL	76	1427/G	524
620/NE	146	825/AZ	76	1427/G/AU	524
620/OT	146	825/BI	76	1431/230/BI	442
620/RO	146	825/FC	76	1431/230/GI	442
620/TI	146	825/GR	76	1431/230/MS	442
620/VE	146	825/VE	76	1434/2700/BI	426
629	138	828/CH	62	1434/DIM/2700/BI	426
629/NE	138	828/CP	62	1434/DIM/T/BI	426
629/RO	138	828/J/CH	62	1437/BI	430
629/SC	472	828/J/CP	62	1442/BI	390
633/4/BI	494	828/J/MAR/CA	64	1442/NE	390
633/4/GI	494	828/J/MAR/MR	64	1445/NE	418
633/BI	492	828/J/NE	62	1454/AU	408
633/GI	492	828/MAR/CA	64	1454/BI	408
640	500	828/MAR/MR	64	1454/CO	408
642/BI	506	828/NE	62	1454/J/AU	408
685/AR	130	832/AZ	52	1454/J/BI	408

INDICE PER CODICE / CODE INDEX

1454/J/CO	408	2096/DIM/2700/GI	250	2312/GI	330
1454/J/NE	408	2096/DIM/2700/NE	250	2312/NE	330
1454/NE	408	2096/DIM/BI	250	2314/BI	280
1455/BI	386	2096/DIM/GI	250	2314/NE	280
1455/GR	386	2096/DIM/NE	250	2316/AR	290
1455/NE	386	2096/G/DIM/2700/BI	250	2316/NE	290
1459/BI	380	2096/G/DIM/2700/GI	250	2316/VE	290
1722	274	2096/G/DIM/2700/NE	250	2317	286
1858	268	2096/G/DIM/BI	250	2319/AZ	296
1861/BI	266	2096/G/DIM/GI	250	2319/BI	296
1861/BL	266	2096/G/DIM/NE	250	2319/GI	296
1861/BL	266	2099/L/1/CO	240	2319/NE	296
1861/J/BI	266	2131/AU	374	2760/35/I	464
1861/NE	266	2131/BI	374	2760/50/I	464
1861/NE	266	2217/L/1/AU	368	2760/60/I	464
1861/RO	266	2217/L/1/BI	368	2764/22/BI	412
1861/RO	266	2217/L/1/NE	368	2764/32/BI	412
1889	264	2217/POL/P/BD/BT/L/1	364	2771/42/I	458
1889/AU	264	2217/POL/P/BD/L/1	364	2771/52/I	458
1979.1	532	2217/POL/P/BT/L	364	2834/M/J/L/1	434
2011J	262	2234/L/1	520	2834/M/L/1	434
2033/45/C/AR	260	2260/P/L/1/BI	356	2868/J/L/1	456
2033/45/C/BI	260	2260/P/L/1/BI/TEX/LO	480	2868/L/1	456
2033/45/C/BL	260	2270/BI	348	2880/30	436
2033/45/C/GI	260	2270/NE	348	2885/S/NE	218
2033/55/C/BI	260	2270/NE/NE	348	2891/DIM/2700/BI	420
2040/65/SD	256	2270/XG/NE/NE	350	2891/DIM/2700/GI	420
2040/J	256	2278/NE	332	2891/DIM/2700/NE	420
2040/SD	256	2287/DIM/L/1/BI	342	2891/DIM/BI	420
2073	230	2289/BI	326	2891/DIM/GI	420
2073/J	230	2289/NE	326	2891/DIM/NE	420
2093/50/AU	246	2290/AU	334	2899/AU	406
2093/50/BI	246	2290/NE	334	2899/BI	406
2093/50/CO	246	2301/AZ	314	2899/CO	406
2093/50/NE	246	2301/GI	314	2899/NE	406
2093/AU	246	2301/GR	314	2900/J/BI	410
2093/BI	246	2301/NE	314	2900/J/CO	410
2093/CO	246	2301/RO	314	2900/J/NE	410
2093/J/50/AU	246	2302/NE	320	2900/J/OT	410
2093/J/50/BI	246	2303/NE	322	2901/BI	400
2093/J/50/CO	246	2304/NE/MAR/MR	354	2901/GI	400
2093/J/50/NE	246	2309/AR	304	2901/J/BI	400
2093/J/AU	246	2309/BL	304	2901/J/GI	400
2093/J/BI	246	2309/GI	304	2901/J/RO	400
2093/J/CO	246	2309/J/AR	306	2901/J/VE	400
2093/J/NE	246	2309/J/BL	306	2901/RO	400
2093/NE	246	2309/J/GI	306	2901/VE	400
2096/DIM/2700/BI	250	2312/BI	330	2902/BI	396

INDICE PER CODICE / CODE INDEX

5049	224	40171/BI	192
5049	226	40172/AR	192
5056	224	40172/BI	192
5056	226	40172/BL	192
21002/AN	236	40172/GI	192
21004/BI	212	40173/AR	192
21004/DIM/CL/NE	68	40173/BI	192
21015/BI	206	40173/BL	192
21015/GI	206	40173/GI	192
21015/NE	206	40174/AR	192
21016/BI	196	40174/BI	192
21017/DIM/NE	202	40174/BL	192
21019/DIM/3000/AR	184	40174/GI	192
21019/DIM/3000/AZ	184	40183/NE/BI	394
21019/DIM/3000/BI	184	40183/NE/RO	394
21019/DIM/3000/NE	184	40184	394
21019/DIM/AR	184	40186	394
21019/DIM/AZ	184	40187/NE	394
21019/DIM/BI	184	40189/AZ	184
21019/DIM/NE	184	40189/GR	184
30080	538	BOX/37/BI	538
30837	230	BOX/37/GR	538
30857/AZ	224	BOX/37/NE	538
30857/BI	224	BOX/37/S/BI	538
30857/GI	224	BOX/37/S/GR	538
30857/RO	224	BOX/37/S/NE	538
30857/VE	224		
30859/BI	224		
30859/BI	226		
30860/BI	224		
30860/BI	226		
30861/BI	224		
30861/BI	226		
30862/BI	222		
30862/BI	226		
30863/AZ	226		
30863/BI	226		
30863/GI	226		
30863/RO	226		
30863/VE	226		
30864/BI	226		
30865/BI	226		
30867/BI	226		
30901/BI	226		
30903/BI	224		
30903/BI	226		
40065	54		
40065	68		

Benvenuto Saba: 40, 44, 46, 47, 48, 49, 50, 53, 55, 58, 59, 60, 63, 64, 65, 68, 69, 72, 74, 76, 77, 80, 81, 82, 84, 85, 88, 90, 91, 94, 96, 98, 102, 103, 104, 106, 107, 108, 110, 111, 112, 113, 114, 115, 116, 117, 120, 121, 122, 124, 125, 126, 128, 131, 136, 138, 139, 144, 148, 149, 152, 153, 157, 159, 163, 166, 167, 176, 177, 180, 182, 183, 188, 190, 191, 193, 194, 196, 197, 198, 200, 203, 204, 207, 210, 212, 213, 219, 227, 228, 231, 237, 251, 252, 254, 255, 258, 261, 263, 265, 267, 269, 270, 272, 273, 275, 278, 280, 281, 282, 288, 291, 292, 297, 298, 300, 302, 305, 307, 311, 315, 319, 321, 328, 327, 328, 330, 331, 332, 333, 335, 336, 337, 352, 354, 355, 357, 358, 360, 363, 369, 378, 380, 381, 384, 385, 386, 387, 388, 390, 391, 392, 395, 396, 398, 401, 402, 422, 424, 427, 428, 431, 432, 436, 465, 468, 472, 473, 476, 477, 478, 480, 481, 488, 492, 493, 494, 495, 496, 500, 502, 505, 506, 507, 508, 510, 511, 514, 516, 517, 518, 520, 521, 522, 528, 532, 533
(Assistenti: Simone Conti, Mirko Petrini. Post produzione: Francesco Bonuccelli)

Marco Cardelli: 56, 61, 75, 86, 87, 134, 135, 147, 151, 154, 155, 158, 160, 164, 169, 232, 248, 334, 342, 343, 344, 345, 347, 349, 362, 366, 372, 373, 374, 438, 442, 443, 445, 451, 453, 455, 499, 500, 524

Massimiliano Bolcioni: 99, 127, 130, 323, 351, 435

Aldo Ballo: 9

Ugo Mulas: 140

Hans Visser: 466

Luigi Rinaldelli: 217

Vincenzo Oliviero: 446, 448, 450

Emiliana Martinelli: 95, 175, 236, 303, 304, 312, 350, 484

Marco Ghilarducci: 161

Ilaria Costanzo: 375

Stefano Anzini: 222, 225

Roberto Favilla: 150, 474

Omar Sartor: 365

Area 17: 238, 240, 241

Studio Paola Navone: 66

Karim Rashid: 70

Adolini & Simonini: 78

Studio Orlandini: 92, 324

Brian Sironi: 100, 105

Marc Sadler: 119

Peluffo&Partners: 192

Pls Design - Lorenzo Perini: 242

Studio Habits: 308, 310

Simon Schmitz: 284, 287, 316

Michel Boucquillon: 340

Neil Poulton: 382

Venezia: 214

Michael Geldmacher: 208

Archivio Aulenti-Rolly Marchi: 141, 142

Archivio Martinelli Luce: 4, 132, 172, 174, 370, 534, 536, 537, 539

Studio BF: 211, 216, 234, 413, 421, 437, 441, 457

Marco Ghilarducci: 245, 247, 318, 407, 440, 460, 462, 463

Enrico Capanni: 313, 411, 525

Studio Lorenzo Perini: 244, 404, 405, 409

THANKS TO

Studio Ark, Lucca
Arredamenti Landucci, Seravezza
Showroom Dinelli & Rossi, Lucca
Lintea Mare, ViareggioMariani
arredamenti, Lucca
Mazzoni Studio d'Interni, San Miniato:
Showroom Giovannetti,
QuarrataShowroom Schifini, Lucca
De Padova
Technogym

LEGENDA / LEGEND



Con sorgente di luce a LED nella descrizione di ogni singolo apparecchio, significa che il LED è integrato e non sostituibile dal cliente.

With a source of LED light in the description of each device means that LED is integrated and it is not possible to replace it by customer.



Con lampadina LED nella descrizione di ogni singolo apparecchio significa che è predisposto per lampadina LED, che può essere sostituita ma non è inclusa.

With LED bulb in the description of each device means that it is preset to a LED bulb and it is possible to replace it, but it is not included.

Tutte le lampade sono fornite senza lampadina ad eccezione del mod.620 Pipistrello e delle lampade con LED integrato. Le dimensioni sono espresse in centimetri.

All lamps are supplied without light bulb, with exception for the model 620 Pipistrello and of lamps with LED integrated. The dimensions are expressed in centimeters

DIM Dimmerabile nel codice di ogni singolo apparecchio significa che è fornito di alimentatore con protocollo DALI e SWITCH DIM.

Dimmable in the code of each device means that it is equipped with a DALI and SWITCH DIM driver protocol.

I flussi luminosi (lumen) e la potenza indicata (Watt), evidenziati in ogni singolo apparecchio sono i valori nominali corrispondenti alla relativa sorgente di luce. I dati effettivi sono visibili all'interno delle nostre curve fotometriche in formato Eulumdat scaricabili dal nostro sito web nell'area download, oppure all'interno di ogni singola scheda prodotto.

The luminous fluxes (lumen) and the specified power (Watt), underlined in each device, are the nominal values corresponding to the relative source of light. The real data are visible in our photometric curves in a Eulumdat format, you can download from our web site in the download area, or in each product specifications.



Classe prima, ovvero apparecchio provvisto di isolamento fondamentale in ogni parte e con parti conduttrici accessibili collegate ad un conduttore supplementare di protezione (messa a terra).

Class 1: appliance fitted with basic insulation throughout and with accessible live parts conneted to a supplementary safety circuit (ground).



Classe seconda, ovvero apparecchio provvisto di doppio isolamento o isolamento rinforzato senza dispositivi per la messa a terra.

Class 2: appliance fitted with double insulation or reinforced insulation without ground connection.



Classe terza, ovvero apparecchio previsto per il funzionamento a bassissima tensione di sicurezza in cui non si producono tensioni superiori alla stessa.

Class 3: appliance deisgned for safety extra low voltage (S.E.L.V.) operation in which not higher voltages are produced.

GRADO DI PROTEZIONE IP IP PROTECTION DEGREE



Apparecchio protetto contro la penetrazione di corpi solidi di dimensioni maggiori a 12 mm e non protetto nei confronti dei liquidi.

Protected against the penetration of solid objects greater than 12 mm and non protected against liquids.



Apparecchio protetto contro la penetrazione di corpi solidi di dimensioni maggiori a 1 mm.

Protected against the penetration of solid objects greater than 1 mm.

MARCHI DI CERTIFICAZIONE MARKS OF APPROVAL



CSQ-IQNET - Marchio valido in tutto il mondo, certifica che l'azienda Martinelli Luce attua un sistema di gestione della Qualità conforme alla normativa UNI EN ISO 9001:2015, per garantire un elevato standard qualitativo nella progettazione, sviluppo, fabbricazione e commercializzazione dei propri prodotti.

The **CSQ-IQNET** label is valid all over the world. It certifies that Martinelli Luce runs a quality management system which complies with the UNI EN ISO 9001:2015 standard, to guarantee a high quality level for what concerns project, development, production and distribution of its products.



ENEC 03 - il marchio ENEC (Certificazione Elettrica relativa alle Norme Europee) è un marchio volontario rilasciato da enti terzi. Certifica che il prodotto è conforme e rispetta i requisiti proposti dalla norma EN 60598 ed è progettato e realizzato in aziende il cui sistema di gestione della qualità soddisfa i requisiti della norma UNI EN ISO 9001:2015.

ENEC 03 - The label ENEC (Electrical Certification concerning European Standard) is a voluntary label granted by third organizations. It certifies that a product complies to the EN 60598 standards and has been designed and manufactured by companies with an approved UNI EN ISO 9001:2015 quality control system.



CE - Dichiaro che il produttore produce apparecchi conformi e rispondenti ai requisiti proposti dalla norma EN 60598/1.

CE - Declares that the manufacturer produces light fittings which comply with the requirements of the EN 60598.

Tutti gli apparecchi con sorgente LED sono stati testati secondo la norma IEC62471 o IEC/TR62778 vigenti (sicurezza fotobiologica delle lampade).

All the appliances with LED sources have been tested according to the courrent IEC62471 or IEC/TR62778 standards (photobiological safety of lamps).

SIMBOLI / SYMBOLS





TIPOLOGIA / TYPOLOGY

	LAMPADE DA TAVOLO TABLE LAMPS
	LAMPADE SOSPENSIONE SUSPENSION LAMPS
	LAMPADE DA TERRA FLOOR LAMPS
	LAMPADE DA PARETE WALL LAMPS
	LAMPADE DA SOFFITTO CEILING LAMPS

FAMIGLIE / FAMILIES

	LAMPADE DA TAVOLO TABLE LAMPS
	LAMPADE SOSPENSIONE SUSPENSION LAMPS
	LAMPADE DA TERRA FLOOR LAMPS
	LAMPADE DA PARETE WALL LAMPS
	LAMPADE DA SOFFITTO CEILING LAMPS

EMISSIONI LUCE / LIGHT EMISSION

	LUCE DIRETTA DIRECT LIGHT
	LUCE INDIRECTA INDIRECT LIGHT
	LUCE DIFFUSA DIFFUSED LIGHT
	LUCE ORIENTABILE SWIVELING LIGHT
	LUCE DIRETTA INDIRECTA DIRECT INDIRECT LIGHT

FASCI DI LUCE / LIGHT BEAMS

VERY NARROW	< 10°
NARROW	11-20°
MEDIUM	21-30°
WIDE	31-40°
VERY WIDE	> 40°

COLORI / COLORS

BI		bianco / white	AZ		azzurro / light blue
NE		nero lucido / glossy black			azzurro chiaro / light blue
GR		grigio / grey	VE		verde / green
		grigio chiaro / light grey			lime chiaro / light lime
		grigio scuro / dark grey			verde pistacchio / pistachio green
AU		dorato / golden			verde agave / agave green
		oro perlato / pearly gold	BL		blu / blue
CU		rame / copper			blu ottanio / octane blue
CP		rame perlato / pearly copper	GI		giallo / yellow
AL		alluminio / aluminium	AR		arancio / orange
OT		ottone / brass	BG		beige / beige
LU		lucido / polished	RO		rosso / red
TR		trasparente / transparent			rosso rubino / rubine red
TI		titanio / titanium			rosso porpora / purple red
SD		micaceo / micaceous	AN		antracite / anthracite
CO		corten / corten	CH		sabbia dorata / golden sand
CS		cartone / cardboard	FC		fucsia / fuchsia
MS		specchiato / mirrored			
MA		testa di moro / dark brown			

MARMO / MARBLE

MAR/CA	marmo carrara carrara marble
MAR/AR	marmo arabesque arabesque marble
MAR/MR	marmo marquinia marquinia marble

Per essere sempre informati sulle novità, oltre ai cataloghi "Lampade", "Architectural" e "Outdoor" è utile consultare le sezioni del nostro sito WEB ufficiale: www.martinelliluce.it, di facile consultazione e che viene aggiornato costantemente, per avere un riscontro veloce e approfondito alle vostre esigenze.

È possibile effettuare direttamente dal sito il download dei nostri prodotti in 3D e le relative curve fotometriche da utilizzare per i vostri progetti.

Martinelli Luce offre la massima collaborazione del proprio studio tecnico, per proporre al cliente soluzioni illuminotecniche anche per singoli progetti o risolvere problematiche specifiche.

To keep abreast of all these novelties, in addition to our "Lampade", "Architectural" e "Outdoor" catalogs, you can browse the different sections of our official website: www.martinelliluce.it.

User-friendly and constantly updated, it provides quick & in-depth answers to your needs.

Also, you can download our products in 3D and the relative photometric curves that you can use for your projects, directly from the website.

Martinelli Luce offers the full collaboration of its technical department, to propose customers lighting solutions also for individual projects or to help find answers to specific issues.

Elio Martinelli

e la Martinelli Luce



Electa



www.martinelliluce.it

Per conoscere meglio la storia di Martinelli Luce consultare il nostro sito web alla sezione storia o consultare il libro "Elio Martinelli e la Martinelli Luce" edito da Mondadori-Electa nel 2018.

To know more about the history of Martinelli Luce, visit our website in the history section or consult the book "Elio Martinelli e la Martinelli Luce" by Mondadori-Electa in 2018.

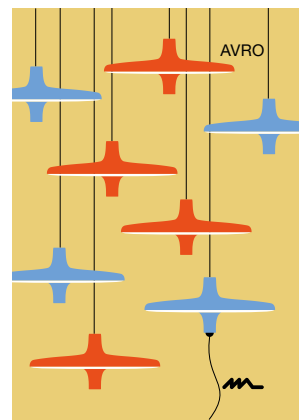
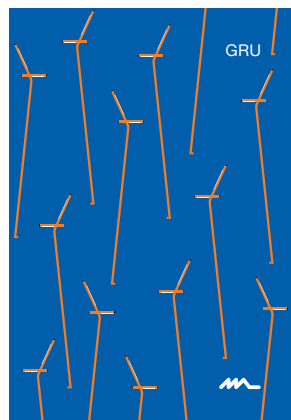
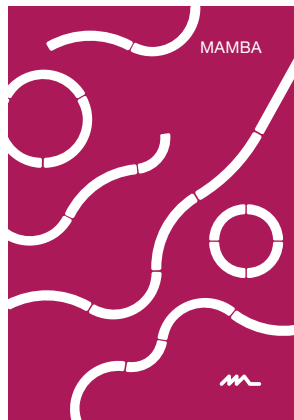
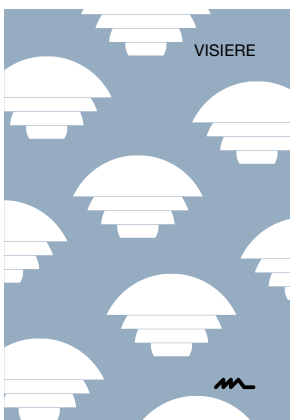
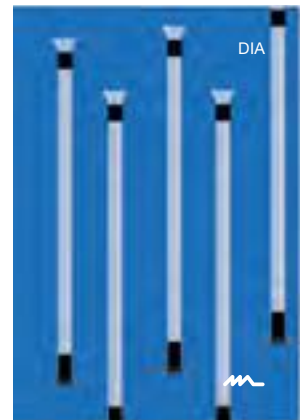
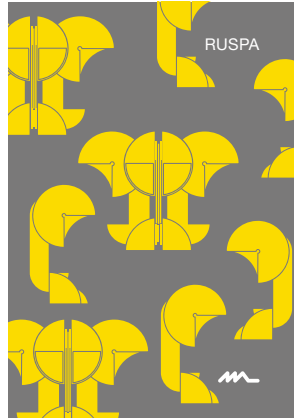
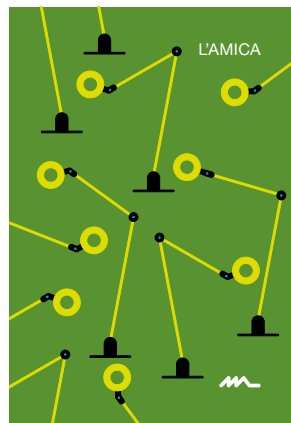
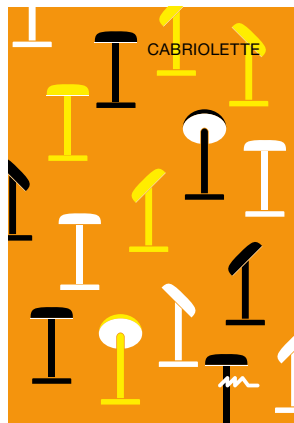
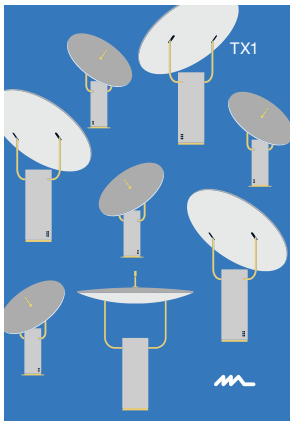

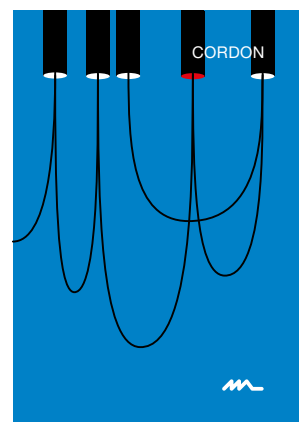
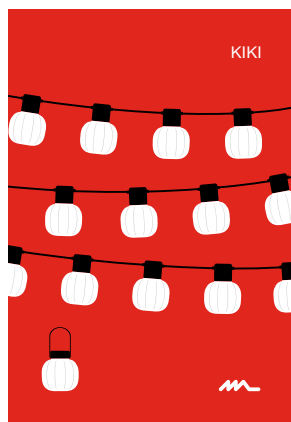
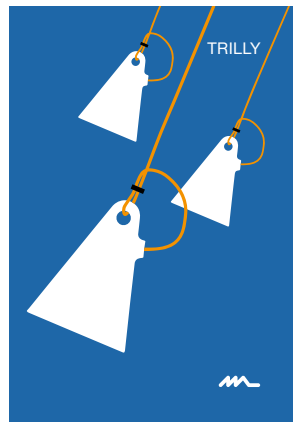
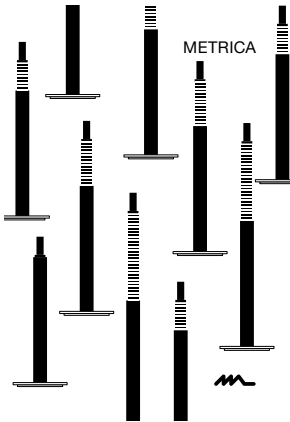
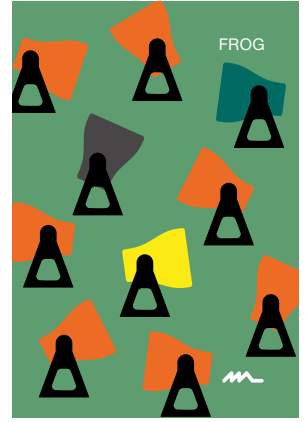
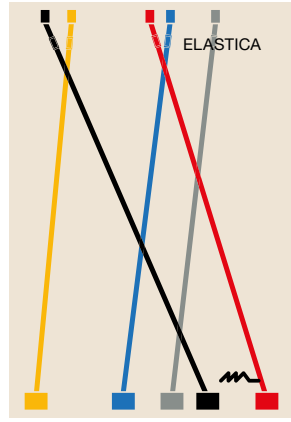
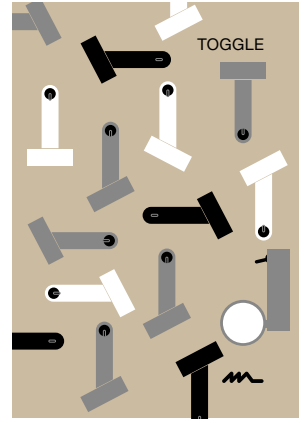
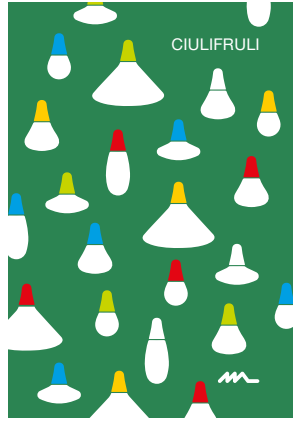



Tutti gli anni i nostri cataloghi,
lampade, architectural
e outdoor, si ampliano,
continuando a presentare
nuove soluzioni frutto di una
continua ricerca sui materiali
e le tecnologie, i colori e le
forme.

Every year our lighting,
architectural and outdoor
catalogues expand, continuing
to present new solutions which
are the result of continuous
research into materials and
technologies, colours and
shapes.

EDITION: 05/2022

Art direction:
Emiliana Martinelli

Layout:
Stefano Citti

Editing of text:
Emiliana Martinelli, Giovanni Silvano,
Luigi Maisto, Marco Ghilarducci.

Printing in Italy:
IMOCO - Treviso 2022

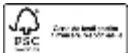

WALLS



martinelliluce.it